

D-Sub Connector

37P, Female



SPECIFICATION:

Poles	37
Termination	180°/Solder PCB THT
Gender of contacts	Female
A	69.4 mm
B	63.5 mm
C	54.8 mm
Colour	Black
Contact material	Brass, Gold-Flashed
D	12.5 mm
E	7.9 mm
Housing Material	Steel/Nickel (Ni)
Insulator material	PBT
Outside material	Metal
Rated current	3 A
Temperature range	-55...+105 °C

Art. Nr.

RND 205-00783

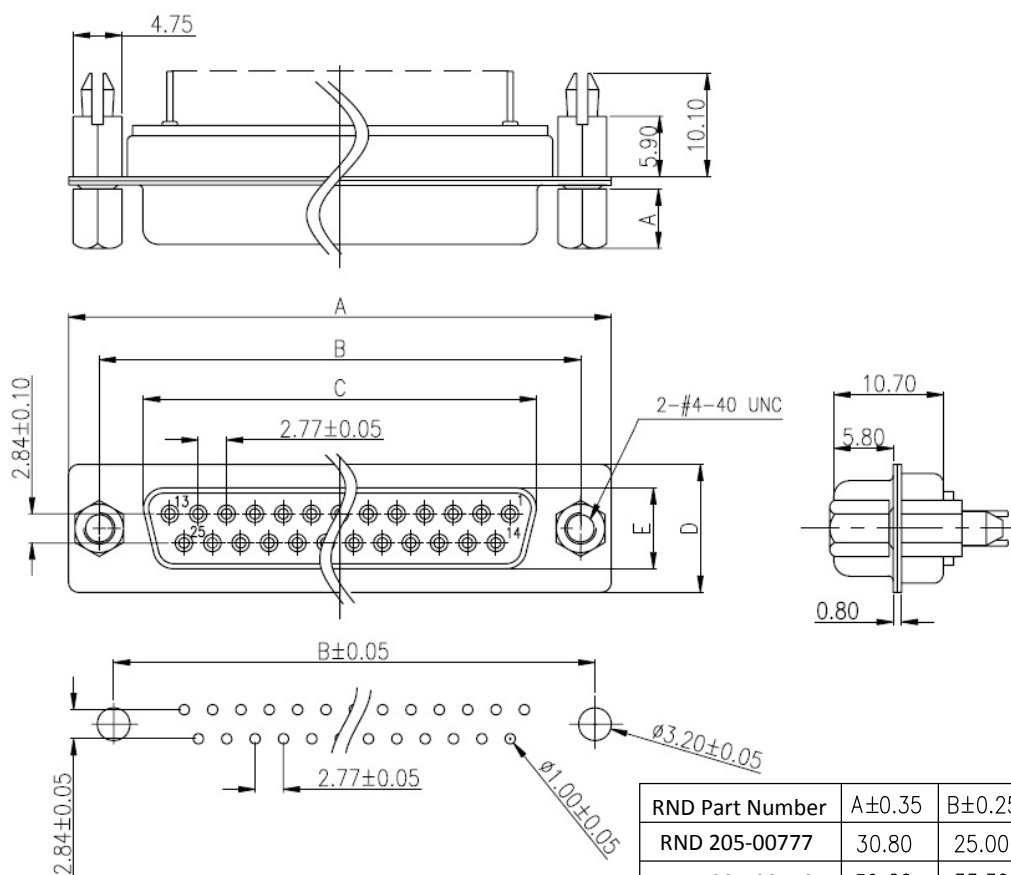

RND Part Number	A±0.35	B±0.25	C±0.25	D±0.25	E±0.10
RND 205-00777	30.80	25.00	16.30	12.50	7.90
RND 205-00779	39.20	33.30	24.60	12.50	7.90
RND 205-00781	53.05	47.05	38.30	12.50	7.90
RND 205-00783	69.40	63.50	54.80	12.50	7.90