

DC Power Plug

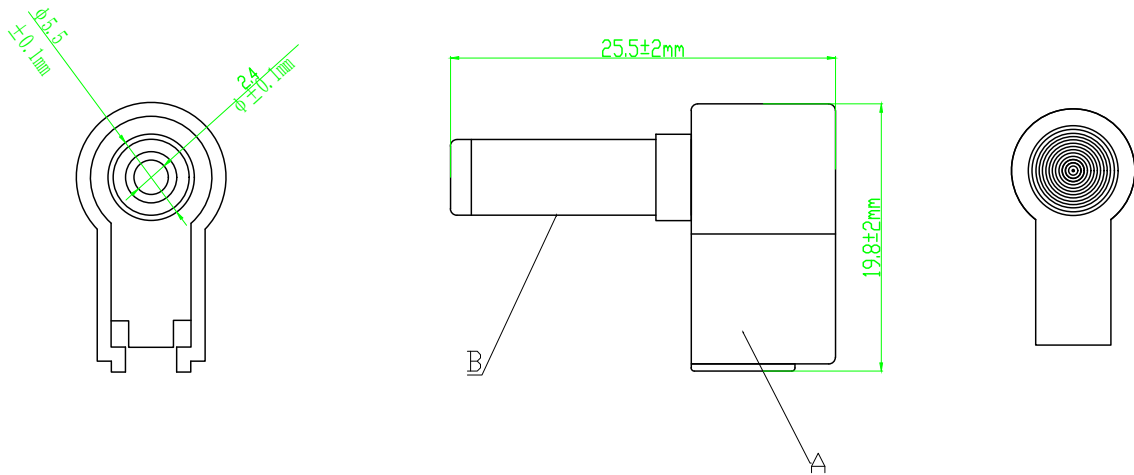

SPECIFICATION:

Body Orientation	Straight
Connector Mounting Type	Cable Mount
Termination Type	Solder Terminal
A (Housing)	PVC, Nickel Plated Iron Shell
B (Connector 1)	DC Power Plug 2.5*5.5mm



Art. Nr.
RND 205-00914