

Quick-Connect Terminal Block



Features

- Anti-creeping
- Anti-flaming & high-temperature resistance material
- Safer & easier install and operate
- Certification: CE, TUV



Mechanical Specification

Connection Capacity	IEC 0.5 ... 2.5 mm ² (Solid Wire)
Stripping Length	10 ... 12 mm
Number of Positions	6
Operating Temperature	-45 ... 80 °C

Electrical Specification

Voltage Rating	300 V
Current Rating	24 A
Contact Resistance	20 mOhm max.
Insulation Resistance	1 GOhm min. , 1 kV DC
Withstanding Voltage	2.5 kV AC, 1 min.

Material Specification

Body Material	Polycarbonate
Spring Clip	SUS 301
Conductor Material	Copper, Tin Plated
Cover Material	PA66, UL94-V0

Drawing

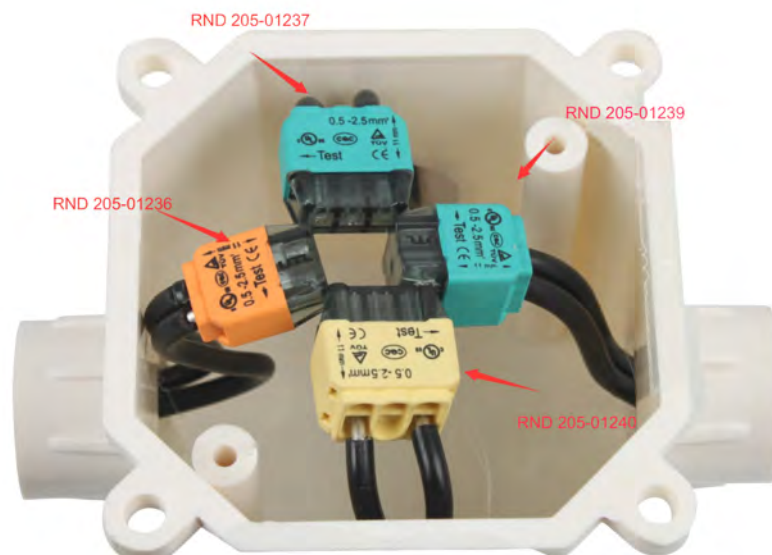
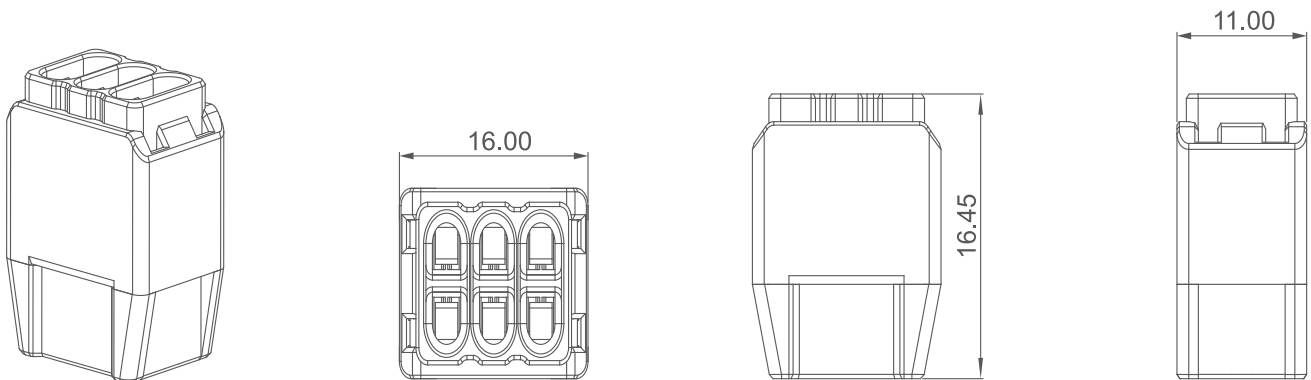

Art. Nr.
RND 205-01240