

# DIN Circular Connector



## Features

- Multiple pins within a protective circular sheath and cables that plug into an interface to connect devices
- Enables a secure signal and current transmission
- Can be used in various applications to connect devices including, personal computers, audio and video to power, serial and data



## Specification

Number of Poles	6 / 240°
Current Rating	1 A
Voltage Rating	100 V
Contact Resistance	Pins 30 mOhm max., Shell 50 mOhm max.
Insulation Resistance	100 MOhm @ 500 VDC
Voltage Withstand	250 VAC RMS for 1 min.
Gender	Jack
Mating Type	Bayonet
Mounting Type	Cable Mount
Orientation	Straight
Termination Type	Solder Terminal

## Material Specification

1 - Shell Cover	Zn Alloy, Nickel Plated
2 - "T" Cable Holder	Steel, Nickel Plated
3 - Setscrew	Steel, Nickel Plated
4 - Strain Boot	PVC
5 - Housing	PA66
6 - Contact Terminals	Brass, Silver Plated

## Drawing

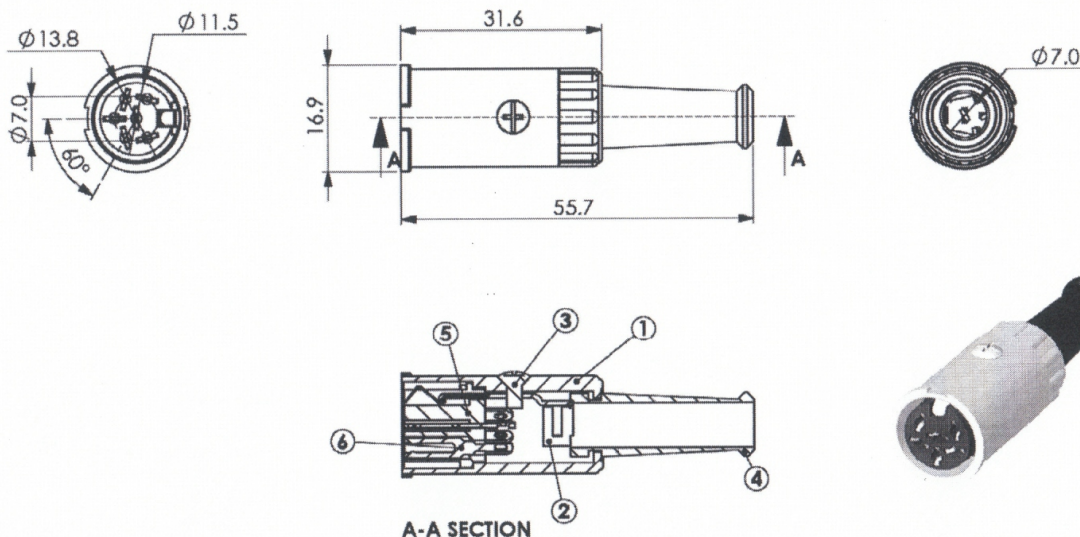

Art. Nr.  
RND 205-01466