

PCB Switch

PCB 12 VDC 50 mA black

SPECIFICATION:

Switching type	Momentary function
Switching type, ()momentary	(on)-off
Rated current	50 mA
Rated voltage	12 VDC
Actuation force	2.45 N
Button colour	black
Poles	1
Termination type	PCB
Connection	THT
Colour	black/grey
Contact material	Brass
Temperature range	-20...+70 °C
Construction form	Tact switch
Length	3.15 mm
Width	6 mm

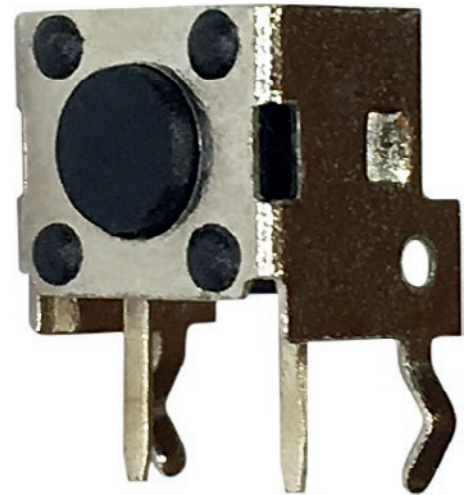

DRAWING

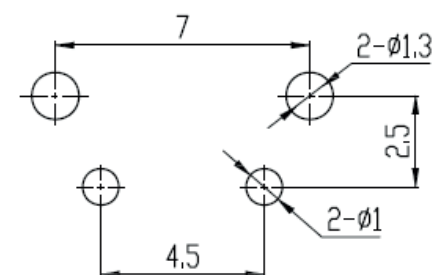
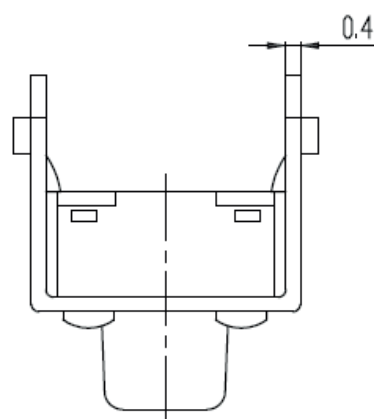
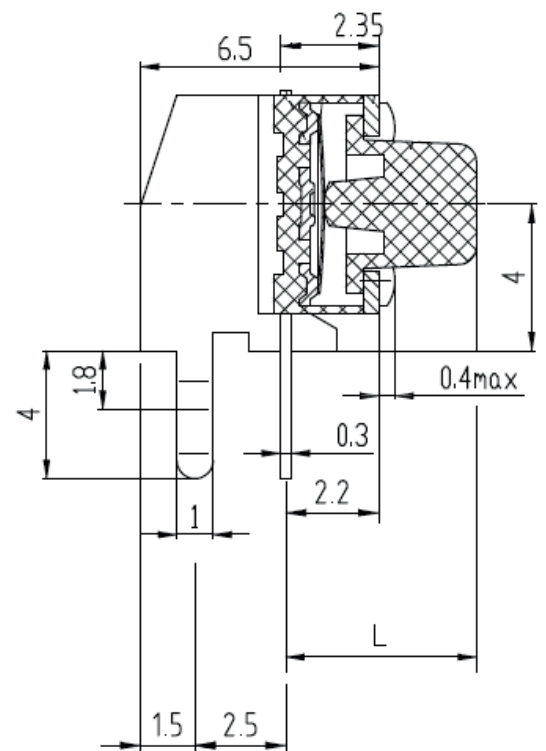
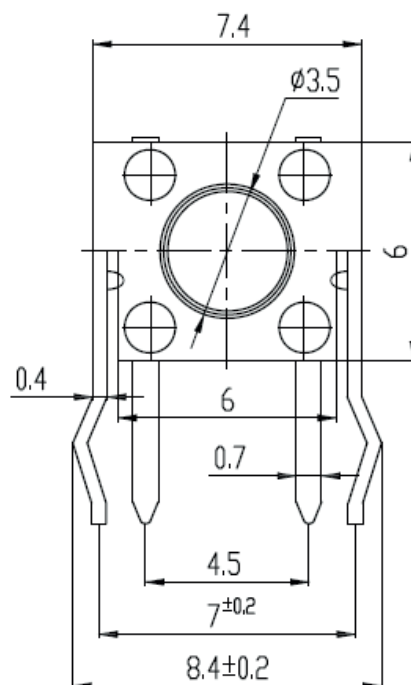

L = 3.15 mm

Type	DIM. "L"
RND 210-00256	.124 [3.15]
RND 210-00257	.152 [3.85]
RND 210-00258	.230 [5.85]
RND 210-00260	.329 [8.35]