

Micro Switch

Features

- Snap-action switch
- Micro switch with solder/PCB terminals
- Simple construction and high reliability for long time
- Robust design

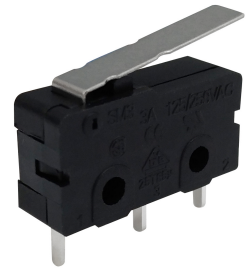

Functional Specification

Rated Voltage	125 VAC / 250 VAC
Rated Current	3 A
Contact Resistance	100 mOhm
Operating Force	38 ± 20 gf
Free Position	14.2 ± 1 mm
Operating Position	12.1 ± 1 mm
Actuator Type	Hinge Lever
Termination Type	PCB Terminals

Reliability Rating

Mechanical Life	1000000 Cycles
Electrical Life	10000 Cycles
Insulation Resistance	100 MOhm @ 500 VDC
Dielectric Withstanding Voltage	1 kVAC 1 min
Soldering Type	Hand Soldering
Operating Temperature	-25 ... 85 °C
Ambient Humidity	< 70%RH

Drawing

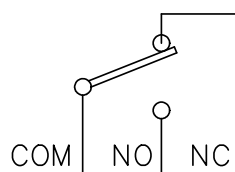
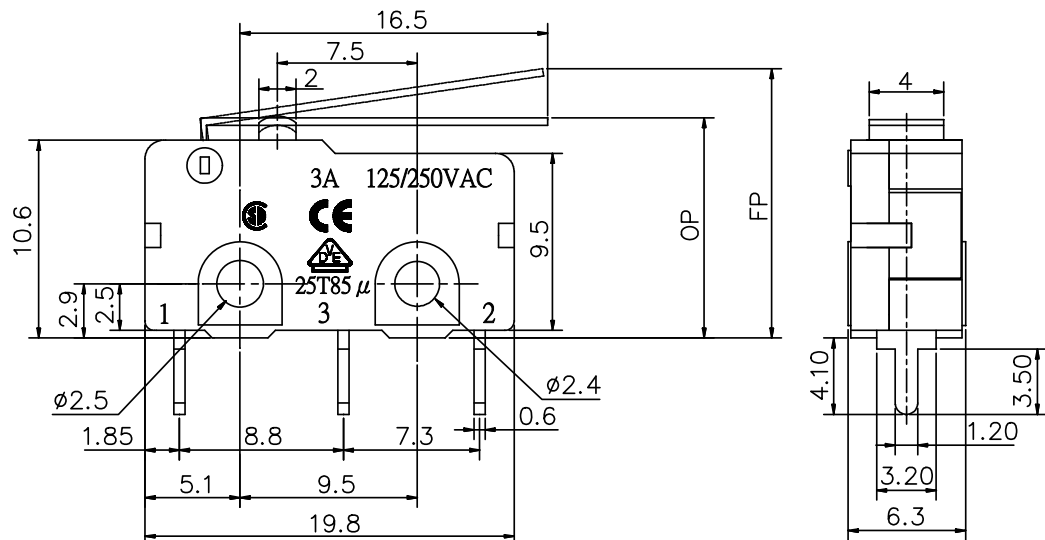

SCHEMATIC

Art. Nr.
RND 210-00752