

Inlet C14



SPECIFICATION:

Rating	10A 250V AC VDE 3C KC
Insert And Extract Force	1.36 kgf~6.8 kgf
Terminal Strength	≥80N
Operating Life	≥5000 cycles
Withstand Voltage	Between all terminals: 2500V AC (50-60Hz)1min Terminals to base: 3750V AC (50-60Hz)1min
Leakage Current	1mA
Insulation Resistance	≥100MΩ 500V DC
Body Material	Nylon 66 94V-2-0

Drawing

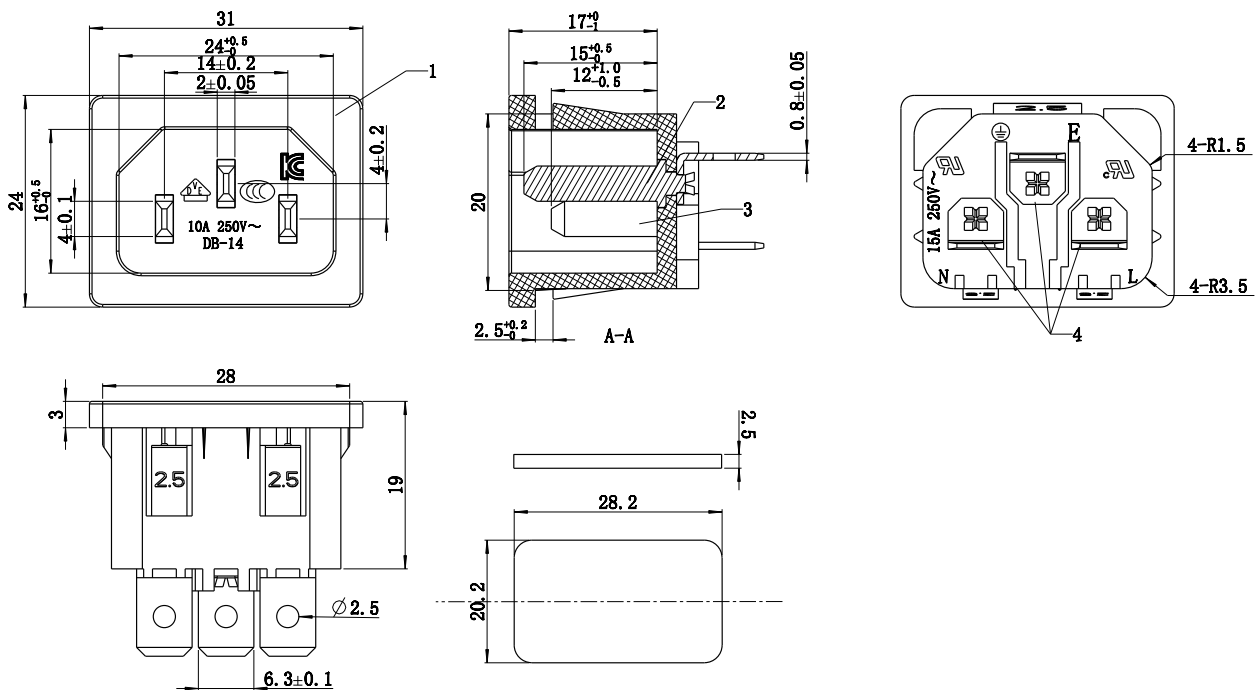

Art. Nr.

RND 465-00779