

# Mains Cable

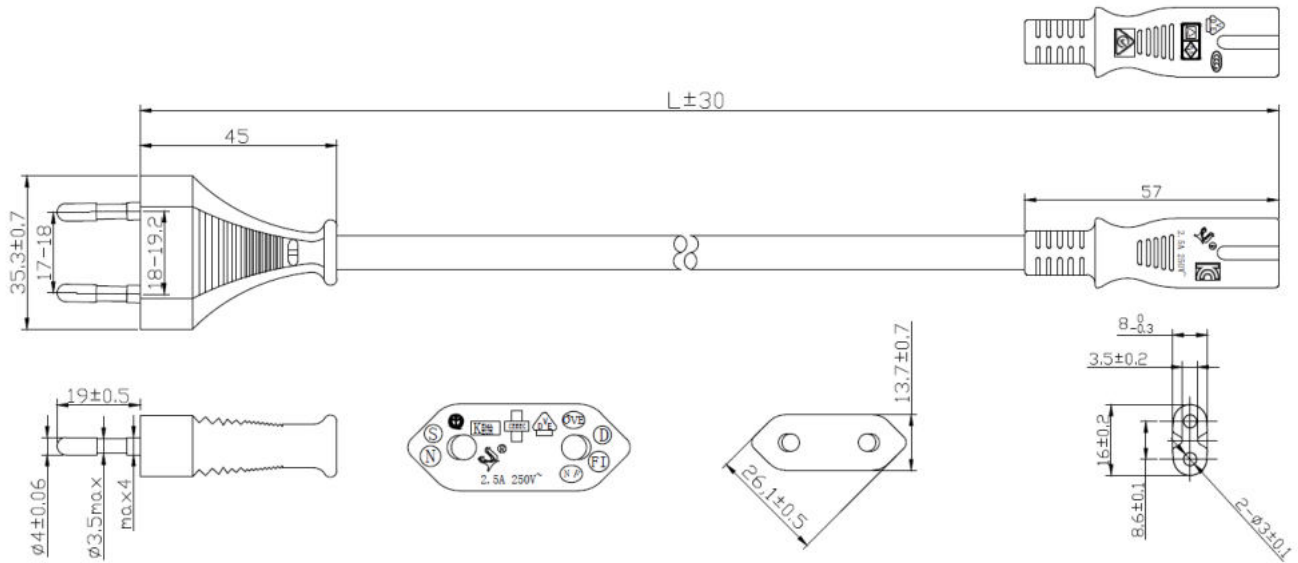

## Specification

Connector A	Euro Male
Connector B	IEC 60320 C7
Connector Orientation	Straight
Cross-Section	0.75 mm <sup>2</sup>
Current Rating	2.5 A
Jacket Colour	Black
Jacket Material	PVC
Length (L)	3 m
Voltage Rating Max.	250 V

### Notes:

- 1.Cable:H03VV2-F 2\*0.75<sup>2</sup>mm Jacket 3.5±0.1\*5.7±0.1 Conductor 24\*0.198
- 2.Mark:  $\triangleleft \text{VDE} \triangleright$  H03VVH2-F 2\*0.75mm<sup>2</sup>
- 3.Test:Hi-pot: Inner Voltage AC2500V/1S , External Voltage AC4500V/1S  
current leakage 1mA, insulation resistance no less than 50M  $\Omega$ , no strike out;

**Art. Nr.**  
**RND 465-00962**

## Product Range

Product name	Model specification	Remarks
RND 465-00961	H03VVH2-F 2*0.75mm <sup>2</sup> 2.0M	Black
RND 465-00962	H03VVH2-F 2*0.75mm <sup>2</sup> 3.0M	Black
RND 465-00963	H03VVH2-F 2*0.75mm <sup>2</sup> 5.0M	Black
RND 465-00964	H03VVH2-F 2*0.75mm <sup>2</sup> 3.0M	White
RND 465-00965	H03VVH2-F 2*0.75mm <sup>2</sup> 5.0M	White