

ESD Precision Pliers

Long/Flat Nose/Serrated, 130 mm



Features

- Designed for use with electronic applications
- Ideal for precision work
- Made of stainless steel
- Monocomponent ESD handle



Specification

Body material	S (AISI 410)
Grip handle material	Black plastic
Head shape	Flat Nose
Size/type	Long
Jaw	Serrated
OAL (mm - in) - A	130.00 - 5.118
B (mm - in)	25.00 - 0.984
Head width (mm - in) - C	11.50 - 0.453
Head thickness (mm - in) - D	7.50 - 0.295
E (mm - in)	1.40 - 0.055
F (mm - in)	1.00 - 0.039

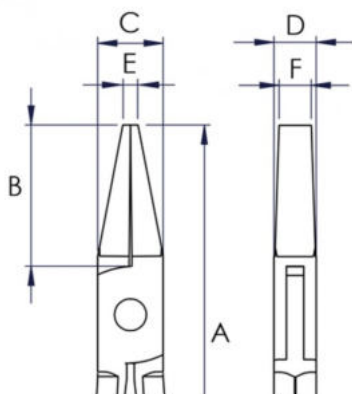

Art. Nr.
RND 550-00320