

Digital Sliding Caliper

Features

- Selectable inch / metric measurements
- Thumb wheel for accuracy and ease of use
- 4 measurements: inside, outside, depth and step
- Large LCD display
- When display screen flashes batteries need to be replaced



Specification

Measuring Range	0 .. 150 mm / 0 ... 6"
Resolution	0.01 mm / 0.0005"
Repeatability	0.01 mm / 0.0005"
Maximum Measuring Speed	1.5 m/s / 60 in/s
Measuring System	Non Contact Linear CAP Measuring System
LCD Display	5 Digits
Battery	1x LR44
Operating Temperature	0 ... 40°C
Storage Temperature	-10 ... 60°C
Relative Humidity	80% max.

Art. Nr.
RND 555-00206

RND 555-00167

6" ELECTRONIC CALIPER

OPERATING INSTRUCTIONS

● TECHNICAL SPECIFICATIONS

- Measuring range : 0~150mm/0~6".
- Resolution : 0.01mm/0.0005".
- Accuracy : $\pm 0.02\text{mm}/0.001"$ ($< 100\text{mm}$) , $\pm 0.03\text{mm}/0.001"$ ($> 100\text{mm}$).
- Repeatability : 0.01mm/0.0005".
- Max.measuring speed : 1.5m/sec. $\cdot 60"/\text{sec}$.
- Measuring system : Linear capacitive measuring system.
- Display : LCD display.
- Power : 1pc silver oxide battery LR44 (1.5V)
- Capacity : Appr. 165mAh
- Working temperatuer : 5~40 °C/41~104 °F.
- Influence of humidity : Not important under 80% of relative humidity.

● PRODUCT DESCRIPTION

1. Internal measuring jaws
2. Metric/Inch change button(mm/inch)
3. Locking screw
4. LCD display
5. External measuring jaws
6. Power on /off button(ON/OFF)
7. Zero setting(ZERO)
8. Battery cover
9. Depth measuring blade
10. Step-measuring faces
11. Data hold button(HOLD)

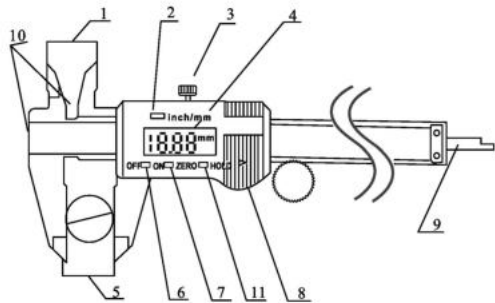

● OPERATION

1. Preparations :

- 1.1. Slider can be moved after the locking screw (No.3 item of the Nomenclature) is loosened.
- 1.2. Wipe clean all the measuring faces and caliper bar.No organic solutions are allowed.
- 1.3. Check to see if all the buttons, switches and LCD display respond well.

2. Basic measuring methods :

- 2.1. Loosen the locking screw.
- 2.2. Switch the unit on by pressing "ON/OFF" button, or move caliper slider for auto power on, then select the unit by pressing "mm/inch" button. (Each time the button is pressed, inch and metric digits will be displayed alternatively.)
- 2.3. Apply normal measuring pressure on slider to close the external.
- 2.4. Press Date hold(HOLD) button to keep measuring data in record.
- 2.5. Press "ON/OFF" button for power off. or the power will auto off when not in use for 5 minutes.

A. Measurements of internal dimensions.

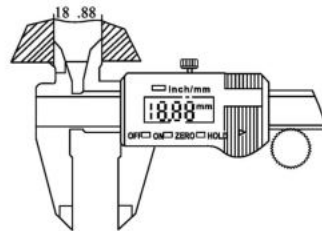

B. Measurements of external dimensions

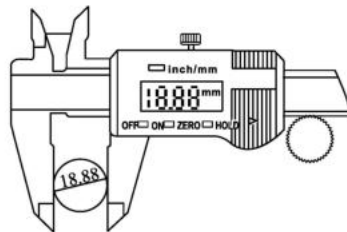

C. Measurements of depth.

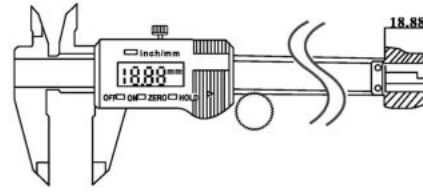

D. Measurement of steps.

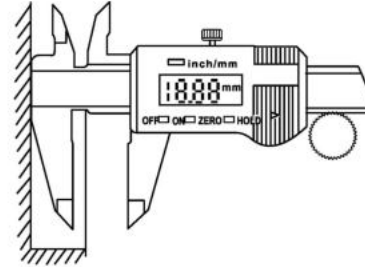

E. Differential method of measurement. (Application of zero setting.)

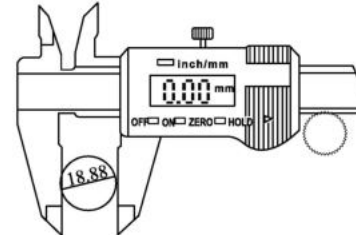
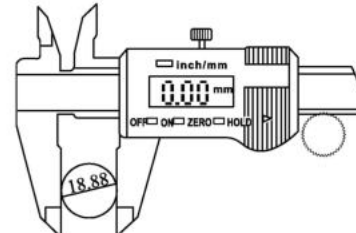

● MAINTENANCE

1. Clean caliper bar with dry cotton fabrics before using in order to avoid mad display of caliper caused by humidity.
2. Keep the caliper clean and dry. (Liquid can damage the slider.)
3. Faces should be cleaned gently with cotton fabrics. Never use petrol, acetone and other organic solutions.

4. In order to save power, turn off the unit when caliper is going to stay idle for some time.
5. Never apply any electric pressure on any part of the caliper and never use an electric pen for the fear of damaging its chip.
6. For other notes please refer to the conventional calipers.
7. Accidental wrong display may happen while replacing the battery Just take out the battery and then put it in again after more than 30 seconds until the display returns to normal.

● BATTERY REPLACEMENT

When the numbers on LCD display are not clear, take off the battery cover in the direction shown by the arrow and replace the battery. (positive side facing out.)

● TROUBLE SHOOTING

Failure	Cause	Solution
The numbers on LCD display are not clear	Battery voltage lower than 1.0V.	Replace the battery.
Display doesn't change when the slider is moved.	Accidental trouble in circuit.	Take out battery and reset it after 30 sec.
Less accurate than specified but with $-in \pm 0.1\text{mm}$.	Dirt in the sensor.	Remove slider cover and it's assembly, clean face of sensor with clean compressed air ($5\text{kg}/\text{cm}^2$).
No display on LCD.	1. Battery in poor contact. 2. Battery voltage under 1.0V.	1. Remove battery cover and adjust the battery seat, keep good connection. 2. Replace battery.