

SINAMICS BOP-2

Basic Operator Panel 2

Operating Instructions · March 2010



SINAMICS

SIEMENS

SIEMENS

SINAMICS

SINAMICS Basic Operator Panel 2 (BOP-2)

Operating Instructions



<u>Safety notes</u>	1
<u>Overview</u>	2
<u>Installation</u>	3
<u>Monitoring</u>	4
<u>Control</u>	5
<u>Diagnostics</u>	6
<u>Parameters</u>	7
<u>Setup</u>	8
<u>Extras</u>	9
<u>Technical data</u>	10

Edition 03/2010

Legal information

Warning notice system

This manual contains notices you have to observe in order to ensure your personal safety, as well as to prevent damage to property. The notices referring to your personal safety are highlighted in the manual by a safety alert symbol, notices referring only to property damage have no safety alert symbol. These notices shown below are graded according to the degree of danger.

 DANGER
indicates that death or severe personal injury will result if proper precautions are not taken.
 WARNING
indicates that death or severe personal injury may result if proper precautions are not taken.
 CAUTION
with a safety alert symbol, indicates that minor personal injury can result if proper precautions are not taken.
CAUTION
without a safety alert symbol, indicates that property damage can result if proper precautions are not taken.
NOTICE
indicates that an unintended result or situation can occur if the corresponding information is not taken into account.

If more than one degree of danger is present, the warning notice representing the highest degree of danger will be used. A notice warning of injury to persons with a safety alert symbol may also include a warning relating to property damage.

Qualified Personnel

The product/system described in this documentation may be operated only by **personnel qualified** for the specific task in accordance with the relevant documentation for the specific task, in particular its warning notices and safety instructions. Qualified personnel are those who, based on their training and experience, are capable of identifying risks and avoiding potential hazards when working with these products/systems.

Proper use of Siemens products

Note the following:

 WARNING
Siemens products may only be used for the applications described in the catalog and in the relevant technical documentation. If products and components from other manufacturers are used, these must be recommended or approved by Siemens. Proper transport, storage, installation, assembly, commissioning, operation and maintenance are required to ensure that the products operate safely and without any problems. The permissible ambient conditions must be adhered to. The information in the relevant documentation must be observed.

Trademarks

All names identified by ® are registered trademarks of the Siemens AG. The remaining trademarks in this publication may be trademarks whose use by third parties for their own purposes could violate the rights of the owner.

Disclaimer of Liability

We have reviewed the contents of this publication to ensure consistency with the hardware and software described. Since variance cannot be precluded entirely, we cannot guarantee full consistency. However, the information in this publication is reviewed regularly and any necessary corrections are included in subsequent editions.

Table of contents

1	Safety notes.....	7
2	Overview.....	9
3	Installation	15
4	Monitoring.....	17
5	Control.....	19
6	Diagnostics	23
7	Parameters	29
8	Setup.....	33
9	Extras	41
10	Technical data	47

Safety notes

Warnings and cautions

 WARNING
<ul style="list-style-type: none">• During commissioning of the Inverter it is essential to ensure that the system is in a safe and stable state, as some commissioning processes have the potential to start the motor. Therefore it is important to secure any loads and ensure that should the motor start, no potentially dangerous conditions exist.• The BOP-2 can be fitted to and removed from the inverter while power is applied.

Overview

Introduction

The Basic Operator Panel 2 (BOP-2) has been designed to enhance the interface and communications capabilities of SINAMICS Inverters.

The BOP-2 connects to the Inverter through an RS232 interface. It has been designed to automatically recognise all variants of the following Control Units from the SINAMICS range:

- SINAMICS G120 CU230P-2
- SINAMICS G120 CU240B-2
- SINAMICS G120 CU240E-2

Note

BOP-2 functional support

The BOP-2 has been designed to support all the above mention Control Units with firmware version 4.3 Service Pack 2 (SP2) or later.

Layout and functions

The physical layout of the BOP-2 is shown below:

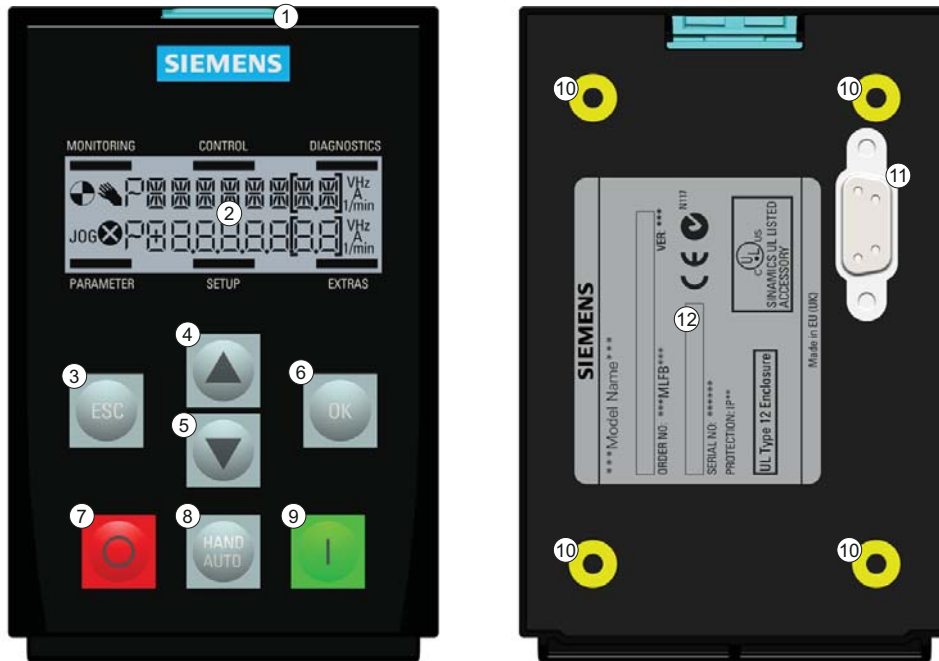









Figure 2-1 Layout of the BOP-2

Table 2- 1 Description of BOP-2 physical characteristics

Item	Description
①	Release catch
②	LCD screen
③	ESC key
④	Up key
⑤	Down key
⑥	OK key
⑦	OFF key
⑧	HAND/AUTO key
⑨	ON/Run key
⑩	Door mounting screw recess
⑪	RS232 connector
⑫	Product rating label

The specific functions of the keys are shown in the table below.

Table 2-2 Function of the BOP-2 controls

Key	Function
	<p>The OK key has the following functions:</p> <ul style="list-style-type: none"> • When navigating through the menus, pressing the OK key confirms selection of a menu item. • When working with parameters, pressing the OK key allows the parameter to be modified. Pressing the OK key again will confirm the entered value and return you to the previous screen. • In the faults screen it is used to clear faults.
	<p>The UP key has the following functions:</p> <ul style="list-style-type: none"> • When navigating a menu, it moves the selection up through the screens available. • When editing a parameter value it increases the displayed value. • If HAND mode is active and Jog is ON, a long press of the UP and DOWN key together has the following effects: <ul style="list-style-type: none"> – If reverse is ON, it switches the reverse function OFF. – If reverse is OFF, it switches the reverse function ON.
	<p>The DOWN key has the following functions:</p> <ul style="list-style-type: none"> • When navigating a menu, it moves the selection down through the screens available. • When editing a parameter value it decreases the displayed value.
	<p>The ESC key has the following functions:</p> <ul style="list-style-type: none"> • If pressed for less than 2 seconds the BOP-2 returns to the previous screen or if a value has been edited, the new value is not saved. • If pressed longer than 3 seconds the BOP-2 returns to the status screen. <p>When using the ESC key in the parameter editing mode, no data is saved unless the OK key is pressed first.</p>
	<p>The ON key has the following functions:</p> <ul style="list-style-type: none"> • In AUTO mode, the ON key is not active and if pressed it will be ignored. • In HAND mode the Inverter is started - the Inverter will display the drive running icon.
	<p>The OFF key has the following functions:</p> <ul style="list-style-type: none"> • In AUTO mode press the OFF key will have no effect and the key press will be ignored. • If pressed for longer than 2 seconds the Inverter will perform an OFF2; the motor will then coast down to a standstill. • If pressed for less than 3 seconds the following actions will be performed: <ul style="list-style-type: none"> – If the OFF key is press twice in less than 2 seconds on OFF2 will be performed. – If in HAND mode the Inverter will perform an OFF1; the motor will come to a standstill in the ramp-down time set in parameter P1121.
	<p>The HAND/AUTO key switches the command source between the BOP (HAND) and fieldbus (AUTO).</p> <ul style="list-style-type: none"> • If HAND mode is active, pressing the HAND/AUTO key will switch the Inverter to AUTO mode and disable the ON and OFF keys. • If AUTO mode is active, pressing the HAND/AUTO key will switch the Inverter to HAND mode and enable the ON and OFF keys. <p>Changing between HAND mode and AUTO mode is possible while the motor is still running.</p>

Note

Reaction to change between HAND and AUTO mode





When changing from HAND to AUTO mode the Inverter will react in the following way:

- If the ON signal is active the new setpoint will become active and the Inverter will automatically ramp the motor to the new setpoint after the change of mode.

When changing from AUTO to HAND mode the Inverter will react in the following way:

- The Inverter will not stop the motor running. The Inverter will run the motor at the same speed that was set prior to the  key being pressed. Any ramp function that was in progress will be stopped.



Locking and unlocking the keypad

To lock the BOP-2 keypad press  and  simultaneously for 3 seconds or more. To unlock the keypad press  and  simultaneously for 3 seconds or more.

Screen icons

The BOP-2 displays a number of icons at the left-hand side of the display to indicate the actual state of the Inverter. These icons are explained in the table below.

Table 2- 3 Screen icons description

Function	Status	Icon	Remarks
Command source	Hand		When the HAND mode is active the icon is displayed. When AUTO mode is active, no icon is displayed.
Inverter status	Inverter and motor running		This is a static icon and does not rotate.
Jog	Jog function is active	JOG	
Fault/alarm	Fault or alarm pending Flashing symbol = Fault Steady symbol = Warning		If a fault is detected, the Inverter will be stopped and the user is required to take the necessary corrective actions to clear the fault. An alarm is a condition that will not stop the Inverter, for example, overtemperature.

Menu structure

The BOP-2 is a menu-driven device and has the following menu structure:

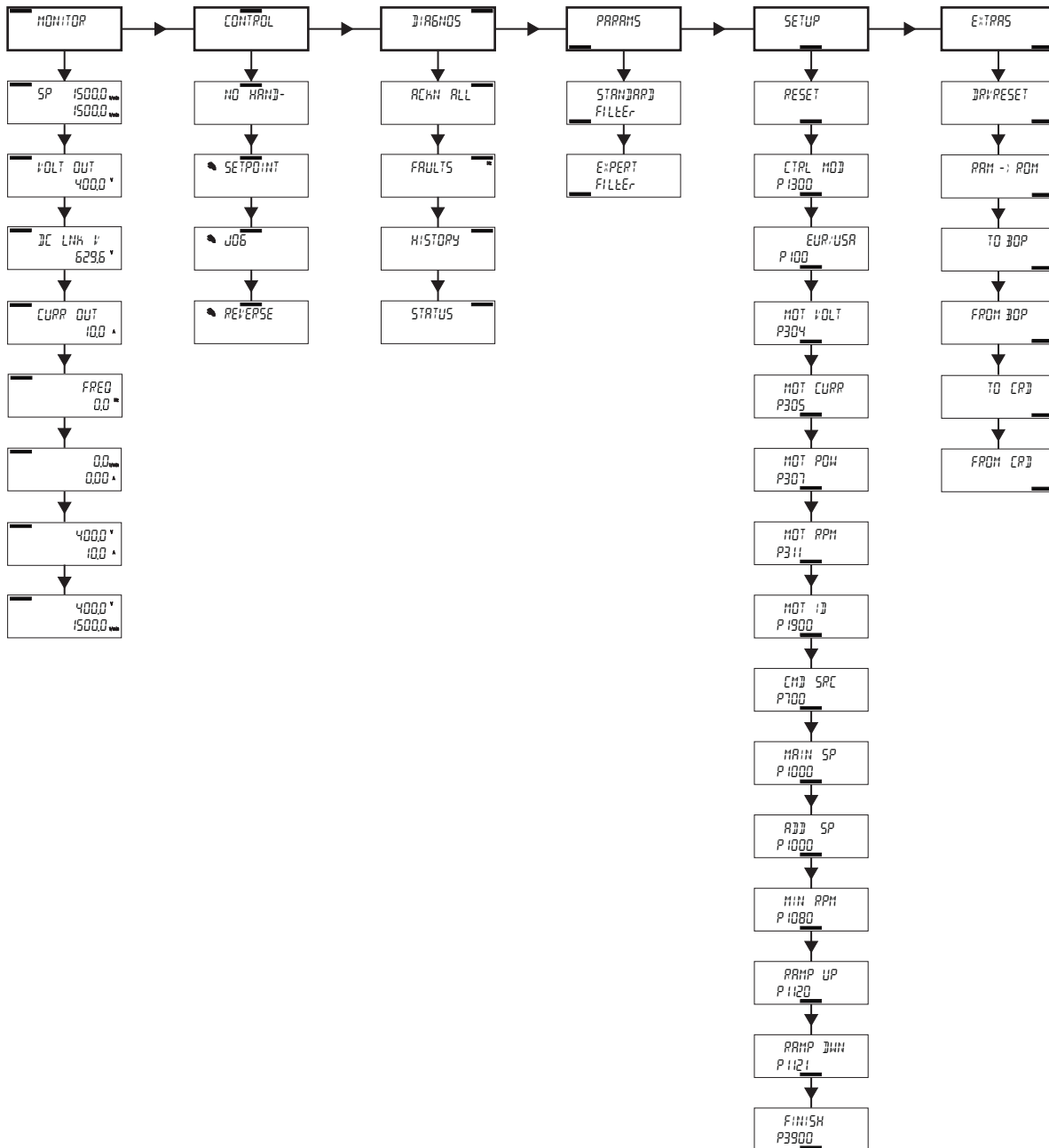

Figure 2-2 BOP-2 menu structure

Note

Menu structure and functionality

The actual menu structure and functionality of the BOP-2 is influenced by the following factors:

- The software version and type of Control Unit to which the BOP-2 has been fitted.
 - The firmware and software version of the BOP-2.
-

Fitting the BOP-2 to the Control Unit

Note

BOP-2 power supply

The BOP-2 has no internal power supply and derives its power directly from the Control Unit of the Inverter through the RS232 interface. Any cloned data stored on the BOP-2 will be saved to its non-volatile memory which does not require power to retain its data.

To fit the BOP-2 to the Inverter Control Unit the following procedure should be performed:

1. Place the bottom edge of the BOP-2 casing into the lower recess of the Control Unit housing.
2. Push the BOP-2 towards the Control Unit until the release-catch clicks into place on the Control unit housing.



Figure 3-1 Fitting the BOP-2 to the Control Unit

To remove the BOP-2 from the Control Unit, press down on the release-catch and pull the BOP-2 off the Control Unit.

Initial startup

Once the BOP-2 is fitted and powered-up it will automatically detect the type of Control Unit to which it has been fitted and attempt to automatically establish communications.

On startup the BOP-2 will display the company name and the class of Operator Panel.

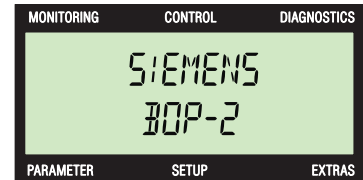

The BOP-2 will then display the current software version of the Operator Panel.



The BOP-2 will then establish communications between the Operator Panel and the attached Control Unit.



Once communications have been established, an internal check is performed to ensure that the Operator Panel is responding correctly.



Once all checks have been completed the BOP-2 will display the standard status screen. The BOP-2 is now ready for use.

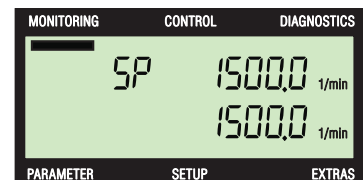

If after establishing communications there is a pending fault or alarm, the BOP-2 will display the relevant fault or alarm number.

If there is more than one fault or alarm, use the ▲ and ▼ keys to move through the list on the screen.

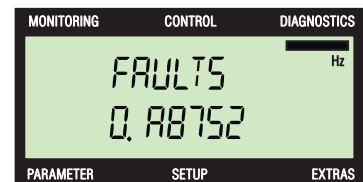

Monitoring

4

Overview

The Monitor menu allows the user to easily access a variety of screens which display the actual status of the Inverter/motor system.

The menu is selected by using the ▲ and ▼ keys to move the menu bar to the required menu.

Pressing **OK** will confirm the selection and display the top level menu.



Use the ▲ and ▼ keys to scroll through the various screens.

The information displayed in the Monitoring screens is read-only and cannot be modified.

The screens and the information they display are explained individually in the next section.

Monitoring screen information

The details of the information displayed by the various monitoring screens are described below.

The default screen shows the value set for the setpoint, below this value the actual speed of the motor is displayed.

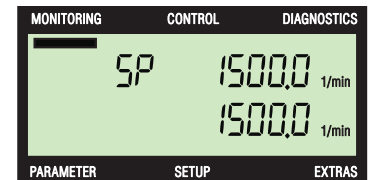

The voltage out screen displays the actual voltage output of the Inverter that is being supplied to the connected motor.



The DC Link screen displays the actual direct voltage across the DC Link terminals.

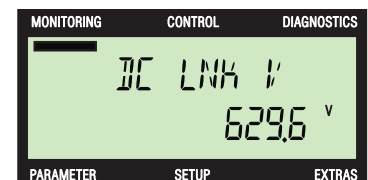

The current output screen shows the actual Inverter current output to the motor.



This screen shows the actual frequency (in Hz) at which the motor is running.

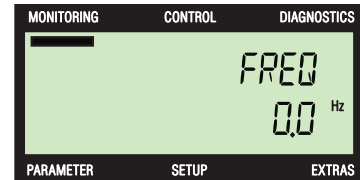

This screen displays the actual rotational speed of the motor in RPM and the actual output current of the Inverter to the motor.

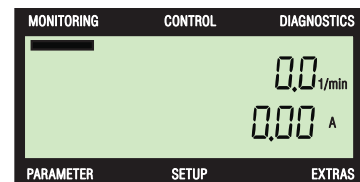

The voltage and current screen displays the actual voltage being supplied by the Inverter to the motor and the actual current out of the Inverter to the motor.



The voltage and rpm screen display the actual voltage being supplied by the Inverter to the motor and the actual speed of the motor in rpm.

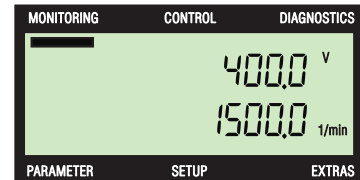

Control

5

Introduction

The control menu allows the user to access the following functions of the Inverter:

- Setpoint
- Jog
- Reverse

The menu is selected by using the ▲ and ▼ keys to move the menu bar to the required menu.

Pressing OK will confirm the selection and display the top level menu.



The Inverter must be in HAND mode before any functions can be accessed. If HAND mode is not selected a notice screen is displayed stating that the Inverter is not in HAND mode.

The HAND mode is selected by pressing the  key.



Use the ▲ and ▼ keys to scroll through the various screens.

Press OK to select the required function.

Note

Hand/Auto mode

If the  key is pressed when the Inverter is in AUTO mode, the user is taken directly to the Setpoint screen.



The individual functions are described below.

Setpoint









The setpoint value determines the speed at which the motor runs as a percentage of the nominal motor speed. It should be noted that this setpoint setting is only valid while HAND mode is selected. When the Inverter is set back to AUTO mode, the setpoint previously used in AUTO mode becomes the valid setpoint.

Note

Torque setpoint







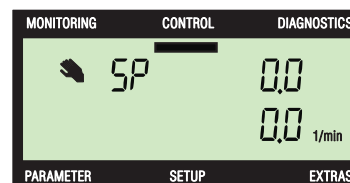



In HAND mode the torque setpoint (if the Inverter is in torque control mode) cannot be directly modified using the setpoint speed function of the BOP-2; although the motor can still be stopped and started using the  and  keys respectively.

To change the setpoint, the following actions should be performed:

1. Pressing  at any time will automatically take the user to the Setpoint screen.
2. Press  to select the Setpoint function.
3. The actual value of the Setpoint is displayed.
4. Using the  and  keys to increase or decrease the displayed value respectively.
5. As the value of the setpoint is changed the actual RPM is shown below the setpoint value.
6. Press  to see the setpoint value in relation to current.
7. Press  to see the setpoint value in relation to voltage.
8. Press  to see the setpoint value in relation to RPM.
9. Press  to return to the top level setpoint screen.



To edit individual digits:

1. Press  until the screen changes to "SP DIGIT".
2. Press  or  to change the sign of the setpoint value.
3. Press  to accept the change.
4. The next digit will start flashing,
5. Press  or  to change the value of the digit.
6. Press  to accept the change.
7. The next digit will start flashing.
8. Continue this process until the digits have been changed to the required values.
9. When the final digit is changed and accepted by pressing , the setpoint screen is displayed.
10. The setpoint value will continue to flash to indicate that the value can still be changed by using the  or  to change the value.
11. Press  to return to the top level setpoint screen.

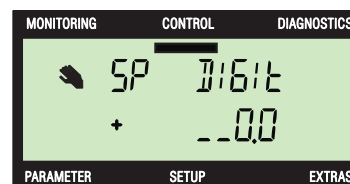

Jog

the Jog function, when selected will allow the motor to be manually rotated by a pre-determined value with each press of **J**. If **J** is pressed continuously, the motor will rotate continuously until **J** is released.

To enable or disable the Jog function, the following actions should be performed:

1. Using the **▲** and **▼** keys navigate to the Jog screen.
2. Press **OK** to select the Jog function.
3. Using the **▲** or **▼** keys to select ON.
4. Press **OK** to accept the change.
5. When the Jog function has been activated, the JOG symbol will be displayed in bottom left-hand side of the screen.
6. When the **J** is pressed the motor will run, until the **J** key is released.
7. Using the **▲** or **▼** keys to select OFF option.
8. Press **OK** to switch the Jog function OFF.
9. The JOG symbol will be removed from the screen.
10. Press **ESC** to return to the top level Jog screen.



Note

Reverse function

When the JOG function has been activated; pressing **▲** and **▼** together for more than 3 seconds will toggle to REVERSE function.

Reverse

The function of the reverse command is to set the direction of rotation of the motor from its normal forward motion.

To reverse the direction of the motor, the following actions should be performed:

1. Using the **▲** and **▼** keys navigate to the Reverse screen.
2. Press **OK** to select the Reverse function.
3. Using the **▲** and **▼** keys select ON or OFF.
4. Press **OK** to accept the change.

Pressing **ESC** for more than 3 seconds at any point during this sequence will cause the BOP-2 to return to the the default status screen.

The BOP-2 will remain in HAND mode until the **HAND AUTO** key is pressed.

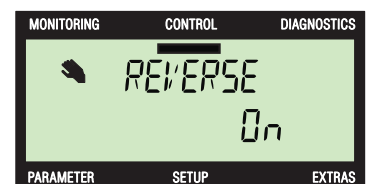

Diagnostics

Diagnostic menu

The Diagnostics menu allows the user to access the following function:

- Acknowledge all faults
- Faults
- History
- Status

To access the Diagnostics menu, the following actions should be performed:

1. Using the ▲ and ▼ keys navigate to the Diagnostics screen.
2. Press **OK** to select the Diagnostics menu.
3. Using the ▲ and ▼ keys select the required screen.
4. Press **OK** to display the selected screen.

Pressing **ESC** for more than 3 seconds at any point during this sequence will cause the BOP-2 to return to the status screen. A short press of the **ESC** key will cause the BOP-2 to return to the previous screen.

The individual functions are described below.



Acknowledge faults

When a fault condition occurs within the Inverter/motor system; the system is stopped by the Inverter and requires that all faults are acknowledged before restarting the system.

To acknowledge all active faults within the Inverter/motor system, the following procedure should be performed:

1. Using the ▲ and ▼ keys navigate to the Diagnostics screen.
2. Press **OK** to select the Diagnostics menu.
3. Using the ▲ and ▼ keys select ACKN ALL screen.
4. Press **OK** to acknowledge all active faults.
5. The BOP-2 will automatically return to the top level diagnostic menu.

Pressing **ESC** for more than 3 seconds at any point during this sequence will cause the BOP-2 to return to the status screen. A short press of the **ESC** key will cause the BOP-2 to return to the previous screen.



Active faults and alarms

When the Inverter detects a fault or alarm condition it maintains a list of all the currently active faults and alarms. For a detailed explanation of the displayed fault and alarm numbers, please refer to the relevant Parameter List.

To see which faults and alarms are currently active, the following procedure should be performed:

1. Using the ▲ and ▼ keys navigate to the Diagnostics screen.
2. Press **OK** to select the Diagnostics menu.
3. Using the ▲ and ▼ keys select the FAULTS screen.
4. Press **OK** to display the selected screen.
5. Using the ▲ and ▼ keys scroll through the faults and alarm list.
6. Press **OK** to clear faults.
7. Press **ESC** will return the BOP-2 to the ACKN ALL screen.

Note:

If a fault occurs, the dynamic fault screen will be displayed automatically.

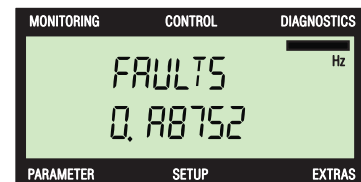

History

The History option within the Diagnostics menu maintains a list of the last 64 faults that have occurred within the Inverter/motor system. For a detailed explanation of the displayed fault and alarm numbers, please refer to the relevant Parameter List.

To access the History option, the following procedure should be performed:

1. Using the ▲ and ▼ keys navigate to the Diagnostics screen.
2. Press **OK** to select the Diagnostics menu.
3. Using the ▲ and ▼ keys select the HISTORY screen.
4. Press **OK** to display the selected screen.
5. Using the ▲ and ▼ keys scroll up or down through the list of recorded faults and alarms.
6. Press **ESC** to return to the Diagnostic top level menu.



Status

The Status option displays the actual state of the control words and status words that are used to control and monitor various functions of the Inverter. Information regarding the control words and the status words can help diagnose problems with the Inverter.

This options displays the current state of the following control and status words:

- Control word 1
- Control word 2
- Status word 1
- Status word 2

The various screens displayed in this menu option are read-only and cannot be modified.

To access the Status options, the following procedure should be performed:

1. Using the ▲ and ▼ keys navigate to the Diagnostics screen.
2. Press **OK** to select the Diagnostics menu.
3. Using the ▲ and ▼ keys select the STATUS screen.
4. Press **OK** to display the selected screen.
5. Using the ▲ and ▼ keys scroll up or down through the various status screens.
6. Press **ESC** to return to the Diagnostic top level menu.

The various status screens are explained below

Control word 1 lower bits

The control words consist of 16 bits of data and the first 8 bits are displayed as shown opposite.



Control word 1 higher bits

The last 8 bits of the control word data is displayed.



Control word 1 hexadecimal value

The value of control word 1 is displayed as a hexadecimal value.



Control word 2 lower bits

The control words consist of 16 bits of data and the first 8 bits are displayed as shown opposite.



Control word 2 higher bits

The last 8 bits of the control word data is displayed.



Control word 2 hexadecimal value

The value of control word 2 is displayed as a hexadecimal value.



Status word 1 lower bits

The status words consist of 16 bits of data and the first 8 bits are displayed as shown opposite.



Status word 1 higher bits

The last 8 bits of the status word data is displayed.



Status word 1 hexadecimal value

The value of status word 1 is displayed as a hexadecimal value.



Status word 2 lower bits

The status words consist of 16 bits of data and the first 8 bits are displayed as shown opposite.



Status word 2 higher bits

The last 8 bits of the status word data is displayed.

**Status word 2 hexadecimal value**

The value of status word 2 is displayed as a hexadecimal value.



For further information regarding the individual bits of data displayed on the screens, please refer to the relevant Parameter List under the following parameter numbers:

- r0052 - Actual status word 1
- r0053 - Actual status word 2
- r0054 - Actual control word 1
- r0055 - Actual control word 2
- r0056 - Status of motor control

Parameters

Parameter menu

The Parameter menu allows access to view and change the parameters of the Inverter.

There are two filters available to assist in the selection and searching of all the Inverter parameters, these are:

- Standard filter - this filter gives access to the most commonly used parameters for the specific type of Control Unit to which the BOP-2 is fitted.
- Expert filter - this filter gives access to all the Inverter parameters.

On first-time use, that is, the BOP-2 has been fitted to the Control Unit and power is applied, then the first parameter shown is the lowest numbered parameter which is r0002 or whichever is the lowest parameter number for the specific type of Control Unit to which the BOP-2 is fitted.

After this first-time use, when the parameters are next accessed, the last viewed parameter will be shown on the display.

The parameters can be addressed by the following methods:

- Parameter number
- Parameter number and index number
- Parameter number and bit number
- Parameter number, index number and bit number.

 CAUTION
<p>Action on fault during parameter editing</p> <p>If a fault occurs during parameter editing, the fault screen must be exited by pressing ESC or OK in order to allow the editing cycle to be completed.</p> <p>On a Safety Parameter Reset the Inverter MUST be power-cycled after the fault screen has been exited.</p>

There are two methods to select a parameter:

1. Using the **▲** and **▼** keys to scroll up and down through the displayed parameters.
2. A long press (more than 3 seconds) of the **OK** key will allow the user to input the required parameter number.

Using either of these methods pressing **OK** once will display the required parameter and the current value of the parameter.

Pressing **ESC** for more than 3 seconds at any point during this sequence will cause the BOP-2 to return to the top of the Monitor menu.

A short press of the **ESC** key will return to the previous screen. No changes will be saved.

The basic layout and functionality of the Parameter menu is shown below.

1. Using the ▲ and ▼ keys navigate to the Parameter menu.
2. Press **OK** to select the Parameter menu.
3. Using the ▲ and ▼ keys select the required filter.
4. Press **OK** to confirm the selection of the parameter filter.

There are two methods to edit parameters; editing by single digit or scrolling. Both methods are described below.

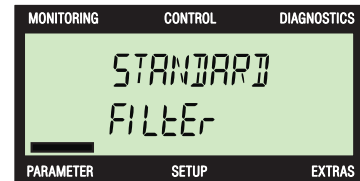
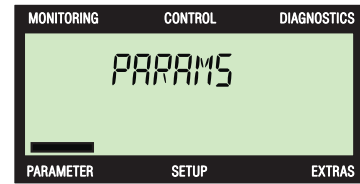

Editing parameters (single digit)

1. Press and hold **OK** until the parameter number flashes.
2. Using the **▲** and **▼** keys to modify the first digit value.
3. Press **OK** to accept the modified value.
4. The next digit in the sequence will start flashing.
5. Press **OK** to accept the modified value.
6. The next digit in the sequence will start flashing.
7. Continue the sequence until all digits have been modified to the required number.
8. On the final press of **OK** the parameter will be displayed or the nearest parameter number to the entered parameter number will be displayed.
9. Press **OK** to edit the displayed parameters value.
10. Press and hold **OK** until the parameter value flashes.
11. Using the **▲** and **▼** keys to modify the first digit value.
12. Press **OK** to accept the modified value.
13. The next digit in the sequence will start flashing.
14. Press **OK** to accept the modified value.
15. The next digit in the sequence will start flashing.
16. Continue the sequence until all digits have been modified to the required number.
17. On the final press of **OK** the modified value will be accepted.
18. To modify more parameters repeat steps 1 to 17.
19. When all the required parameters have been modified then - Press **ESC** to return to the previous screen or a long press to return the the top of the Monitor menu.

Notes:

- Pressing **ESC** once during single digit entry with restart the single digit entry. That is, if you are on the fifth digit and press **ESC** then it will return you to first digit.
- Pressing **ESC** twice during single digit entry will exit the single digit entry mode.
- Both method of editing, that is, scrolling or single digit entry can be used to edit any value displayed such as parameters, indexes and setup values.

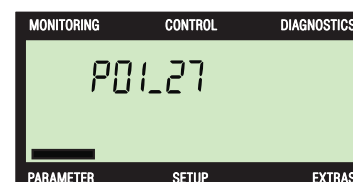

Editing parameters (scrolling)

1. Using the ▲ or ▼ keys to scroll to the required parameter number.
2. Press **OK** to select the parameter.
3. The parameter value will start flashing.
4. Using the ▲ or ▼ keys to change the parameter value.
5. Press **OK** to accept the modified value.
6. The parameter number will start flashing.
7. Using the ▲ and ▼ keys scroll through the parameter numbers to modify another parameter.
or
8. Press **ESC** to return to the previous screen.
or
9. A long press of **ESC** to return to the top of the Monitor menu.

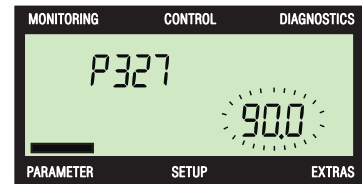
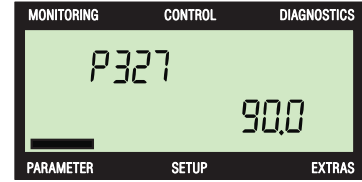

Setup menu

The setup menu is a fixed sequence of screens that allow the user to perform the basic commissioning of the Inverter.

Once a parameter value has been modified, there is no possibility to cancel the basic commissioning process. In this case, the basic commissioning process must be completed. If no parameter value has been modified, then a short press of **ESC** will return to the previous screen and a long press (more than 3 seconds) of **ESC** will return to the top of the Monitor menu.

When a parameter value has been modified and the new value confirmed by pressing **OK**, then the next parameter in the basic commissioning sequence is automatically displayed.

Editing parameters

Parameters can be modified use two methods; scrolling through the parameter values or using the single digit methods. Both these methods are described in section 7 of this manual.

Basic commissioning

Note

Maximum motor RPM (Parameter P1082)

The maximum motor RPM will not be required to be entered by the user during the basic commissioning process. The maximum motor RPM is automatically calculated during the motor calculation phase of basic commissioning. Should the user wish to view or edit parameter P1082, it is still available through the "Parameter" menu.

The basic commissioning process will require the input of data which is specific to the motor to which the Inverter is connected. The data regarding the attached motor can be gathered from the motor's rating plate. An example of a typical motor rating plate is shown in the figure below:

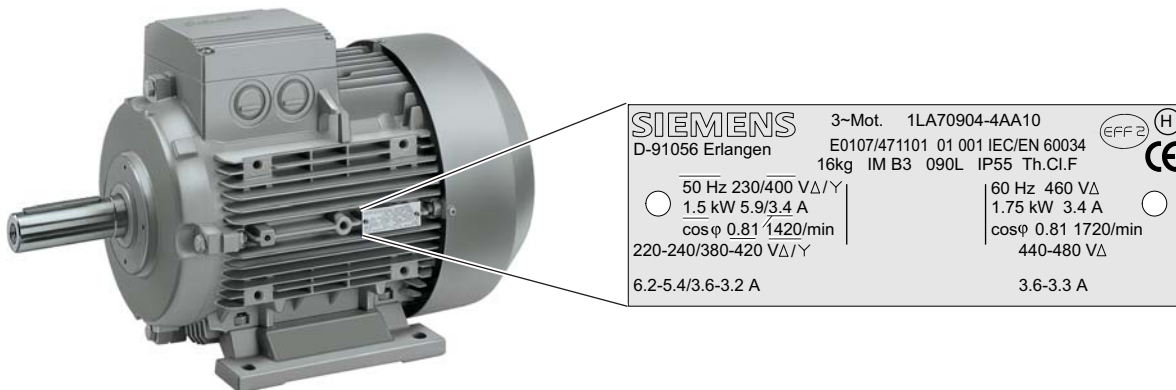

Figure 8-1 Motor Plate Information, 1.5 kW

The basic commissioning procedure is shown below.

Setup Menu

1. Using the ▲ and ▼ keys navigate to the Setup menu.
2. Press **OK** to start the basic commissioning sequence.



Reset

1. Using the ▲ and ▼ keys select Yes or No to reset the Inverter.
2. Press **OK** to confirm selection.
3. The display will automatically display the next parameter in the commissioning sequence.



The reset will be performed immediately. The reset will ensure that all parameter values are set to their default values before applying the new parameter values from the commissioning process.

Control mode

Sets the open and closed loop control mode of the Inverter.

1. Press **OK** to modify the parameter value.
2. Using the ▲ and ▼ keys scroll up or down the list until the required control mode is displayed.
3. Press **OK** to confirm the selected control mode.
4. The display will automatically display the next parameter in the commissioning sequence.

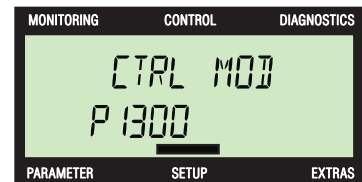

The available control modes are described below.

V/f control with linear characteristics.



Torque control without an encoder.



Speed control without an encoder.



V/f control with independent voltage setpoint.

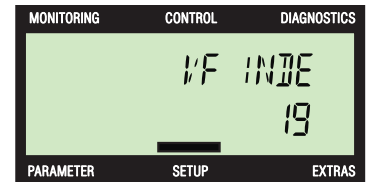

V/f control for a parabolic (quadratic) characteristic and Energy Control Optimization (ECO).



V/f control for Inverters requiring a precise frequency and Flux Current Control (FCC).



V/f control for Inverters requiring a precise frequency.



V/f control with linear characteristic and Energy Control Optimization (ECO).



V/f control with parameterizable characteristics.



V/f control with parabolic (quadratic) characteristics.



V/f control with linear characteristics and Flux Current Control (FCC).



Motor data

Sets the regional settings for the motor, for example kW and Hz.

1. Press **OK** to modify the parameter value.
2. Using the **▲** and **▼** keys scroll up or down the list until the required units are displayed.
3. Press **OK** to confirm the selected value.
4. The display will automatically display the next parameter in the commissioning sequence.

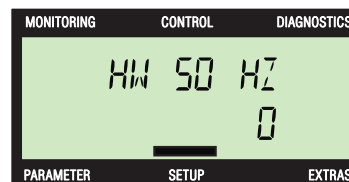

Motor voltage

The input of the voltage from the rating label of the motor must correspond with the wiring of the motor (star/delta).

1. Press **OK** to modify the parameter value..
2. Using the **▲** and **▼** keys (or digit-by-digit method) increase or decrease the displayed value.
3. Press **OK** to confirm the selected value. The display will automatically display the next parameter in the commissioning sequence.

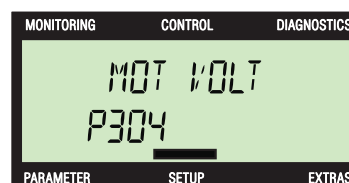

Motor current

Sets the value of the motor current in ampere taken from the motor rating plate.

1. Press **OK** to modify the parameter value.
2. Using the **▲** and **▼** keys (or digit-by-digit method) increase or decrease the displayed value.
3. Press **OK** to confirm the selected value. The display will automatically display the next parameter in the commissioning sequence.



Motor power

Sets the value of the motor power in kW or hp taken from the motor rating plate.

1. Press **OK** to modify the parameter value.
2. Using the **▲** and **▼** keys (or digit-by-digit method) increase or decrease the displayed value.
3. Press **OK** to confirm the selected value. The display will automatically display the next parameter in the commissioning sequence.

If P0100 = 0 or 2, data is in kW and if P0100 = 1, the data is in hp.

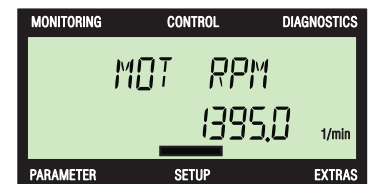
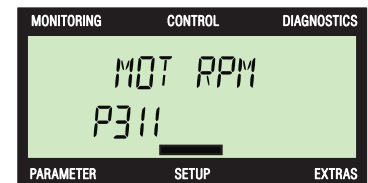
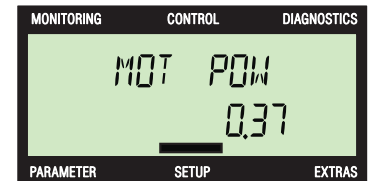
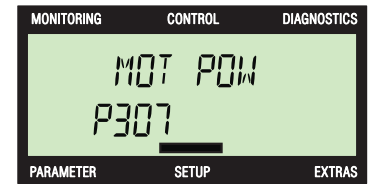

Motor speed

Sets the value of the motor speed in RPM taken from the motor rating plate.

1. Press **OK** to modify the parameter value.
2. Using the **▲** and **▼** keys (or digit-by-digit method) increase or decrease the displayed value.
3. Press **OK** to confirm the selected value. The display will automatically display the next parameter in the commissioning sequence.

Motor identification

Sets the motor data identification and speed controller optimization.

1. Press **OK** to modify the parameter value.
2. Using the **▲** and **▼** keys to scroll through the various options until the required setting is visible.
3. Press **OK** to confirm the selected value. The display will automatically display the next parameter in the commissioning sequence.

Motor identification will not start until the basic commissioning sequence has been completed.

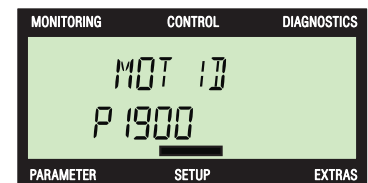

Command source

Sets the command source for the Inverter. For Inverters without fieldbus communications, the command source default is the Terminals (2) or with fieldbus communications then the default setting is the Fieldbus (6).

1. Press **OK** to modify the parameter value.
2. Using the **▲** and **▼** keys to scroll through the various options until the required setting is visible.
3. Press **OK** to confirm the selected value. The display will automatically display the next parameter in the commissioning sequence.



Main setpoint

Sets the setpoint source for the Inverter. For Inverters without fieldbus communications, the command source default is Analog (2) or with fieldbus communications then the default setting is the Fieldbus (6).

1. Press **OK** to modify the parameter value.
2. Using the **▲** and **▼** keys to scroll through the various options until the required setting is visible.
3. Press **OK** to confirm the selected value. The display will automatically display the next parameter in the commissioning sequence.

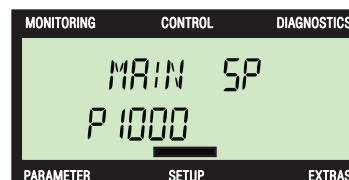

Additional setpoint

Sets the second setpoint source for the Inverter. The default value for this setting is 0, that is, there is no secondary setpoint source.

1. Press **OK** to modify the parameter value.
2. Using the **▲** and **▼** keys to scroll through the various options until the required setting is visible.
3. Press **OK** to confirm the selected value. The display will automatically display the next parameter in the commissioning sequence.

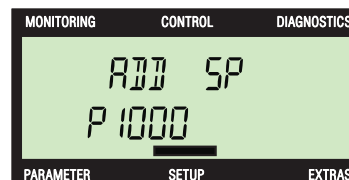

Minimum RPM

Sets the lowest speed to which the motor operates independently of the frequency setpoint.

1. Press **OK** to modify the parameter value.
2. Using the **▲** and **▼** keys (or digit-by-digit method) increase or decrease the displayed value.
3. Press **OK** to confirm the selected value. The display will automatically display the next parameter in the commissioning sequence.

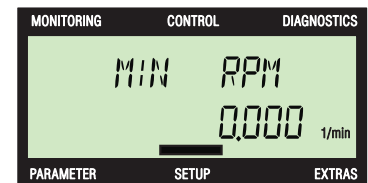
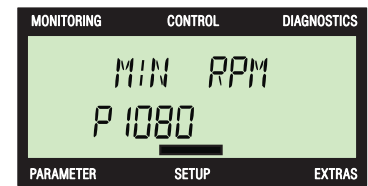

Ramp up time

Set the time, in seconds, in which the motor should accelerate from standstill up to the maximum RPM set in P1082.

1. Press **OK** to modify the parameter value.
2. Using the **▲** and **▼** keys (or digit-by-digit method) increase or decrease the displayed value.
3. Press **OK** to confirm the selected value. The display will automatically display the next parameter in the commissioning sequence.

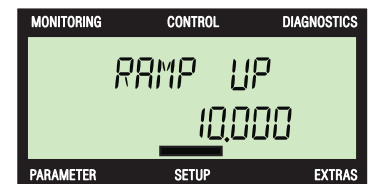
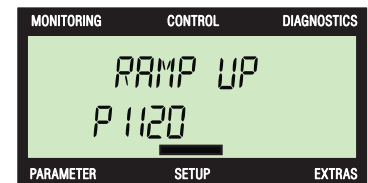

Ramp down time

Set the time, in seconds, in which the motor should decelerate from maximum RPM (P1082) down to a standstill.

1. Press **OK** to modify the parameter value.
2. Using the **▲** and **▼** keys (or digit-by-digit method) increase or decrease the displayed value.
3. Press **OK** to confirm the selected value. The display will automatically display the next parameter in the commissioning sequence.

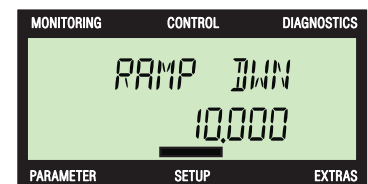
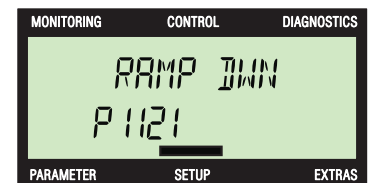

Finish

Confirms the end of the commissioning process. The Inverter will perform a motor calculation change all the relevant parameters within the Control Module

1. Press **OK** to modify the parameter value.
2. Using the **▲** and **▼** keys to select Yes or No.
3. Press **OK** to confirm the selection and complete the commissioning process.



Busy

The display during the process of changing the parameter information of the Inverter will display "BUSY".



Done

When the commissioning process is completed, the BOP-2 will display "DONE". If a problem has occurred or there has been an interruption to the final process then the BOP-2 will display "FAILURE". Should this happen, the Inverter is to be considered unstable and the reason for the failure should be investigated and the commissioning process restarted.



Extras

9

Extras menu

The extras menu allows the user to perform the following functions:

- DRVRESET - reset the Inverter to the factory default settings.
- RAM → ROM - copies data from the Inverters RAM to the Inverters ROM.
- FROM CRD - reads parameter data from the memory card into the Inverter memory.
- TO CARD - writes parameter data from the Inverter memory on to the memory card.
- FROM BOP - reads parameter data from the BOP-2 to the Inverter memory.
- TO BOP - writes parameter data from the Inverter memory to the BOP-2.

The basic steps for these functions are shown below.

Extras menu

1. Using the ▲ and ▼ keys navigate to the Extras menu.
2. Press OK to display the first option of the Extras menu.



Drive reset

Resets the Inverter to the factory default settings.

1. Press OK to select the DRVRESET function.
2. Using the ▲ and ▼ keys select "Yes" to reset the Inverter to its default settings.
3. Press OK to confirm selection.
4. The Inverter will perform a factory reset and the BOP-2 will display "BUSY" during this process.
5. On completion of the factory reset the BOP-2 will display "DONE".
6. Press ESC or OK to return to the "EXTRAS" top-level menu.



RAM → ROM

The RAM → ROM function allows the data stored on the Inverters RAM to be saved to the Inverters ROM. The data is stored permanently in the ROM until it is overwritten by another RAM to ROM command.

1. Using the ▲ and ▼ keys select the "RAM → ROM" function.
2. Press **OK** to confirm selection.
3. Press **OK** to active the data transfer.
4. Press **ESC** to cancel the data transfer.
5. During the transfer of data "BUSY" will be displayed.
6. When the transfer is complete "DONE" will be displayed.
7. Press **ESC** or **OK** to return to the "EXTRAS" top-level menu.

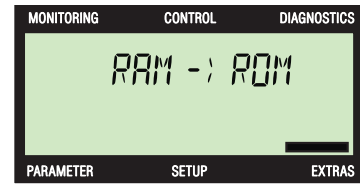

To BOP

Writes parameter data from the Inverter memory to the BOP-2.

1. Using the ▲ and ▼ keys select the "TO BOP" function.
2. Press **OK** to active the data transfer.
3. The confirmation screen will be displayed.
4. Press **OK** to active the data transfer.
5. Press **ESC** to cancel the data transfer.
6. The BOP-2 will start saving parameters.
7. The BOP-2 will create a zip file of all the parameter data to be copied.
8. The cloning process will be started and the BOP-2 will display the cloning information screen.
9. On completion of the cloning process the screen will display "-Done-".
10. Press **OK** to return to the "TO BOP" screen.
11. Press **ESC** or **OK** to return to the "EXTRAS" top-level menu.

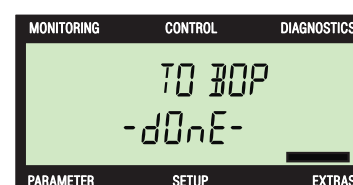
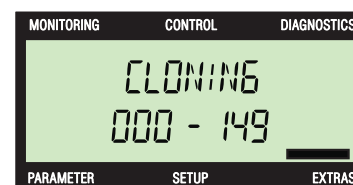
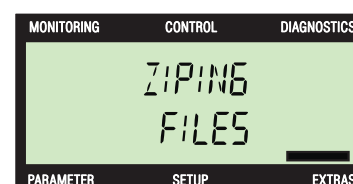

From BOP

Writes parameter data from the BOP-2 to the Inverter memory.

1. Using the ▲ and ▼ keys select the "FROM BOP" function.
2. Press **OK** to active the data transfer.
3. The confirmation screen will be displayed.
4. Press **OK** to active the data transfer.
5. Press **ESC** to cancel the data transfer.
6. The cloning process will be started and the BOP-2 will display the cloning information screen.
7. The BOP-2 will unzip the data files.
8. On completion of the cloning process the screen will display "-Done-".
9. Press **ESC** or **OK** to return to the "EXTRAS" top-level menu.

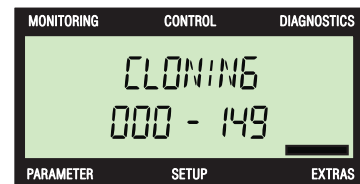

To card

Writes parameter data from the Inverter memory on to the memory card.

1. Using the ▲ and ▼ keys select the "TO CRD" function.
2. Press **OK** to select the data transfer option.
3. The parameter set screen will be displayed.
4. Use the ▲ and ▼ keys to change the required parameter set value. The default is parameter set 0.
5. Press **OK** to activate the data transfer.
6. The confirmation screen will be displayed.
7. Press **OK** to activate the data transfer.
8. Press **ESC** to cancel the data transfer.
9. The cloning screen will be displayed briefly.
10. On completion of the cloning process the screen will display "-Done-".
11. Press **ESC** or **OK** to return to the "EXTRAS" top-level menu.

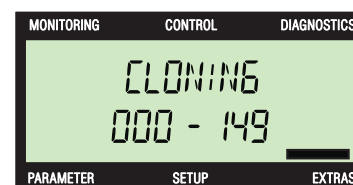

From card

Reads parameter data from the memory card into the Inverter memory.

1. Using the ▲ and ▼ keys select the "FROM CRD" function.
2. Press **OK** to select the data transfer option.
3. The parameter set screen will be displayed.
4. Use the ▲ and ▼ keys to change the required parameter set value. The default is parameter set 0.
5. Press **OK** to active the data transfer.
6. The confirmation screen will be displayed.
7. Press **OK** to active the data transfer.
8. Press **ESC** to cancel the data transfer.
9. The cloning screen will be displayed briefly.
10. On completion of the cloning process the screen will display "-Done-".
11. Press **ESC** or **OK** to return to the "EXTRAS" top-level menu.

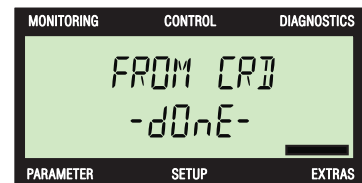
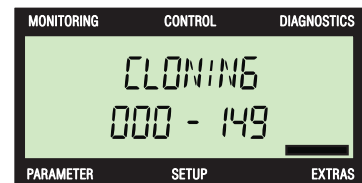
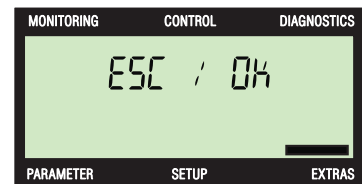
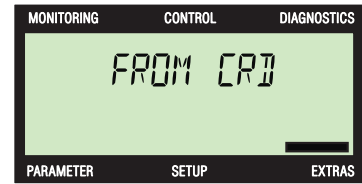

Technical data

BOP-2 specifications

Table 10- 1 BOP-2 specifications

Feature	Description
Protection	Depending upon the Control Unit IP rating to a max. of IP55
Dimensions (H x W x D)	106.86 mm x 70 mm x 19.6 mm
Net weight	0.10 Kg (0.22 lbs)
Gross weight	0.17 Kg (0.37 lbs)
Operating ambient temperature	0 - 50 °C (32 - 122 °F) under nominal conditions of the attached inverter.
Transport and storage ambient temperature	-40 - +70 °C (-40 - 158 °F)
Humidity	Maximum absolute humidity 25 g/m ³

Siemens AG
Industry Sector
Postfach 48 48
90026 NÜRNBERG
DEUTSCHLAND

Änderungen vorbehalten
© Siemens AG 2009

<http://support.automation.siemens.com>