

Proximity sensors SMT/SME-8, for T-slot

FESTO

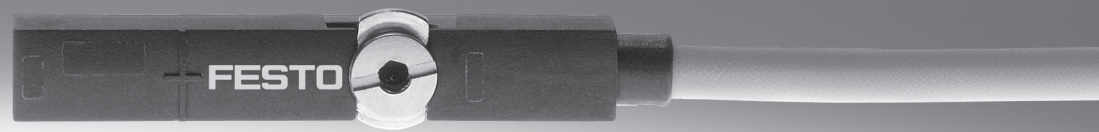

Proximity sensors SMT/SME

Product range overview



Design	Type of mounting	Measuring principle	Type	Operating voltage range	Switching output	Switching element function	→ Page/ Internet
For T-slot	Standard						
	Insertable in slot from above, flush with cylinder profile	Magneto-resistive	SMT-8M	10 ... 30 V DC	PNP	N/O contact	9
					NPN	N/C contact	
		Magnetic reed	SME-8M	5 ... 30 V AC/DC	Contacting, bipolar	N/O contact	
						N/C contact	
	Insertable in slot length-wise, flush with cylinder profile	Magneto-resistive	SMT-8	10 ... 30 V DC	PNP	N/O contact	21
					NPN		
	Insertable in slot length-wise, flush with cylinder profile	Magnetic reed	SME-8	12 ... 30 V AC/DC	Contacting, bipolar	N/O contact	25
				3 ... 230 V AC/DC		N/C contact	
				5 ... 250 V AC/DC		N/O contact	28
	Insertable in slot length-wise	Magneto-resistive	SMT-8G	10 ... 30 V DC	PNP	N/O contact	31
		Inductive	SMT-8-SL	10 ... 30 V DC	PNP	N/O contact	21
		Magnetic reed	SME-8-SL	10 ... 30 V AC/DC	Contacting, bipolar	N/O contact	25
	Insertable in slot from above	Magnetic reed	SME-8-FM	10 ... 30 V AC/DC	Contacting, bipolar	N/O contact	35
	Via accessories	Magneto-resistive	SMT0-8E	10 ... 30 V DC	PNP	N/O contact	38
					NPN		
		Magnetic reed	SME0-8E	12 ... 30 V DC	Contacting, bipolar	N/O contact	39
	3 ... 250 V DC	40					
	3 ... 230 V AC						
	Corrosion resistant						
	Insertable in slot length-wise, flush with cylinder profile	Magneto-resistive	CRSMT-8	10 ... 30 V DC	PNP	N/O contact	21
	Welding field immune						
	Via accessories	Magneto-inductive	SMTSO-8E	10 ... 30 V DC	PNP	N/O contact	38
				NPN			
Heat resistant up to 120 °C							
Insertable in slot length-wise, flush with cylinder profile	Magnetic reed	SME-8-...-S6	0 ... 30 V AC/DC	Contacting, bipolar	N/O contact	28	
Via accessories	Magnetic reed	SME0-8E-...-S6	0 ... 30 V DC	Contacting	N/O contact	40	
			0 ... 30 V AC				

Proximity sensors SMT/SME

Product range overview

Design	Type of mounting	Measuring principle	Type	Operating voltage range	Switching output	Switching element function	→ Page/ Internet
For C-slot	Standard						
	Insertable in slot from above, flush with cylinder profile	Magneto-resistive	SMT-10F	5 ... 30 V DC	PNP	N/O contact	c-slot
				10 ... 30 V DC	NPN		
		Magnetic reed	SME-10F	10 ... 30 V AC/DC	Non-contacting, 2-wire	N/O contact	
				5 ... 30 V AC/DC	Contacting, bipolar		
	Insertable in slot length-wise	Magneto-resistive	SMT-10G	10 ... 30 V DC	PNP	N/O contact	
		Magneto-resistive	SMT-10	10 ... 30 V DC	PNP	N/O contact	
					NPN		
Magnetic reed		SME-10	12 ... 27 V AC/DC	Contacting	N/O contact		

Proximity sensors SMT/SME

Selection aid

FESTO

Drive		SMT-8, SMT0-8E CRSMT-8 SME-8, SME0-8E SMPO-8E	SMT-10 SME-10	SMT0-4U SME0-4U CRSME0-4	SMT0-1 SMT0-6 SME0-1 SMPO-1	SMT-C1
Standards-based cylinders						
Standard cylinders DSNU, ESNU	∅ 8 ... 25 mm	■	■	■	■	-
Standard cylinders DSN, ESN	∅ 8 ... 25 mm	■	■	■	■	-
Standard cylinders DNCB		■	-	-	-	-
Standard cylinders DNC		■	-	-	-	-
Standard cylinders DNG		■	-	-	■	-
Standard cylinders CDN-...-R with sensor rail		-	-	-	-	■
Standard cylinders ADN		■	-	-	-	-
Cylinders with piston rod						
Compact cylinders ADVU, AEVU		■	-	-	-	-
Short-stroke cylinders ADVC, AEVC	∅ 6 ... 25 mm	-	■	-	-	-
	∅ 32 ... 100 mm	■	-	-	-	-
Flat cylinders EZH-10/40-40-A-B		■	-	-	-	-
Flat cylinders DZF		■	-	-	-	-
Flat cylinders DZH	∅ 16 ... 25 mm	■	-	-	-	-
	∅ 32 ... 63 mm	-	-	-	■	-
Round cylinders DSNU, ESNU	∅ 32 ... 63 mm	■	■	■	■	-
Round cylinders DSW, ESW		■	■	■	■	-
Round cylinders DSEU, ESEU		■	■	■	■	-
Multimount cylinders DMM, EMM		■	-	-	-	-
Round cylinders CRDG		-	-	■	-	-
Round cylinders CRDSW		■	■	■	■	-
Standard cylinders CRHD		■	-	-	-	-
Standard cylinders CRDSNU		■	-	■	-	-
Standard cylinders CRDNG		■	-	■	-	-
Standard cylinders CRDNCS		■	-	■	-	-
Rodless cylinders						
Linear drives DGC	∅ 8, 12 mm	-	■	-	-	-
	∅ 18 ... 63 mm	■	-	-	-	-
Linear drives DGP, DGPL		■	-	-	-	-
Linear drives SLG		-	■	-	-	-
Linear drives DGO		-	-	■	-	-
Linear drives SLM		■	-	-	-	-
Semi-rotary drives						
Swivel modules DSM	∅ 6 ... 10 mm	-	■	-	-	-
Swivel modules DSM-B	∅ 12 ... 40 mm	-	■	-	-	-
	∅ 63 mm	■	-	-	-	-
Semi-rotary drives DRQ	∅ 16 ... 32 mm	■	-	-	-	-
	∅ 40 ... 100 mm	-	-	-	■	-
Semi-rotary drives DRQD	∅ 6 ... 12 mm	-	■	-	-	-
	∅ 16 ... 32 mm	■	-	-	-	-
Technical data → Page/Internet		9	c-slot	smt0, crsmeo	smt0	smt-c1

Proximity sensors SMT/SME

Selection aid

Drive	SMT-8, SMT0-8E CRSMT-8 SME-8, SME0-8E, SMPO-8E	SMT-10 SME-10	SMH-S1
Function-oriented drives			
Stopper cylinders STA, STAF	■	-	-
Linear/swivel clamps CLR	■	-	-
Swivel/linear units DSL	■	-	-
Swivel/linear units DSL-B	-	■	-
Drives with linear guide			
Mini slides SLS, SLF, SLT	-	■	-
Mini slides DGSL	-	■	-
Twin-piston cylinders SPZ	■	-	-
Slide units SLZ	■	-	-
Guided drives DFP	∅ 6 ... 16 mm	-	■
	∅ 25 ... 80 mm	■	-
Mini guide units DFC	-	■	-
Guide units DFM	■	-	-
Guide units DFM-B	■ ¹⁾	-	-
Linear drive units SLE	∅ 32 ... 50 mm	■	-
Twin-piston cylinders DPZC	-	■	-
Twin-piston cylinders DPZ	■	-	-
Handling units			
Linear modules HMP	■	-	-
Linear modules HMPL	■	-	-
Handling modules HSP, HSW	■	-	-
Feed separators HPV	■	-	-
Three-point grippers HGD	∅ 16 mm	-	■
	∅ 32, 50 mm	■ ²⁾	-
Three-point grippers HGDT	-	■	-
Parallel grippers HGP	∅ 6 mm	-	■
	∅ 10 ... 35 mm	■ ²⁾	-
Parallel grippers HGPC	-	■	-
Parallel grippers HGPP	∅ 12 ... 32 mm	-	■
Parallel grippers HGPT	∅ 16 ... 63 mm	-	■
Angle grippers HGW	∅ 10 mm	-	■
	∅ 16 ... 40 mm	■	-
Radial grippers HGR	∅ 10 mm	-	■
	∅ 16 ... 40 mm	■	-
Swivel gripper units HGDS	-	■	-
Cushioning components			
Stop elements YSRWJ	■	-	-
Electrical positioning systems			
Toothed belt axes DGE-ZR	■	-	-
Spindle axes DGE-SP	■	-	-
System components			
Heavy-duty guides HD	■	-	-
Valve actuators			
Linear actuators, Copac DLP-A	■	-	-
Technical data → Page/Internet	9	c-slot	smh

1) Not SM...0-8E.

2) SME-8M only for HGD-50, HGP-20 ... 35.

Proximity sensors SMT/SME-8, for T-slot

Peripherals overview

FESTO

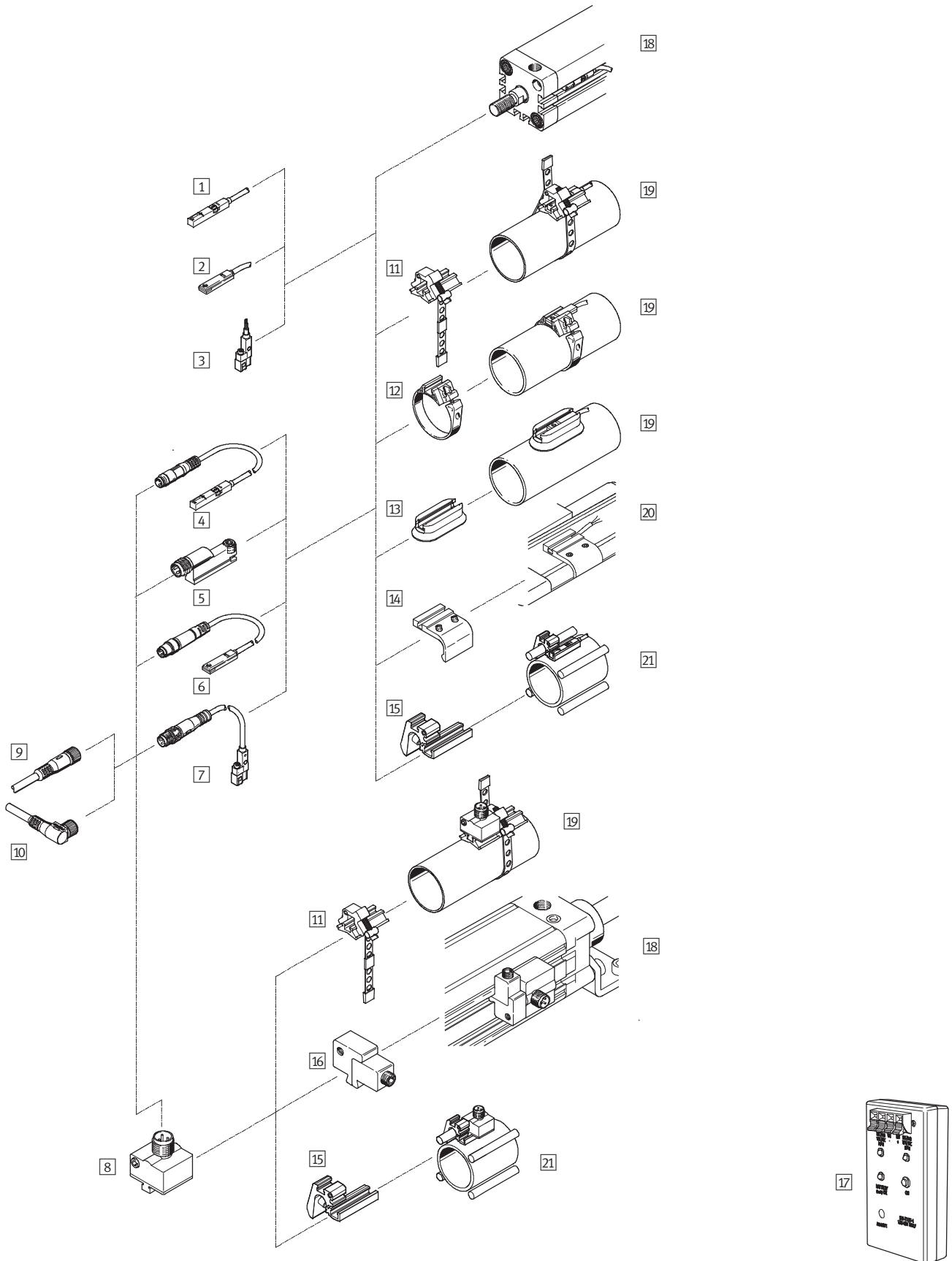

Proximity sensors SMT/SME-8, for T-slot

Peripherals overview

FESTO

Mounting attachments and accessories		→ Page/ Internet
Proximity sensors		
1	SMT/SME-8M-...-OE, with cable	9
2	SMT/SME-8-K-..., with cable	21
	SME-8-FM-...-K-..., with cable	35
	CRSMT-8-K-..., with cable, corrosion resistant	21
3	SMT-8G-...-OE, with cable	32
4	SMT/SME-8M-...-M..., with cable and plug	9
5	SMT-8-SL-..., with plug	21
	SME-8-SL-..., with plug	25
6	SMT-8-S-..., with cable and plug	21
	SME-8-S-..., with cable and plug	25
7	SMT-8G-...-M..., with cable and plug	32
8	SMT0/SMTSO/SME0-8E, with cable or plug	40
Connecting cables		
9	NEBU-M...G...	44
10	NEBU-M...W...	44

Mounting attachments and accessories		→ Page/ Internet
Mounting kits and accessories		
11	Mounting kit SMBR-8-8/100-S6, heat resistant	41
12	Mounting kit SMBR	41
13	Mounting kit CRSMB, corrosion resistant	42
13	Mounting kit SMB-8-FENG	42
15	Mounting SMBZ-8-...	43
16	Mounting kit SMB-8E	42
17	Sensor tester SM-TEST-1	44
-	Positioning component SMM-8	43
-	Clip SMBK-8	44
-	Inscription label ASLR	44
-	Safety clip NEAU	44
Drives		
18	Drives with T-slot	-
19	Round cylinders	
20	Standard cylinders DNC, DNCB, DNCKE	
21	Drives with tie or mounting rod	

Proximity sensors SMT/SME-8M, for T-slot

Type codes



SMT/SME-8M

		SMT	8M	PO	24V	K	7,5	OE
Function								
SMT	Proximity sensor, magneto-resistive							
SME	Proximity sensor, magnetic reed							
Design								
8M	For T-slot, insertable in slot from above							
Switching output, switching element function								
PS	PNP, N/O contact, 3-wire							
PO	PNP, N/C contact, 3-wire							
NS	NPN, N/O contact, 3-wire							
ZS	N/O contact, 2-wire							
DS	N/O contact, 3-wire							
DO	N/C contact, 3-wire							
Rated operating voltage								
24V	24 V DC							
Cable properties								
K	Standard + energy chain							
E	Energy chain + robot applications							
Cable length [m]								
Electrical connection								
OE	Open end							
M5D	Cable with plug M5x0.5, rotatable thread							
M8	Cable with plug M8x1, snap-on flange							
M8D	Cable with plug M8x1, rotatable thread							
M12	Cable with plug M12x1, rotatable thread							

Proximity sensors SMT-8M, for T-slot

Technical data – Magneto-resistive

Function

e.g. PNP, N/O contact, with cable

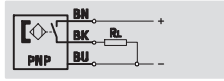

e.g. NPN, N/O contact, with cable

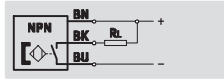

- Magneto-resistive measuring principle
- Insertable in slot from above, does not protrude over the cylinder profile
- Cable clip and inscription labels included in the scope of delivery

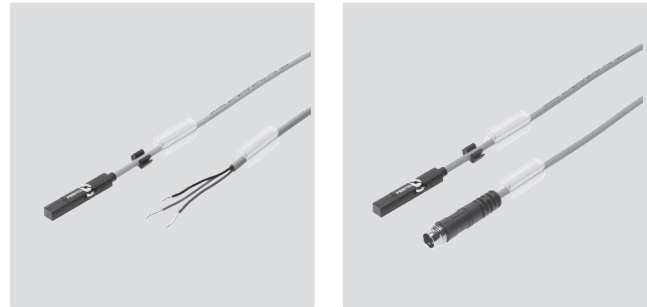

General technical data	
Design	For T-slot
Based on standard	EN 60947-5-2
Certification	cULus listed (OL) C-Tick
CE mark (see declaration of conformity)	To EU EMC Directive
Note on materials	Free of copper and PTFE RoHS-compliant

Input signal/measuring element	
Measuring principle	Magneto-resistive
Ambient temperature [°C]	-20 ... +70

Switching output			
Type	SMT-8M-PS	SMT-8M-NS	SMT-8M-PO
Switching output	PNP	NPN	PNP
Switching element function	N/O contact		N/C contact
Max. output current [mA]	100		
Max. switching capacity DC [W]	3		

Output, additional data	
Protection against short circuit	Pulsed
Protection against overloading	Yes

Electronic components	
Operating voltage range [V DC]	10 ... 30
Reverse polarity protection	For all electrical connections

Proximity sensors SMT-8M, for T-slot

Technical data – Magneto-resistive

FESTO

Electromechanical components					
Electrical connection	OE	M5D	M8D	M8	M12
Electrical connection	Cable, 3-wire	Cable with plug, 3-pin			
		M5x0.5	M8x1	M8x1	M12x1
		Rotatable thread	Rotatable thread	Snap-on flange	Rotatable thread
Connection direction	In-line				
Cable test conditions	K	Energy chain: 5 million cycles, bending radius 75 mm			
		Resistance to bending: to Festo standard; test conditions on request			
	E	Energy chain: 5 million cycles, bending radius 28 mm			
		Torsional strength: $\pm 270^\circ/0.1$ m			
		Resistance to bending: to Festo standard; test conditions on request			
Cable length	[m]	0.2 ... 30			
Cable properties	K	Standard + energy chain			
	E	Energy chain + robot applications			
Cable sheath material	K	TPE-U(PU), oil resistant			
	E	TPE-U(PU), oil resistant, halogen free			

Mechanical components		
Electrical connection	OE	M...
Type of mounting	Screw-clamped in slot, insertable from above	
Housing	PA	PA
	High-alloy stainless steel	High-alloy stainless steel
	–	Nickel-plated brass
	–	TPE-U(PU)

Display/operation	
Switching status display	Yellow LED

Immissions/emissions		
Ambient temperature with flexible cable installation	[°C]	–5 ... +70
Protection class	IP65, IP68	

Pin allocation			
M5x0.5, 3-pin			
N/O contact			
	Pin	Wire colour	Allocation
	1	Brown	+
	3	Blue	–
	4	Black	Output

Pin allocation to EN 60947-5-2			
M8x1, 3-pin			
N/O contact and N/C contact			
	Pin	Wire colour	Allocation
	1	Brown	+
	3	Blue	–
	4	Black	Output

Pin allocation to EN 60947-5-2			
M12x1, 3-pin			
N/O contact			
	Pin	Wire colour	Allocation
	1	Brown	+
	3	Blue	–
	4	Black	Output

Pin allocation to EN 60947-5-2			
M12x1, 3-pin			
N/C contact			
	Pin	Wire colour	Allocation
	1	Brown	+
	3	Blue	–
	2	White	Output

Proximity sensors SMT-8M, for T-slot

Technical data – Magneto-resistive



Dimensions

Download CAD data → www.festo.com

SMT-8M-...-OE – Cable

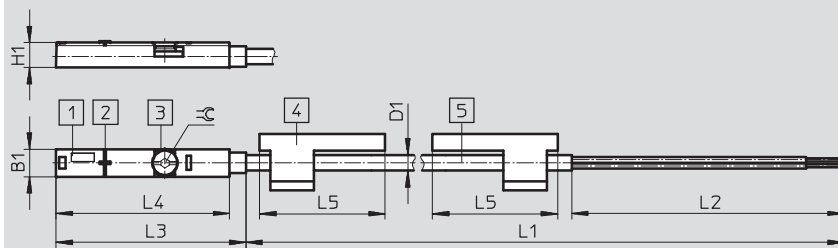

- 1 Yellow LED
- 2 Centre of the sensor element
- 3 Clamping component, tightening torque 0.6 Nm
- 4 Inscription label holder
- 5 Connecting cable

L1 Cable length

SMT-8M-...-M5D – Cable with plug M5x0.5, rotatable thread

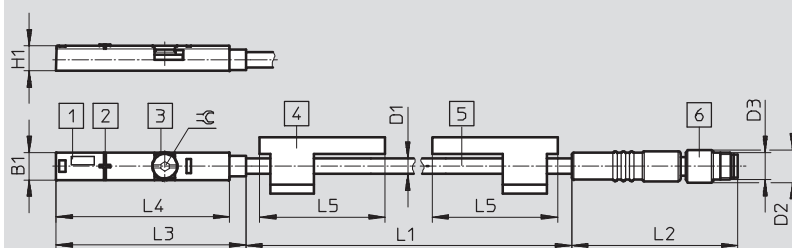

- 1 Yellow LED
- 2 Centre of the sensor element
- 3 Clamping component, tightening torque 0.6 Nm
- 4 Inscription label holder
- 5 Connecting cable
- 6 Plug to fit connecting cable NEBU-M5

L1 Cable length

SMT-8M-...-M8D – Cable with plug M8x1, rotatable thread

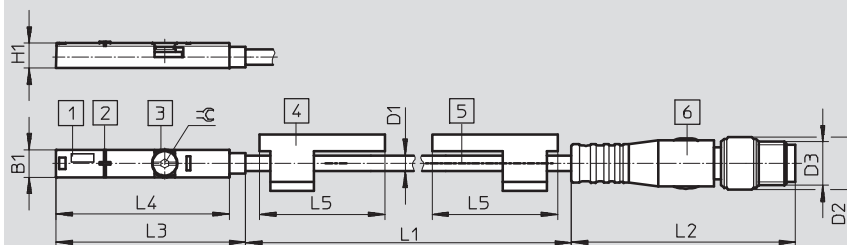

- 1 Yellow LED
- 2 Centre of the sensor element
- 3 Clamping component, tightening torque 0.6 Nm
- 4 Inscription label holder
- 5 Connecting cable
- 6 Plug to fit connecting cable NEBU-M8

L1 Cable length

SMT-8M-...-M8 – Cable with plug M8x1, snap-on flange

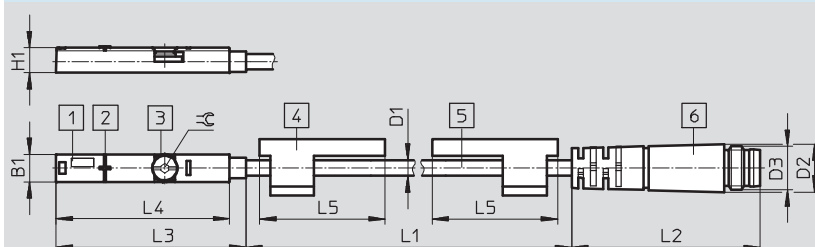

- 1 Yellow LED
- 2 Centre of the sensor element
- 3 Clamping component, tightening torque 0.6 Nm
- 4 Inscription label holder
- 5 Connecting cable
- 6 Plug to fit connecting cable NEBU-M8

L1 Cable length

Type	B1	D1	D2	D3	H1	L2	L3	L4	L5	∅C
SMT-8M-...-OE	5	2.9	-	-	4.6	50	34.8	31.8	23	1.5
SMT-8M-...-M5D			6	M5x0.5		30.5				
SMT-8M-...-M8D			9.6	M8x1		41				
SMT-8M-...-M8			8.8	M8x1		35				

Proximity sensors SMT-8M, for T-slot

Technical data – Magneto-resistive



Dimensions Download CAD data → www.festo.com

SMT-8M-...-M12 – Cable with plug M12x1, rotatable thread

- 1 Yellow LED
- 2 Centre of the sensor element
- 3 Clamping component, tightening torque 0.6 Nm
- 4 Inscription label holder
- 5 Connecting cable
- 6 Plug to fit connecting cable NEBU-M12

L1 Cable length

Type	B1	D1	D2	D3	H1	L2	L3	L4	L5	⌀
SMT-8M-...-M12	5	2.9	15	M12x1	4.6	55.5	34.8	31.8	23	1.5

Ordering data		Switching output	Electrical connection			Cable length [m]	Part No.	Type
			Cable	Cable with plug, rotatable thread				
				M5x0.5	M8x1	M12x1		
	N/O contact							
	PNP	3-wire	–	–	–	2.5	543867	SMT-8M-PS-24V-K-2,5-OE
			–	–	–	5.0	543868	SMT-8M-PS-24V-K-5,0-OE
		–	3-pin	–	–	0.3	543865	SMT-8M-PS-24V-K-0,3-M5D
			–	–	3-pin	–	543866	SMT-8M-PS-24V-K-0,3-M8D
	NPN	3-wire	–	–	–	2.5	543870	SMT-8M-NS-24V-K-2,5-OE
			–	–	3-pin	–	543871	SMT-8M-NS-24V-K-0,3-M8D
–		–	–	–	–	–	–	
N/C contact								
	PNP	3-wire	–	–	–	7.5	543873	SMT-8M-PO-24V-K-7,5-OE

Proximity sensors SMT-8M, for T-slot

Modular products – Magneto-resistive

M Mandatory data						
Module No.	Function	Switching output	Rated operating voltage	Cable properties	Cable length	Connection technology
543893	SMT-8M	PS NS PO	24V	K E	0.2 ... 30	OE M8D M8 M12
Ordering example						
543893	SMT-8M	- NS	- 24V	- E	- 3	- M8D

Ordering table				
Size	8	Condi-tions	Code	Enter code
M Module No.	543893			
Function	Proximity sensor for T-slot, non-contacting		SMT-8M	SMT-8M
			-	-
Switching output	3-wire PNP N/O contact		PS	
	3-wire NPN N/O contact		NS	
	3-wire PNP N/C contact		PO	
			-	-
Rated operating voltage [V DC]	24		24V	24V
			-	-
Cable properties	Standard + energy chain		K	
	Energy chain + robot applications		E	
			-	-
Cable length [m]	0.2 ... 30		...	
	(0.2 ... 5.0 m in 0.1 m steps, 5.0 ... 30 m in 0.5 m steps)			
			-	-
Connection technology	Open end		OE	
	M8, rotatable thread		M8D	
	M8, snap-on flange		M8	
	M12, rotatable thread		M12	

Transfer order code

543893 SMT-8M - [] - 24V - [] - [] - []

Proximity sensors SME-8M, for T-slot

Technical data – Magnetic reed

Function

e.g. N/O contact, 3-wire, with cable

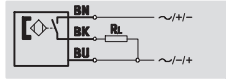

e.g. N/O contact, 3-wire, with plug

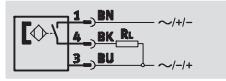

- Magnetic reed measuring principle
- Insertable in slot from above, does not protrude over the cylinder profile
- Cable clip and inscription labels included in the scope of delivery

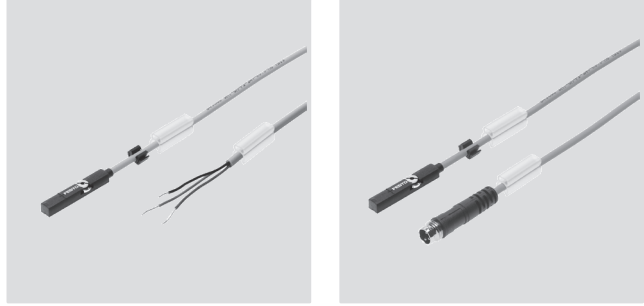

General technical data	
Design	For T-slot
Based on standard	EN 60947-5-2
Certification	cULus listed (OL)
	C-Tick
CE mark (see declaration of conformity)	To EU EMC Directive
Note on materials	Free of copper and PTFE
	RoHS-compliant

Input signal/measuring element	
Measuring principle	Magnetic reed
Ambient temperature	[°C] -40 ... +70

Switching output				
Type		SME-8M-DS	SME-8M-ZS	SME-8M-DO
Switching output		Contacting, bipolar		
Switching element function		N/O contact	N/O contact	N/C contact
Max. output current	[mA]	500	80	
Max. output current in mounting kits	[mA]	80	80	
Max. switching capacity DC	[W]	10	2.4	
Max. switching capacity DC in mounting kits	[W]	2.4	2.4	
Max. switching capacity AC	[VA]	10	2.4	
Max. switching capacity AC in mounting kits	[VA]	2.4	2.4	
Voltage drop ¹⁾	[V]	1.5	4.8	3.5

1) Applies to cable length 2.5 m. Max. 0.15 V voltage drop per metre of additional cable length

Output, additional data	
Protection against short circuit	No
Protection against overloading	No

Electronic components	
Operating voltage range DC	[V] 5 ... 30
Operating voltage range AC	[V] 5 ... 30
Reverse polarity protection	No

Proximity sensors SME-8M, for T-slot

Technical data – Magnetic reed

Electromechanical components										
Switching element function		DS/DO					ZS			
Electrical connection		OE	M5D	M8D	M8	M12	OE	M8D	M8	M12
Electrical connection		Cable, 3-wire	Cable with plug, 3-pin				Cable, 2-wire	Cable with plug, 2-pin		
			M5x0.5	M8x1	M8x1	M12x1		M8x1	M8x1	M12x1
			Rotatable thread	Rotatable thread	Snap-on flange	Rotatable thread	Rotatable thread	Snap-on flange	Rotatable thread	
Connection direction		In-line								
Cable test conditions		K	Energy chain: 5 million cycles, bending radius 75 mm							
			Resistance to bending: to Festo standard; test conditions on request							
		E	Energy chain: 5 million cycles, bending radius 28 mm							
			Torsional strength: ±270°/0.1 m							
		Resistance to bending: to Festo standard; test conditions on request								
Cable length	[m]	0.2 ... 10								
Cable properties		K	Standard + energy chain							
		E	Energy chain + robot applications							
Cable sheath material		K	TPE-U(PU), oil resistant							
		E	TPE-U(PU), oil resistant, halogen free							

Mechanical components		
Electrical connection	OE	M...
Type of mounting	Screw-clamped in slot, insertable from above	
Housing	PA	PA
	High-alloy stainless steel	High-alloy stainless steel
	–	Nickel-plated brass
	–	TPE-U(PU)

Display/operation	
Switching status display	Yellow LED

Immissions/emissions		
Ambient temperature with flexible cable installation	[°C]	–5 ... +70
Protection class	IP65, IP68	

Pin allocation			
M5x0.5, 3-pin			
N/O contact			
	Pin	Wire colour	Allocation
	1	Brown	+
	3	Blue	–
	4	Black	Output

Pin allocation to EN 60947-5-2			
M8x1, 3-pin			
N/O contact and N/C contact			
	Pin	Wire colour	Allocation
	1	Brown	+
	3	Blue	–
	4	Black	Output

Pin allocation to EN 60947-5-2			
M12x1, 3-pin			
N/O contact		N/C contact	
	Pin	Wire colour	Allocation
	1	Brown	+
	3	Blue	–
	4	Black	Output
	Pin	Wire colour	Allocation
	1	Brown	+
	3	Blue	–
	2	White	Output

Proximity sensors SME-8M, for T-slot

Technical data – Magnetic reed



Pin allocation to EN 60947-5-2			
M8x1, 2-pin			
N/O contact			
	Pin	Wire colour	Allocation
	1	Brown	+
	4	Black	Output

Pin allocation to EN 60947-5-2			
M12x1, 2-pin			
N/O contact			
	Pin	Wire colour	Allocation
	1	Brown	+
	4	Black	Output

Dimensions Download CAD data → www.festo.com

SME-8M-...-OE – Cable

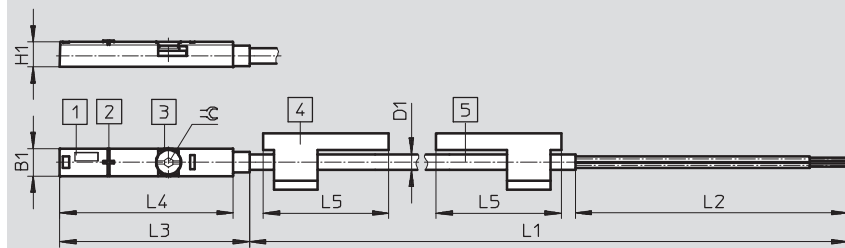

- 1 Yellow LED
- 2 Centre of the sensor element
- 3 Clamping component, tightening torque 0.6 Nm
- 4 Inscription label holder
- 5 Connecting cable

L1 Cable length

SME-8M-...-M5D – Cable with plug M5x0.5, rotatable thread

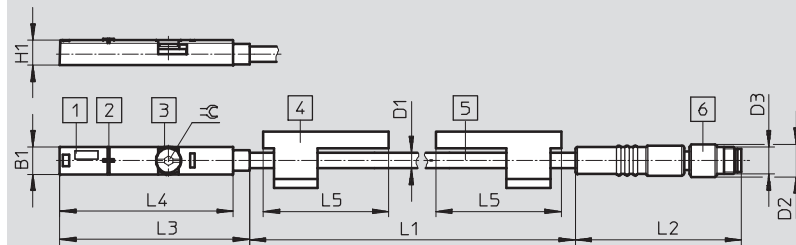

- 1 Yellow LED
- 2 Centre of the sensor element
- 3 Clamping component, tightening torque 0.6 Nm
- 4 Inscription label holder
- 5 Connecting cable
- 6 Plug to fit connecting cable NEBU-M5

L1 Cable length

SME-8M-...-M8D – Cable with plug M8x1, rotatable thread

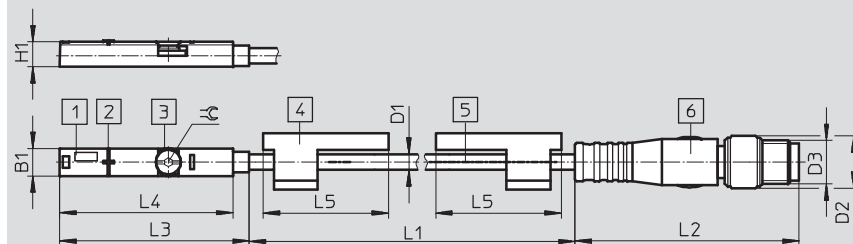

- 1 Yellow LED
- 2 Centre of the sensor element
- 3 Clamping component, tightening torque 0.6 Nm
- 4 Inscription label holder
- 5 Connecting cable
- 6 Plug to fit connecting cable NEBU-M8

L1 Cable length

Type	B1	D1	D2	D3	H1	L2	L3	L4	L5	⌀C
SME-8M-...-OE			–	–		50				
SME-8M-...-M5D	5	2.9	6	M5x0.5	4.6	30.5	34.8	31.8	23	1.5
SME-8M-...-M8D			9.6	M8x1		41				

Proximity sensors SME-8M, for T-slot

Technical data – Magnetic reed



Dimensions

Download CAD data → www.festo.com

SME-8M-...-M8 – Cable with plug M8x1, snap-on flange

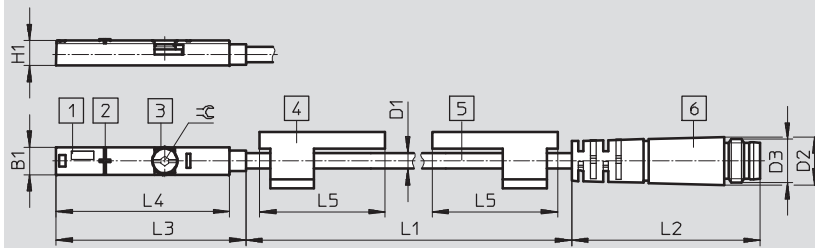

- 1 Yellow LED
- 2 Centre of the sensor element
- 3 Clamping component, tightening torque 0.6 Nm
- 4 Inscription label holder
- 5 Connecting cable
- 6 Plug to fit connecting cable NEBU-M8

L1 Cable length

SME-8M-...-M12 – Cable with plug M12x1, rotatable thread

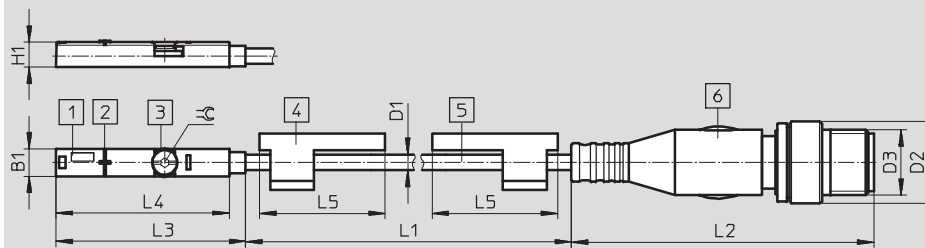

- 1 Yellow LED
- 2 Centre of the sensor element
- 3 Clamping component, tightening torque 0.6 Nm
- 4 Inscription label holder
- 5 Connecting cable
- 6 Plug to fit connecting cable NEBU-M12

L1 Cable length

Type	B1	D1	D2	D3	H1	L2	L3	L4	L5	⌀
SME-8M-...-M8	5	2.9	8.8	M8x1	4.6	35	34.8	31.8	23	1.5
SME-8M-...-M12			15	M12x1		55.5				

Ordering data

	Switching output	Electrical connection			Cable length [m]	Part No.	Type
		Cable	Cable with plug, rotatable thread				
			M5x0.5	M8x1			
	N/O contact						
	Contacting, bipolar	3-wire	–	–	2.5	543862	SME-8M-DS-24V-K-2,5-OE
			–	–	5.0	543863	SME-8M-DS-24V-K-5,0-OE
			–	–	7.5	543876	SME-8M-DS-24V-K-7,5-OE
		–	3-pin	–	0.3	543864	SME-8M-DS-24V-K-0,3-M5D
		–	–	3-pin	–	543861	SME-8M-DS-24V-K-0,3-M8D
		2-wire	–	–	2.5	543872	SME-8M-ZS-24V-K-2,5-OE
N/C contact							
Contacting, bipolar	3-wire	–	–	7.5	546799	SME-8M-DO-24V-K-7,5-OE	

Proximity sensors SME-8M, for T-slot



Modular products – Magnetic reed

M Mandatory data						
Module No.	Function	Switching output	Rated operating voltage	Cable properties	Cable length	Connection technology
543892	SME-8M	DS ZS DO	24V	K E	0.2 ... 10	OE M8D M8 M12
Ordering example						
543892	SME-8M	- ZS	- 24V	- K	- 0.8	- OE

Ordering table							
Size	8	Condi-tions		Code		Enter code	
M Module No.	543892						
Function	Proximity sensor for T-slot, contacting			SME-8M		SME-8M	
				-		-	
Switching output	3-wire N/O contact			DS			
	2-wire N/O contact			ZS			
	3-wire N/C contact			DO			
				-		-	
Rated operating voltage [V DC]	24			24V		24V	
				-		-	
Cable properties	Standard + energy chain			K			
	Energy chain + robot applications			E			
				-		-	
Cable length [m]	0.2 ... 10			...			
	(0.2 ... 5.0 m in 0.1 m steps, 5.0 ... 10 m in 0.5 m steps)						
				-		-	
Connection technology	Open end			OE			
	M8, rotatable thread			M8D			
	M8, snap-on flange			M8			
	M12, rotatable thread			M12			

Transfer order code

543892	SME-8M	-		-	24V	-		-		-	
--------	--------	---	--	---	-----	---	--	---	--	---	--

Proximity sensors SMT/CRSMT/SME-8, for T-slot

Type codes

SMT/SME-8		SMT	8	PS	K	LED	24		B	
Function		SMT	Proximity sensor, magneto-resistive							
		SME	Proximity sensor, magnetic reed							
Design		8	For T-slot, insertable in slot lengthwise							
Switching output, switching element function		PS	PNP, N/O contact, 3-wire							
		NS	NPN, N/O contact, 3-wire							
		ZS	N/O contact, 2-wire							
		O	N/C contact, 3-wire							
Electrical connection, cable length		K	Cable, 2.5 m or 7.5 m							
		K2,5	Cable, 2.5 m							
		K5	Cable, 5.0 m							
		K-7,5	Cable, 7.5 m							
		KL	Cable, 2.5 m							
		S	Plug M8x1 with cable, 0.3 m							
Switching status display		LED	Yellow LED							
Rated operating voltage		24	24 V DC							
		230	230 V AC							
Variant		S6	Heat resistant							
Generation		B	B series							

SMT/SME-8-SL		SMT	8	SL	PS	LED	24	
Function		SMT	Proximity sensor, magneto-resistive					
		SME	Proximity sensor, magnetic reed					
Design		8	For T-slot, insertable in slot lengthwise					
Electrical connection		SL	Plug					
Switching output, switching element function		PS	PNP, N/O contact, 3-wire					
Switching status display		LED	Yellow LED					
Rated operating voltage		24	24 V DC					

Proximity sensors SMT/CRSMT/SME-8, for T-slot

Type codes

CRSMT-8	
	CRSMT – 8 – PS – K2,5 – LED – 24
Function	
CRSMT	Proximity sensor, magneto-resistive, suitable for the food industry, resistant to acids and cooling lubricants
Design	
8	For T-slot, insertable in slot lengthwise
Switching output, switching element function	
PS	PNP, N/O contact, 3-wire
Electrical connection, cable length	
K2,5	Cable, 2.5 m
K5	Cable, 5.0 m
Switching status display	
LED	Yellow LED
Rated operating voltage	
24	24 V DC

SME-8-ZS-230V	
	SME – 8 – ZS – 230V – K2,5Q – OE
Function	
SME	Proximity sensor, magnetic reed
Design	
8	For T-slot, insertable in slot lengthwise
Switching output, switching element function	
ZS	N/O contact, 2-wire
Rated operating voltage	
230V	230 V AC/DC
Electrical connection, cable length, connection direction	
K2,5Q	Cable, 2.5 m, lateral
K5,0Q	Cable, 5.0 m, lateral
Connection technology	
OE	Open end

Proximity sensors SMT-8/CRSMT-8, for T-slot



Technical data – Magneto-resistive

Function

e.g. PNP, N/O contact, with plug

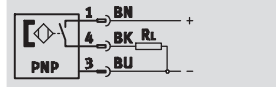

e.g. NPN, N/O contact, with plug

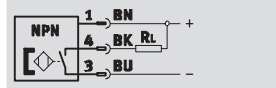

- Magneto-resistive measuring principle
- Insertable in slot lengthwise
- Corrosion-resistant designs

SMT-8-SL

- Sturdy thanks to long guides
- Plug directly on sensor



SMT-8



SMT-8-SL

General technical data				
Type	SMT-8		CRSMT	SMT-8-SL
Switching output	PNP	NPN	PNP	PNP
Design	For T-slot		For T-slot	For T-slot
Conforms to	–	EN 60947-5-2	EN 60947-5-2	–
Based on standard	EN 60947-5-2	–	–	EN 60947-5-2
Certification	C-Tick		C-Tick	C-Tick
CE mark (see declaration of conformity)	To EU EMC Directive		To EU EMC Directive	To EU EMC Directive
Note on materials	Free of copper and PTFE		Free of copper and PTFE	Free of copper and PTFE
	–	–	–	RoHS-compliant

Input signal/measuring element				
	SMT-8		CRSMT	SMT-8-SL
Measuring principle	Magneto-resistive		Magneto-resistive	Magneto-resistive
Ambient temperature [°C]	–20 ... +60		–20 ... +60	–20 ... +70

Switching output				
Type	SMT-8		CRSMT	SMT-8-SL
Switching output	PNP	NPN	PNP	PNP
Switching output	PNP	NPN	PNP	PNP
Switching element function	N/O contact		N/O contact	N/O contact
Reproducibility of switching value [mm]	±0.1		±0.1	–
Switch-on time [ms]	≤ 0.2	≤ 1	≤ 0.2	≤ 1
Switch-off time [ms]	≤ 0.5	≤ 0.8	≤ 0.5	3 ... 5
Max. switching frequency [Hz]	–		1 000	140
Max. output current [mA]	100		100	100
Max. switching capacity DC [W]	3		3	3
Voltage drop [V]	≤ 1.8	≤ 1.5	≤ 1.8	≤ 2
Residual current [µA]	≤ 100	≤ 2	≤ 100	≤ 1.5

Output, additional data				
Type	SMT-8		CRSMT	SMT-8-SL
Switching output	PNP	NPN	PNP	PNP
Protection against short circuit	Pulsed	Yes	Yes	Yes
Protection against overloading	Yes	–	–	Yes

Electronic components				
Type	SMT-8		CRSMT	SMT-8-SL
Switching output	PNP		PNP	PNP
Rated operating voltage [V DC]	–		–	24
Operating voltage range [V DC]	10 ... 30		10 ... 30	10 ... 30
Reverse polarity protection	For all electrical connections			

Proximity sensors SMT-8/CRSMT-8, for T-slot

FESTO

Technical data – Magneto-resistive

Electromechanical components						
Type	SMT-8				CRSMT	SMT-8-SL
Switching output	PNP		NPN		PNP	PNP
Electrical connection	Cable, 3-wire	Cable with plug, 3-pin	Cable, 3-wire	Cable with plug, 3-pin	Cable, 3-wire	Plug M8x1, 3-pin
Connection direction	In-line				–	In-line
Cable length [m]	2.5	0.3	2.5	0.3	2.5	–
	5	–	–	–	5	
Cable properties	Standard		–		–	–
Cable sheath material	Polyurethane				Thermoplastic polyolefin elastomer	–

Mechanical components						
Type	SMT-8				CRSMT	SMT-8-SL
Switching output	PNP		NPN		PNP	PNP
Electrical connection	Cable, 3-wire	Cable with plug M8x1, 3-pin	Cable, 3-wire	Cable with plug M8x1, 3-pin	Cable, 3-wire	Plug M8x1, 3-pin
Type of mounting	Clamped in T-slot				Clamped in T-slot	Screw-clamped
	Insertable in slot lengthwise				–	Insertable in slot lengthwise
Housing material	High-alloy stainless steel				High-alloy stainless steel	Polyamide
	Thermoplastic polyurethane elastomer				Polypropylene	–
	–	Brass	–	Brass	–	–
	–	Nickel-plated	–	Nickel-plated	–	–

Display/operation	
Switching status display	Yellow LED

Immissions/emissions			
Type	SMT-8	CRSMT	SMT-8-SL
Ambient temperature with flexible cable installation [°C]	–5 ... +60	–5 ... +60	–
Protection class	IP65	IP65	IP65
	IP67	IP68	IP68
	–	IP69K	–
Insulation voltage [V]	–	500	–
Degree of contamination	–	3	–
Corrosion resistance class CRC	2	4	3

Pin allocation to DIN EN 60947-5-2			
PS/NS			
Plug, 3-pin			
M8x1	Pin	Wire colour	Allocation
	1	Brown	+
	3	Blue	–
	4	Black	Output

Proximity sensors SMT-8/CRSMT-8, for T-slot

Technical data – Magneto-resistive

Dimensions

Download CAD data → www.festo.com

SMT-8-...S-K

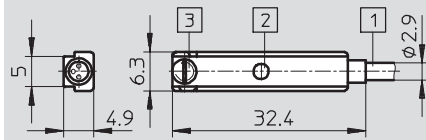

- 1 Connecting cable
- 2 Yellow LED
- 3 Clamping component

SMT-8-...S-S

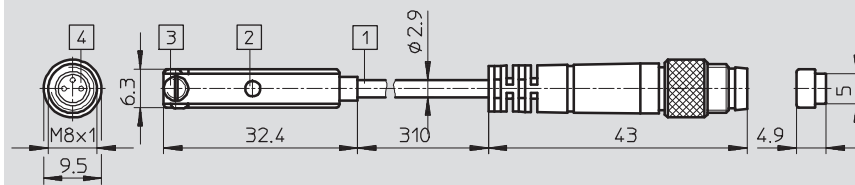

- 1 Connecting cable
- 2 Yellow LED
- 3 Clamping component
- 4 Plug to fit connecting cable NEBU-M8

CRSMT

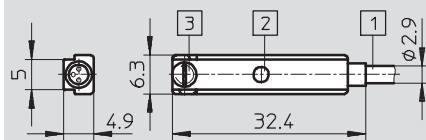

- 1 Connecting cable
- 2 Yellow LED
- 3 Clamping component

SMT-8-SL

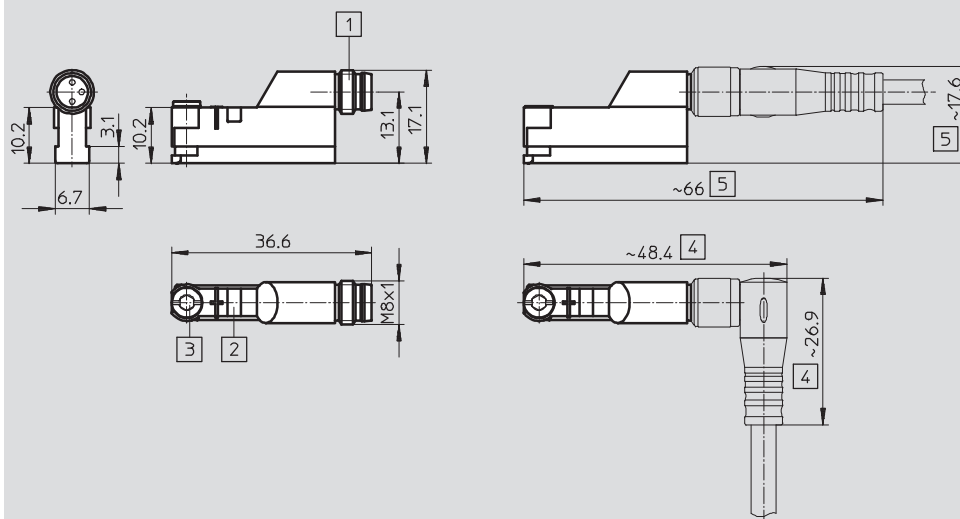

- 1 Plug to fit connecting cable NEBU-M8
- 2 Yellow LED
- 3 Clamping component
- 4 Fitting space for connecting cable NEBU-M8W3
- 5 Fitting space for connecting cable NEBU-M8G3

Ordering data

	Switching output	Electrical connection			Cable length [m]	Part No.	Type
		Cable	Cable with plug M8x1	Plug M8x1			
N/O contact, basic version							
	PNP	3-wire	-	-	2.5	175436	SMT-8-PS-K-LED-24-B
			-	3-pin	-	5.0	175434
	NPN	3-wire	-	-	0.3	175484	SMT-8-PS-S-LED-24-B
			-	3-pin	-	2.5	171180
	PNP	-	-	-	0.3	171181	SMT-8-NS-S-LED-24-B
			-	3-pin	-	-	562019

Proximity sensors SMT-8/CRSMT-8, for T-slot

FESTO

Technical data – Magneto-resistive

Ordering data							
	Switching output	Electrical connection			Cable length [m]	Part No.	Type
		Cable	Cable with plug M8x1	Plug M8x1			
N/O contact, corrosion resistant							
	PNP	3-wire	-	-	2.5	525563	CRSMT-8-PS-K-LED-24
					5.0	525564	CRSMT-8-PS-K5-LED-24

Proximity sensors SME-8, for T-slot

Technical data – Magnetic reed

Function

e.g. N/O contact, with cable, 3-wire

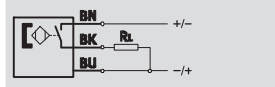

e.g. N/O contact, with plug, 3-pin

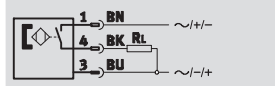

- Magnetic reed measuring principle
- Insertable in slot lengthwise

SME-8-SL

- Sturdy thanks to long guides
- Plug directly on sensor



SME-8



SME-8-SL

General technical data					
Type	SME-8-K	SME-8-S	SME-8-O	SME-8-ZS	SME-8-SL
Design	For T-slot				
Conforms to	EN 60947-5-2				
CE mark (see declaration of conformity)	To EU EMC Directive				
Note on materials	Free of copper and PTFE				RoHS-compliant
	-				

Input signal/measuring element							
Type	SME-8-K	SME-8-K5	SME-8-K-7,5	SME-8-S	SME-8-ZS	SME-8-O	SME-8-SL
Measuring principle	Magnetic reed						
Ambient temperature [°C]	-30 ... +60	-30 ... +70	-30 ... +70	-20 ... +70	-20 ... +60	-20 ... +60	-20 ... +60

Switching output					
Type	SME-8-K	SME-8-S	SME-8-ZS	SME-8-O	SME-8-SL
Switching output	Contacting, bipolar				
Switching element function	N/O contact	N/O contact	N/O contact	N/C contact	N/O contact
Reproducibility of switching value [mm]	±0.1	±0.1	±0.1	±0.1	±0.1
Switch-on time [ms]	≤ 0.5	≤ 0.5	≤ 0.5	≤ 2	≤ 0.6
Switch-off time [ms]	≤ 0.03	≤ 0.03	≤ 0.03	≤ 0.2	≤ 0.05
Max. switching frequency [Hz]	800	-	800	-	500
Max. output current [mA]	500	500	80	50	500
Max. switching capacity AC [VA]	10	10	-	1.5	10
Max. switching capacity DC [W]	10	10	2.16	1.5	10
Voltage drop [V]	0	-	≤ 3.5	≤ 2.5	0

Output, additional data	
Protection against short circuit	No
Protection against overloading	No

Electronic components					
Type	SME-8-K	SME-8-S	SME-8-ZS	SME-8-O	SME-8-SL
Operating voltage range [V AC]	12 ... 30	12 ... 30	-	12 ... 30	10 ... 30
Operating voltage range [V DC]	12 ... 30	12 ... 30	12 ... 27	12 ... 30	10 ... 30
Reverse polarity protection	No				

Proximity sensors SME-8, for T-slot

Technical data – Magnetic reed

Electromechanical components							
Type	SME-8-K	SME-8-K5	SME-8-K-7,5	SME-8-S	SME-8-ZS	SME-8-O	SME-8-SL
Electrical connection	Cable, 3-wire			Cable with plug M8x1, 3-pin	Cable, 2-wire	Cable, 3-wire	Plug M8x1, 3-pin
Connection direction	In-line						
Cable length [m]	2.5	5	7.5	0.3	2.5	7.5	–
Cable sheath material	Polyurethane						

Mechanical components							
Type	SME-8-K	SME-8-K5	SME-8-K-7,5	SME-8-S	SME-8-ZS	SME-8-O	SME-8-SL
Type of mounting	Clamped in T-slot Insertable in slot lengthwise						
Housing material	Epoxy resin						
	Polycarbonate						
	Polybutylene terephthalate						
	–				High-alloy stainless steel	–	

Display/operation	
Switching status display	Yellow LED

Immissions/emissions							
Type	SME-8-K	SME-8-K5	SME-8-K-7,5	SME-8-S	SME-8-ZS	SME-8-O	SME-8-SL
Ambient temperature with flexible cable installation [°C]	–5 ... +60	–5 ... +70	–5 ... +70	–5 ... +70	–5 ... +60	–5 ... +60	–
Protection class	IP65			–	IP65	–	IP65
	IP67			IP67	IP67	IP67	IP67
Insulation voltage [V]	50						
Surge capacity [kV]	3	3	3	3	3	3	3
Degree of contamination	3						

Pin allocation to EN 60947-5-2			
S			
Plug, 3-pin			
M8x1	Pin	Wire colour	Allocation
	1	Brown	+
	3	Blue	–
	4	Black	Output

Proximity sensors SME-8, for T-slot

Technical data – Magnetic reed



Dimensions

Download CAD data → www.festo.com

N/O contact, cable

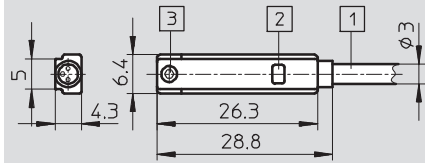

- 1 Connecting cable
- 2 Yellow LED
- 3 Clamping component

N/C contact, cable

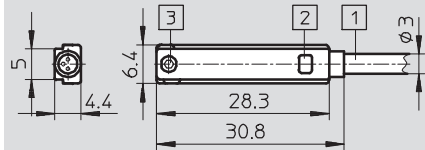

- 1 Connecting cable
- 2 Yellow LED
- 3 Clamping component

Plug M8x1

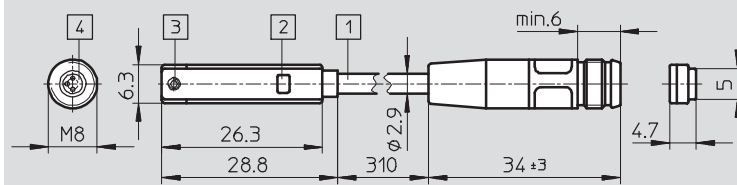

- 1 Connecting cable
- 2 Plug to fit connecting cable NEBU-M8
- 3 Clamping component
- 4 Yellow LED

Ordering data

	Switching output	Electrical connection			Cable length [m]	Part No.	Type
		Cable	Cable with plug M8x1	Plug M8x1			
N/O contact, basic version							
	Contacting, bipolar	3-wire	–	–	2.5	150855	SME-8-K-LED-24
			–	–	5.0	175404	SME-8-K5-LED-24
		–	3-pin	–	0.3	150857	SME-8-S-LED-24
		2-wire	–	–	2.5	171169	SME-8-ZS-KL-LED-24
	Contacting, bipolar	–	–	3-pin	–	526622	SME-8-SL-LED-24
N/C contact							
	Contacting, bipolar	3-wire	–	–	7.5	160251	SME-8-O-K-LED-24

- 7 - To be discontinued SME-8-ZS-230V
Available until 2010

Proximity sensors SME-8, for T-slot

FESTO

Technical data – Magnetic reed

Function

e.g. N/O contact, with cable, 2-wire,
0 ... 30 V AC/DC

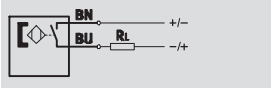

e.g. N/O contact, with cable, 2-wire,
5 ... 250 V AC/DC

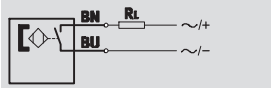

- Magnetic reed measuring principle
- Insertable in slot lengthwise
- Heat-resistant design
- Variants with operating voltage range up to 250 V DC/AC

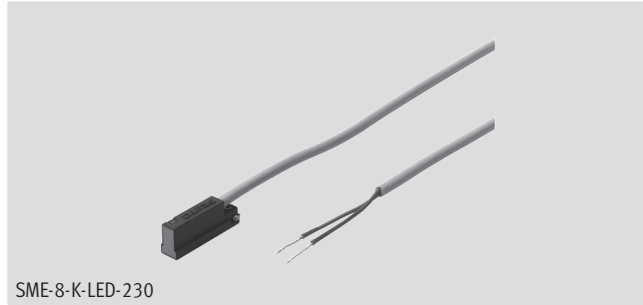

SME-8-K-LED-230

General technical data			
	SME-8-...-S6	SME-8-...-230	SME-8-ZS-230V-...
Design	For T-slot		
Conforms to	EN 60947-5-2	EN 60947-5-2	-
CE mark (see declaration of conformity)	-	To EU EMC Directive	
	-	To EU Low Voltage Directive	
Note on materials	Free of copper and PTFE		

Input signal/measuring element			
	SME-8-...-S6	SME-8-...-230	SME-8-ZS-230V-...
Measuring principle	Magnetic reed		
Ambient temperature	[°C] -40 ... +120	-40 ... +60	-20 ... +60

Switching output			
	SME-8-...-S6	SME-8-...-230	SME-8-ZS-230V-...
Switching output	Contacting, bipolar	Contacting, bipolar, without LED function	Contacting, bipolar
Switching element function	N/O contact		
Reproducibility of switching value	[mm] ±0.1	±0.1	±0.1
Switch-on time	[ms] ≤ 0.5	2	≤ 2
Switch-off time	[ms] ≤ 0.03	0.03	≤ 0.1
Max. switching frequency	[Hz] 800	500	50
Max. output current	[mA] 500	120	120
Max. switching capacity AC	[VA] 10		
Max. switching capacity DC	[W] 10		
Voltage drop	[V] ≤ 0	≤ 3.9	≤ 4
Residual current	[mA] -	0	0

Output, additional data			
	SME-8-...-S6	SME-8-...-230	SME-8-ZS-230V-...
Protection against short circuit	No		
Protection against overloading	No		

Electronic components			
	SME-8-...-S6	SME-8-...-230	SME-8-ZS-230V-...
Operating voltage range	[V AC] 0 ... 30	3 ... 230	5 ... 250
Operating voltage range	[V DC] 0 ... 30	3 ... 230	5 ... 250
Reverse polarity protection	No		

- 2 - To be discontinued SME-8-ZS-230V
Available until 2010

Proximity sensors SME-8, for T-slot

Technical data – Magnetic reed

FESTO

Electromechanical components			
	SME-8-...-S6	SME-8-...-230	SME-8-ZS-230V-...
Electrical connection	Cable, 2-wire		
Connection direction	In-line		Lateral
Cable length [m]	2.5	2.5	2.5
	–	–	5
Cable sheath material	Thermoplastic styrene elastomer	Polyurethane	Thermoplastic polyurethane elastomer

Mechanical components			
	SME-8-...-S6	SME-8-...-230	SME-8-ZS-230V-...
Type of mounting	Clamped in T-slot		
	Insertable in slot lengthwise		
Housing material	Epoxy resin		
	Polycarbonate		
	Polyethylene terephthalate		
	High-alloy stainless steel		

Display/operation			
	SME-8-...-S6	SME-8-...-230	SME-8-ZS-230V-...
Switching status display	–	Yellow LED	Yellow LED

Immissions/emissions			
	SME-8-...-S6	SME-8-...-230	SME-8-ZS-230V-...
Ambient temperature with flexible cable installation [°C]	–5 ... +120	–5 ... +60	–5 ... +60
Protection class	–	–	IP65
	IP67	IP67	IP67
Insulation voltage [V]	50	–	250
Surge capacity [kV]	0.8	4	4
Degree of contamination	3	3	–

Dimensions Download CAD data → www.festo.com

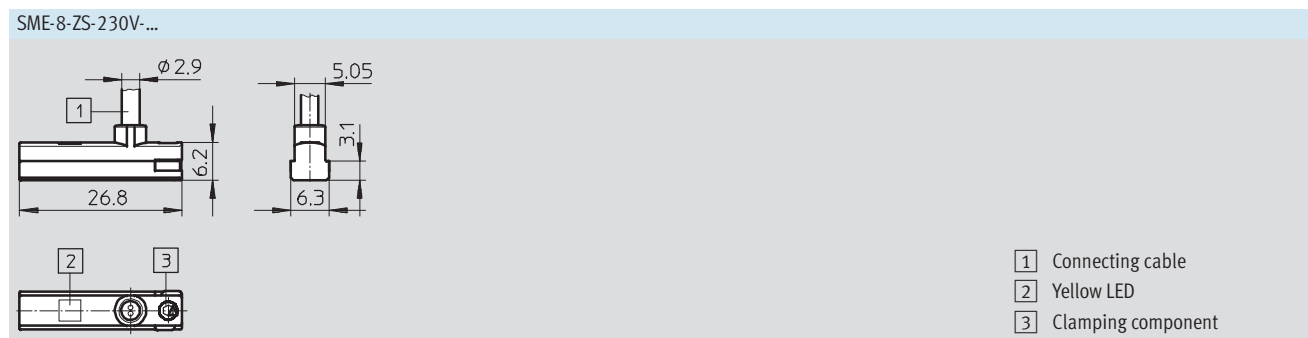
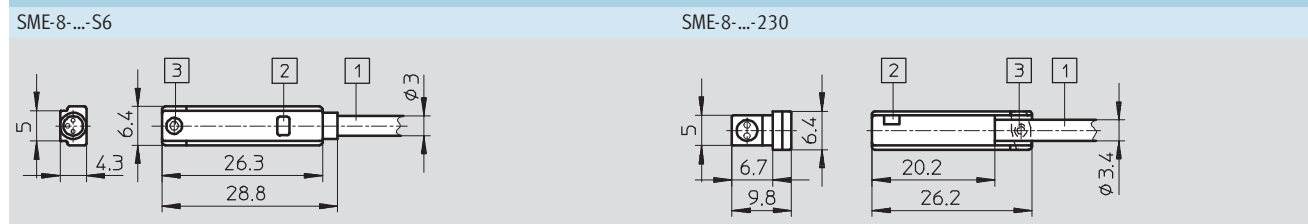

- 7 - To be discontinued SME-8-ZS-230V
Available until 2010

Proximity sensors SME-8, for T-slot

FESTO

Technical data – Magnetic reed

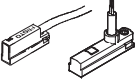
Ordering data							
	Switching output	Electrical connection	Connection direction	Cable length [m]	Part No.	Type	
		Cable					
N/O contact, heat resistant							
	Contacting, bipolar	2-wire	In-line	2.5	161756	SME-8-K-24-S6	
N/O contact, operating voltage range up to 250 V AC/DC							
	Contacting, bipolar	2-wire	In-line	2.5	152820	SME-8-K-LED-230	
			Lateral	2.5	538816	SME-8-ZS-230V-K2,5Q-OE	- 7 -
				5.0	538817	SME-8-ZS-230V-K5,0Q-OE	- 7 -

Proximity sensors SMT-8G, for T-slot

Type codes

SMT-8G

		SMT	8G	PS	24V	E	2,5Q	OE
Function								
SMT	Proximity sensor, magneto-resistive							
Design								
8G	For T-slot, insertable in slot lengthwise							
Switching output, switching element function								
PS	PNP, N/O contact, 3-wire							
Rated operating voltage								
24V	24 V DC							
Cable properties								
E	Energy chain + robot applications							
Cable length [m], connection direction								
2,5Q	Cable, 2.5 m, lateral ¹⁾							
0,3Q	Cable with plug, 0.3 m, lateral ²⁾							
Electrical connection								
OE	Open end							
M5D	Cable with plug M5x0.5, rotatable thread							
M8D	Cable with plug M8x1, rotatable thread							

- 1) Only with electrical connection OE
- 2) Not with electrical connection OE

Proximity sensors SMT-8G, for T-slot

Technical data – Magneto-resistive

Function

PNP, N/O contact, with cable, 3-wire

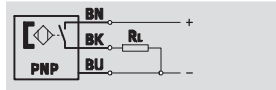

PNP, N/O contact, with plug

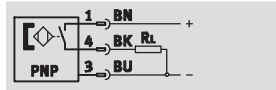

- Magneto-resistive measuring principle
- Insertable in slot lengthwise
- Design ideally matched to gripper sensing

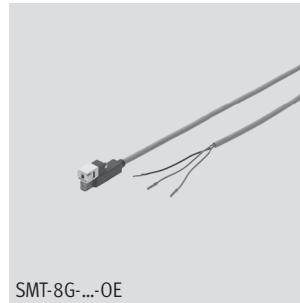

General technical data	
Design	For T-slot
Based on standard	EN 60947-5-2
CE mark (see declaration of conformity)	To EU EMC Directive
Note on materials	Free of copper and PTFE RoHS-compliant

Input signal/measuring element	
Measuring principle	Magneto-resistive
Ambient temperature	[°C] -20 ... +70

Switching output	
Switching output	PNP
Switching element function	N/O contact
Max. output current	[mA] 80
Max. switching capacity DC	[W] 2.4

Output, additional data	
Protection against short circuit	Pulsed
Protection against overloading	Yes

Electronic components	
Operating voltage range	[V DC] 10 ... 30
Reverse polarity protection	For all electrical connections

Electromechanical components			
Type	SMT-8G-...-OE	SMT-8G-...-M5D	SMT-8G-...-M8D
Electrical connection	Cable, 3-wire	Cable with plug M5x0.5, 3-pin, rotatable thread	Cable with plug M8x1, 3-pin, rotatable thread
Connection direction	Lateral		
Cable test conditions	Energy chain: 5 million cycles, bending radius 28 mm		
	Torsional strength: > 300,000 cycles, ±270°/0.1 m		
	Resistance to bending: to Festo standard; test conditions on request		
Cable length	[m] 2.5	0.3	0.3
Cable properties	Energy chain + robot applications		
Cable sheath material	Thermoplastic polyurethane elastomer		

Mechanical components	
Type of mounting	Clamped in T-slot
	Insertable in slot lengthwise
Housing material	Reinforced polyamide

Proximity sensors SMT-8G, for T-slot

FESTO

Technical data – Magneto-resistive

Display/operation	
Switching status display	Yellow LED

Immissions/emissions	
Ambient temperature with flexible cable installation	–5 ... +70 °C
Protection class	IP65 IP68

Pin allocation to DIN EN 60947-5-2			
PS			
Plug, 3-pin			
M5x0.5, M8x1	Pin	Wire colour	Allocation
	1	Brown	+
	3	Blue	-
	4	Black	Output

Dimensions Download CAD data → www.festo.com

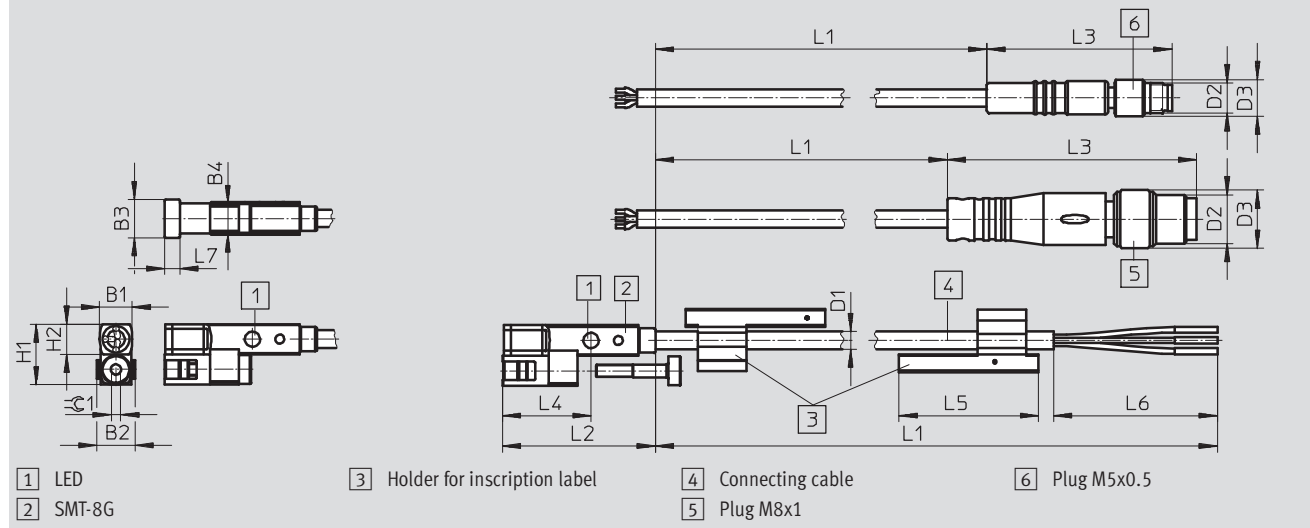

	D1	D2	D3	B1	B2	B3	B4	H1	H2	L1	L2	L3	L4	L5	L6	L7	
SMT-8G-...-OE	2.9	-	-	5.4	5	6.3	5	10	5	2500 +70	25	-	14.4	23	50	2.5	1.5
SMT-8G-...-M8D		M8x1	9.6							41.1							
SMT-8G-...-M5D		M5x0.5	6							30.5							

Ordering data							
Switching output	Electrical connection			Cable length	Part No.	Type	
	Cable	Cable with plug, rotatable thread					
		M5x0.5	M8x1	[m]			
N/O contact							
	PNP	3-wire	-	-	2.5	547859 SMT-8G-PS-24V-E-2,5-OE	
		-	3-pin	-	-	0.3	547861 SMT-8G-PS-24V-E-0,3-M5D
		-	-	3-pin	-	-	547860 SMT-8G-PS-24V-E-0,3-M8D

Proximity sensors SME-8-FM, for T-slot

Type codes

SME-8-FM		SME	8	FM	DS	24V	K	1,0	OE
Function									
SME	Proximity sensor, magnetic reed								
Design									
8	For T-slot								
Sensor design									
FM	Screw-clamped in slot, insertable from above								
Switching output									
DS	3-wire N/O contact								
ZS	2-wire N/O contact								
Nominal operating voltage									
24V	24 V AC/DC								
Cable properties									
K	Standard								
Cable length [m]									
1,0	1								
Electrical connection									
OE	Open end								

Proximity sensors SME-8-FM, for T-slot

Technical data – Magnetic reed

Function

N/O contact, with cable, 3-wire

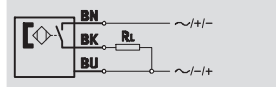

N/O contact, with cable, 2-wire

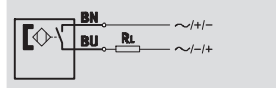

- Magnetic reed measuring principle
- Insertable in slot from above



SME-8-FM-DS



SME-8-FM-ZS

General technical data	
Design	For T-slot
Based on standard	EN-60947-5-2
Certification	C-Tick
CE mark (see declaration of conformity)	To EU EMC Directive
Note on materials	Free of copper and PTFE RoHS-compliant

Input signal/measuring element	
Measuring principle	Magnetic reed
Ambient temperature	[°C] -10 ... +60

Switching output		
Type	SME-8-FM-DS	SME-8-FM-ZS
Switching output	Contacting, bipolar	
Switching element function	N/O contact	
Max. output current	[mA] 100	
Max. switching capacity AC	[VA] 3	
Max. switching capacity DC	[W] 3	

Output, additional data	
Protection against short circuit	No
Protection against overloading	No

Electronic components		
Operating voltage range	[V AC] 10 ... 30	
Operating voltage range	[V DC] 10 ... 30	

Electromechanical components		
Type	SME-8-FM-DS	SME-8-FM-ZS
Electrical connection	Cable, 3-wire	Cable, 2-wire
Connection direction	In-line	
Cable test conditions	Test conditions on request	
Cable length	[m] 1	
Cable properties	Standard	
Cable sheath material	Polyvinyl chloride	

Mechanical components		
Type	SME-8-FM-DS	SME-8-FM-ZS
Type of mounting	Screw-clamped Insertable in slot from above	
Housing material	Polyamide	

Proximity sensors SME-8-FM, for T-slot

Technical data – Magnetic reed

Display/operation	
Switching status display	Yellow LED

Immissions/emissions	
Ambient temperature with flexible cable installation	[-5 ... +60] °C
Protection class	IP67

Dimensions Download CAD data → www.festo.com

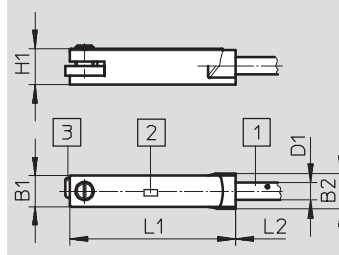

- 1 Connecting cable
- 2 Yellow LED
- 3 Clamping component

	B1	B2	D1	H1	L1	L2
SME-8-FM	5.1	5.8	2.9	6	27.4	1 000

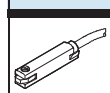
Ordering data						
	Switching output	Electrical connection	Cable length [m]	Part No.	Type	
		Cable				
	Contacting, bipolar	3-wire	1	562515	SME-8-FM-DS-24V-K-1,0-OE	
		2-wire	1	562516	SME-8-FM-ZS-24V-K-1,0-OE	

Proximity sensors SMT0/SMTSO/SME0-8E, for T-slot

Type codes

SMT0/SMTSO/SME0-8E	
SMT0 – 8E – PS – M12 – LED – 24 –	
Function	
SMT0	Proximity sensor, magneto-resistive
SMTSO	Proximity sensor, magneto-inductive, welding field immune
SME0	Proximity sensor, magnetic reed
Design	
8E	For T-slot, mounting via accessories
Switching output, switching element function	
PS	PNP, N/O contact, 3-wire
NS	NPN, N/O contact, 3-wire
Electrical connection, cable length	
K	Cable, 2.5 m or 7.5 m
S	Plug M8x1
M12	Plug M12x1
Switching status display	
LED	Yellow LED
Rated operating voltage	
24	24 V DC
230	230 V AC
Variant	
S6	Heat resistant

Proximity sensors SMTO-8E/SMTSO-8E, for T-slot

Technical data – Magneto-resistive

Technical data		SMTO-8E	SMTSO-8E, welding field immune
Type of mounting		Via accessories	
Electrical connection		Plug M8x1, 3-pin	Plug M12x1, 3-pin
		Plug M12x1, 3-pin	
Operating voltage range DC	[V]	10 ... 30	
Max. output current	[mA]	100	200
Max. switching capacity DC	[W]	3.0	6.0
Protection against short circuit		Yes	
Protection against overloading		No	
Reverse polarity protection		For all electrical connections	
Resistance to interference from magnetic fields		–	Alternating magnetic field 45 ... 65 Hz
Protection class		IP65, IP67	

Operating and environmental conditions		SMTO-8E	SMTSO-8E, welding field immune
Ambient temperature	[°C]	–20 ... +60	–25 ... +70
CE mark (see declaration of conformity)		To EU EMC Directive	

Materials		SMTO-8E	SMTSO-8E, welding field immune
Housing		Polyurethane	Polyamide

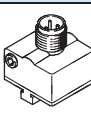
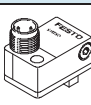
Ordering data					
	Switching output	Electrical connection		Part No.	Type
		Plug M8x1	Plug M12x1		
N/O contact, basic version					
	PNP	3-pin	–	171178	SMTO-8E-PS-S-LED-24
		–	3-pin	171179	SMTO-8E-PS-M12-LED-24
	NPN	3-pin	–	171166	SMTO-8E-NS-S-LED-24
		–	3-pin	171176	SMTO-8E-NS-M12-LED-24
N/O contact, welding field immune					
	PNP	–	3-pin	191986	SMTSO-8E-PS-M12-LED-24
	NPN	–	3-pin	175825	SMTSO-8E-NS-M12-LED-24

-  - Note
 Mounting kit not included in the scope of delivery. Corresponding mounting kits, peripherals overview
 → 6

Proximity sensors SMEO-8E, for T-slot

FESTO

Technical data – Magnetic reed

Technical data		
Type of mounting	Via accessories	
Electrical connection	Plug M8x1, 3-pin	Plug M12x1, 3-pin
Operating voltage range DC	[V]	12 ... 30
Max. output current	[mA]	500
Max. switching capacity DC	[W]	10.0
Protection against short circuit	No	
Protection against overloading	No	
Reverse polarity protection	No	
Protection class	IP65, IP67	

Operating and environmental conditions		
Ambient temperature	[°C]	-20 ... +60
CE mark (see declaration of conformity)	To EU EMC Directive	

Materials	
Housing	Polyurethane

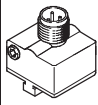
Ordering data					
	Switching output	Electrical connection		Part No.	Type
		Plug M8x1	Plug M12x1		
N/O contact, basic version					
	Contacting, bipolar	3-pin	-	171163	SMEO-8E-S-LED-24
		-	3-pin	171164	SMEO-8E-M12-LED-24

-  - Note
 Mounting kit not included in the scope of delivery. Corresponding mounting kits, peripherals overview
 → 6

Proximity sensors SMEO-8E, for T-slot

Technical data – Magnetic reed

Technical data		SMEO-8E-...-S6	SMEO-8E-...-230
Type of mounting		Via accessories, insertable in slot from above	
Electrical connection		Cable, 2-wire	Plug M12x1, 3-pin
Operating voltage range DC	[V]	0 ... 30	3 ... 250
Operating voltage range AC	[V]	0 ... 30	3 ... 250
Max. output current	[mA]	500	120
Max. switching capacity DC	[W]	10.0	10.0
Max. switching capacity AC	[VA]	10.0	10.0
Protection against short circuit		No	
Protection against overloading		No	
Reverse polarity protection		No	
Protection class		IP65, IP67	

Operating and environmental conditions		SMEO-8E-...-S6	SMEO-8E-...-230
Ambient temperature	[°C]	-40 ... +120	-20 ... +60
Ambient temperature with flexible cable installation	[°C]	-40 ... +120	-
CE mark (see declaration of conformity)		Not necessary	To EU EMC Directive To EU Low Voltage Directive

Materials		SMEO-8E-...-S6	SMEO-8E-...-230
Housing		Polyurethane	
Cable sheath		Thermoplastic styrene elastomer	-

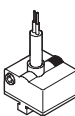
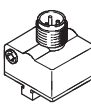
Ordering data						
	Switching output	Electrical connection		Cable length [m]	Part No.	Type
		Cable	Plug			
N/O contact, heat resistant						
	Contacting, bipolar	2-wire	-	2.5	171158	SMEO-8E-K-24-S6
N/O contact, operating voltage range 3 ... 250 V AC/DC						
	Contacting, bipolar	-	3-pin	-	171160	SMEO-8E-M12-LED-230

-  - Note
 Mounting kit not included in the scope of delivery. Corresponding mounting kits, peripherals overview
 → 6

Proximity sensors SMT/SME-8, for T-slot

Accessories

Mounting kit SMBR-8-8/100-S6

Materials:

Rail: Anodised wrought aluminium alloy

Clamping strap, screws: High-alloy stainless steel

Free of copper and PTFE

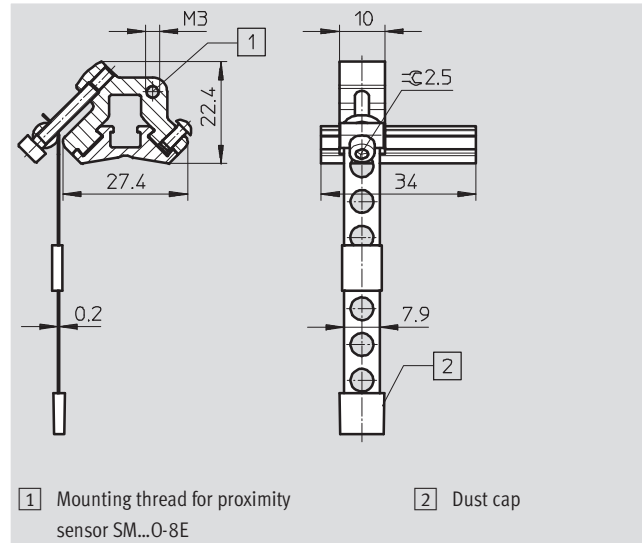

Dimensions and ordering data			
For piston \varnothing	Corrosion resistance class CRC ¹⁾	Part No.	Type
8 ... 100	4	538937	SMBR-8-8/100-S6

1) Corrosion resistance class 4 according to Festo standard 940 070
 Components subject to particularly high corrosion stress. Parts used with aggressive media, e.g. in the food or chemical industry. These applications should be supported with special tests with the media if required.

Mounting kit SMBR

Material:

Polyacetal

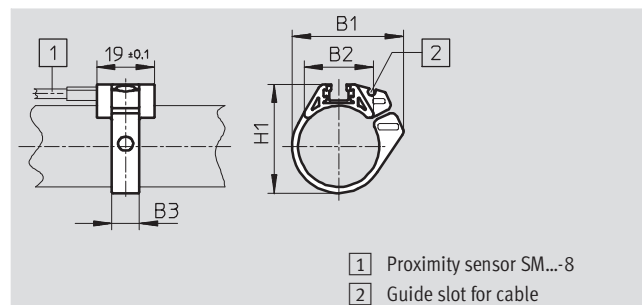

Dimensions and ordering data						
For piston \varnothing	B1	B2	B3	H1	Part No.	Type
8	18.9	12.3	7	17.5	175091	SMBR-8-8
10	20.4	13.7	7	19.9	175092	SMBR-8-10
12	22.7	14.3	7	21.9	175093	SMBR-8-12
16	26.1	17.1	7	25.7	175094	SMBR-8-16
20	33.2	20.8	9	30.4	175095	SMBR-8-20
25	36.5	22.6	9	35.6	175096	SMBR-8-25
32	41.7	24.6	9	42.7	175097	SMBR-8-32
40	47.1	26.5	9	50.7	175098	SMBR-8-40
50	56.4	28.6	9	61.5	175099	SMBR-8-50
63	69.4	32	9	74.5	175100	SMBR-8-63

Proximity sensors SMT/SME-8, for T-slot

Accessories

Mounting kit CRSMB

Materials:
 Housing: Polyurethane
 Rail: Hard anodised aluminium
 Free of copper and PTFE

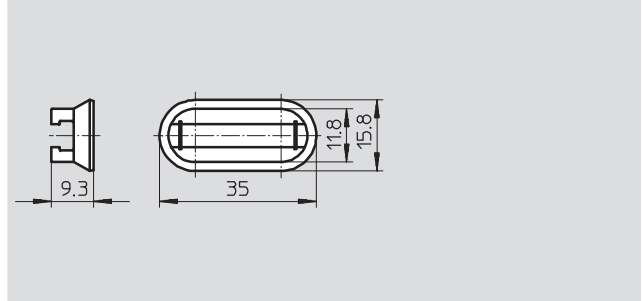

Dimensions and ordering data			
For piston \varnothing	Part No.	Type	
32 ... 100	525565	CRSMB-8-32/100	

 Note
 The mounting kit is secured to the cylinder using the double-sided adhesive tape provided.

Mounting kit SMB-8-FENG

Material:
 Wrought aluminium alloy
 Free of copper and PTFE

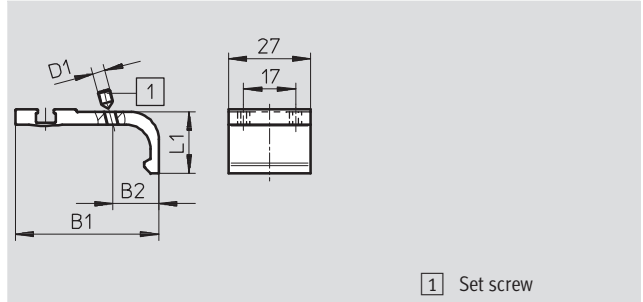
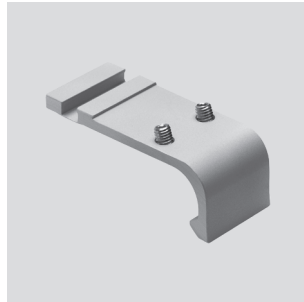

1 Set screw

Dimensions and ordering data						
For piston \varnothing	B1	B2	D1	L1	Tightening torque [Nm]	Part No. Type
32/40	35.1	8.7	M3	15.5	0.2	175705 SMB-8-FENG-32/40
50/63	47	12.3	M4	20	0.5	175706 SMB-8-FENG-50/63
80/100	64.3	15.7	M5	24.3	0.7	175707 SMB-8-FENG-80/100

Mounting kit SMB-8E

Material:
 Polyacetal

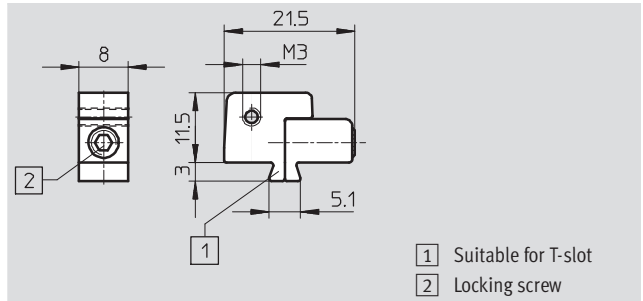
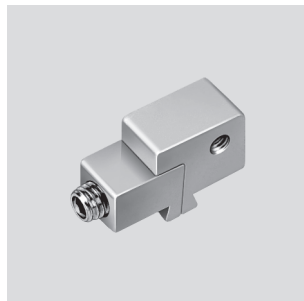

1 Suitable for T-slot
 2 Locking screw

Ordering data		
For piston \varnothing	Part No.	Type
10 ... 125	178230	SMB-8E

Proximity sensors SMT/SME-8, for T-slot

Accessories



Mounting SMBZ-8-...

Materials:
 Rail: Anodised wrought aluminium alloy
 Screws: High-alloy stainless steel
 Free of copper and PTFE

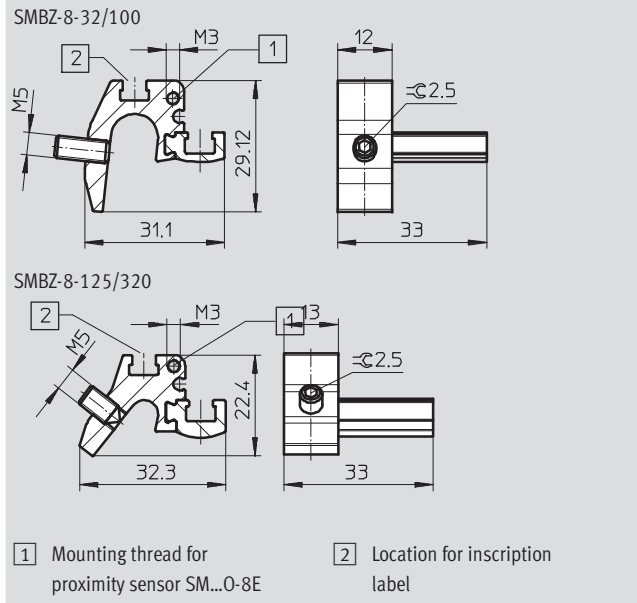

Ordering data		
For piston \varnothing	Part No.	Type
32 ... 100	537806	SMBZ-8-32/100
125 ... 320	537808	SMBZ-8-125/320

Positioning component SMM

Insertable in slot lengthwise

Ambient temperature: $-40 \dots +120 \text{ }^\circ\text{C}$

Materials:
 Housing: Anodised wrought aluminium alloy
 Screws: High-alloy stainless steel
 Note on materials: RoHS-compliant

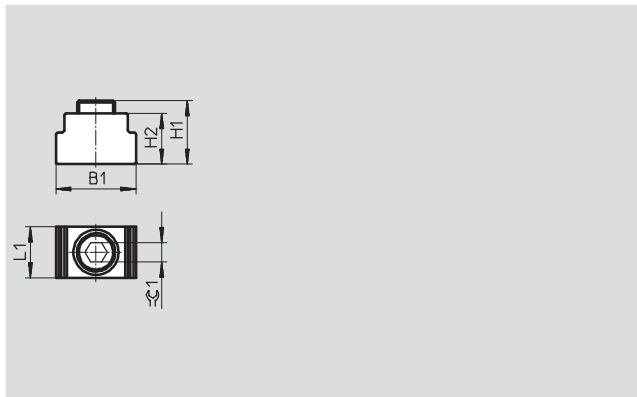
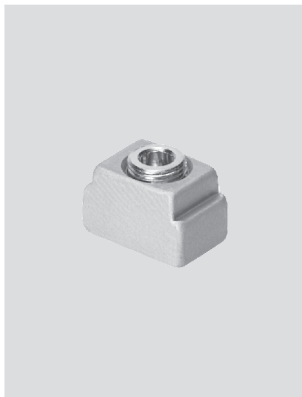





Dimensions and ordering data							Part No.	Type	PU ²⁾
B1	H1	H2	L1	$\varnothing 1$	CRC ¹⁾				
6.3	5.0	4.0	4.0	1.5	3	547941	SMM-8	10	



1) Corrosion resistance class 4 according to Festo standard 940 070
 Components subject to particularly high corrosion stress. Parts used with aggressive media, e.g. in the food or chemical industry. These applications should be supported with special tests with the media if required.
 2) Packaging unit

Proximity sensors SMT/SME-8, for T-slot

Accessories

FESTO

Ordering data – Connecting cables		Technical data → Internet: nebu			
		Number of wires	Cable length [m]	Part No.	Type
Socket M5x0.5, 4-pin					
	For SMT/SME-8M and SMT-8G	3	2.5	539508	NEBU-M5G4-K-5-Q3-LE3
			1.0	539510	NEBU-M5G4-K-1-Q3-M8G3
		4	1.0	539512	NEBU-M5G4-K-1-Q3-M12G4
Socket M8x1, 3-pin					
	For SMT/SME-8... and SMT0/SMTSO/SME0-8E	3	2.5	541333	NEBU-M8G3-K-2.5-LE3
			5	541334	NEBU-M8G3-K-5-LE3
	For SMT/SME-8... and SMT0/SMTSO/SME0-8E	3	2.5	541338	NEBU-M8W3-K-2.5-LE3
			5	541341	NEBU-M8W3-K-5-LE3
Socket M12x1, 5-pin					
	For SMT/SME-8M and SMT0/SMTSO/SME0-8E	3	2.5	541363	NEBU-M12G5-K-2.5-LE3
			5	541364	NEBU-M12G5-K-5-LE3
	For SMT/SME-8M and SMT0/SMTSO/SME0-8E	3	2.5	541367	NEBU-M12W5-K-2.5-LE3
			5	541370	NEBU-M12W5-K-5-LE3

Ordering data – Inscription labels, safety clips				
	Size	Part No.	Type	PU ¹⁾
	23x4 mm	541598	ASLR-L-423	34
	M8	548067	NEAU-M8-GD	1
	M12	548068	NEAU-M12-GD	1

1) Packaging unit per frame

Ordering data – Mounting attachments			
	For Ø	Part No.	Type
	-	534254	SMBK-8

Ordering data – Sensor tester		
	Part No.	Type
	158481	SM-TEST-1