

San Ace 80

9RA type

DC Fan

Features

Low Noise and Energy Saving

Compared to our current model,⁽¹⁾ noise level has been reduced by 3 dB(A) and power consumption has been reduced by 25.5%.⁽²⁾ Moreover, the models with PWM control, which enables the control of fan speed, provide further optimized noise level and efficiency.

Rich Lineup

The product lineup is available in a wide variety in different 12/24/48 voltage, cooling performance, noise level, and PWM control. This allows users to choose the most suitable one for their applications.

(1) Current model: 80 x 80 x 38 mm *San Ace 80* 9G type DC Fan (model: 9G0812G101).
 (2) For models 9RA0812G1001



80x80x38 mm

Specifications

The models listed below **have ribs and pulse sensors with PWM control function**. For models without ribs, append "1" to the end of model numbers.

Model no.	Rated voltage [V]	Operating voltage range [V]	PWM duty cycle* [%]	Rated current [A]	Rated input [W]	Rated speed [min ⁻¹]	Max. airflow [m ³ /min] [CFM]	Max. static pressure [Pa] [inchH ₂ O]	SPL [dB(A)]	Operating temperature [°C]	Expected life [h]
9RA0812P1K001	12	10.8 ~ 13.2	100	1.52	18.24	8250	2.96 104.5	307 1.23	53	-20 ~ +70	40000/60°C (70000/40°C)
			20	0.13	1.56	2500	0.90 31.8	27.7 0.11	21		
9RA0812P1G001			100	0.82	9.84	6750	2.42 85.5	206 0.83	48		
			20	0.08	0.96	1800	0.65 22.9	14.6 0.06	15		
9RA0812P1H001			100	0.66	7.92	6100	2.19 77.3	168 0.67	46		
			20	0.08	0.96	1500	0.54 19.0	10.2 0.04	13		
9RA0824P1G001	24	21.6 ~ 26.4	100	0.41	9.84	6750	2.42 85.5	206 0.83	48		
			20	0.08	1.92	2800	1.00 35.3	35.4 0.14	24		
9RA0848P1G001	48	43.2 ~ 52.8	100	0.22	10.56	6750	2.42 85.5	206 0.83	48		
			20	0.05	2.40	3000	1.07 37.8	40.7 0.16	26		

* PWM frequency is 25 kHz. Models without ratings for 0% PWM duty cycle have zero speed at 0%. When control terminal is open, speed is the same as at 100% duty cycle.

The models listed below **have ribs and pulse sensors**. For models without ribs, append "1" to the end of model numbers.

Model no.	Rated voltage [V]	Operating voltage range [V]	Rated current [A]	Rated input [W]	Rated speed [min ⁻¹]	Max. airflow [m ³ /min] [CFM]	Max. static pressure [Pa] [inchH ₂ O]	SPL [dB(A)]	Operating temperature [°C]	Expected life [h]
9RA0812K1001	12	7 ~ 13.2	1.52	18.24	8250	2.96 104.5	307 1.23	53	-20 ~ +70	40000/60°C (70000/40°C)
9RA0812G1001		7 ~ 13.8	0.82	9.84	6750	2.42 85.5	206 0.83	48		
9RA0812H1001		0.66	7.92	6100	2.19 77.3	168 0.67	46			
9RA0824G1001	24	14 ~ 27.6	0.41	9.84	6750	2.42 85.5	206 0.83	48		
9RA0824H1001			0.33	7.92	6100	2.19 77.3	168 0.67	46		
9RA0848G1001	48	36 ~ 55.2	0.22	10.56	6750	2.42 85.5	206 0.83	48		
9RA0848H1001			0.18	8.64	6100	2.19 77.3	168 0.67	46		

Models with the following sensor specifications are also available as options: **Without sensor** **Lock sensor**

Common Specifications

- Material Frame: Plastic (Flammability: UL 94V-0), Impeller: Plastic (Flammability: UL 94V-1)
- Expected life Refer to specifications
(L10 life: 90% survival rate for continuous operation in free air at 60°C, rated voltage)
Expected life at 40°C is for reference only.
- Motor protection function Locked rotor burnout protection, Reverse polarity protection
- Dielectric strength 50/60 Hz, 500 VAC, for 1 minute (between lead wire conductors and frame)
- Insulation resistance 10 MΩ min. at 500 VDC (between lead wire conductors and frame)
- Sound pressure level (SPL) A-weighted sound pressure level (SPL) at 1 m away from the air inlet.
- Operating temperature Refer to specifications (Non-condensing)
- Storage temperature -30 to +70°C (Non-condensing)
- Lead wire ⊕ Red ⊖ Black **Sensor** Yellow **Control** Brown
(For models without PWM control function, there is no speed control wiring.)
- Mass 170 g

Airflow - Static Pressure Characteristics

PWM duty cycle

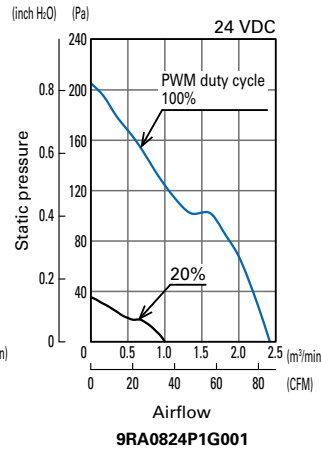
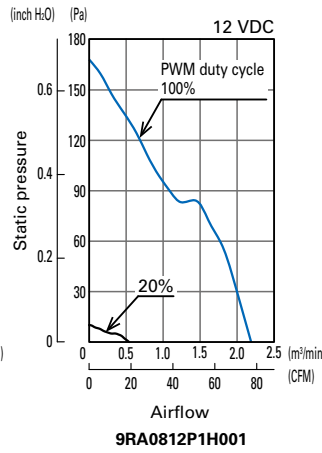
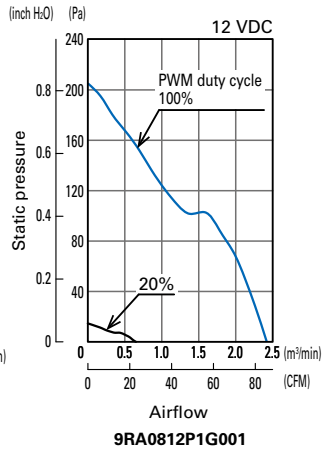
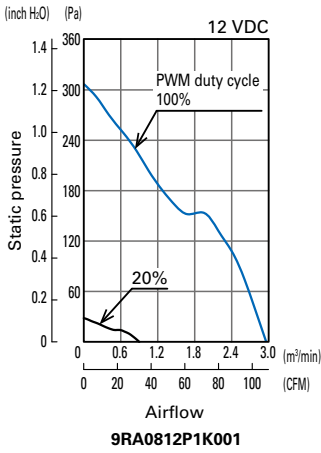

PWM duty cycle

Operating voltage range

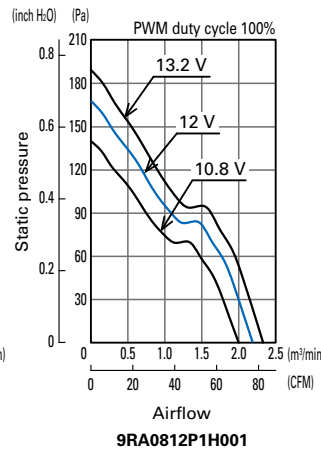
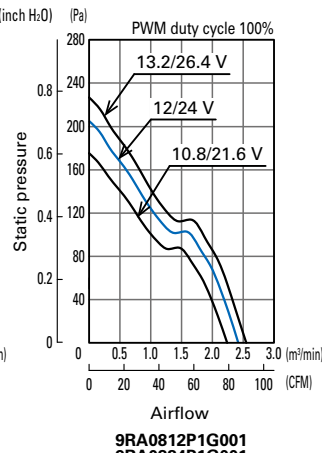
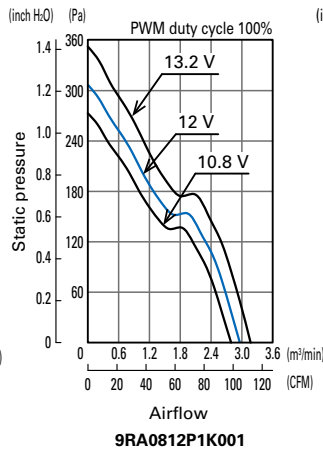
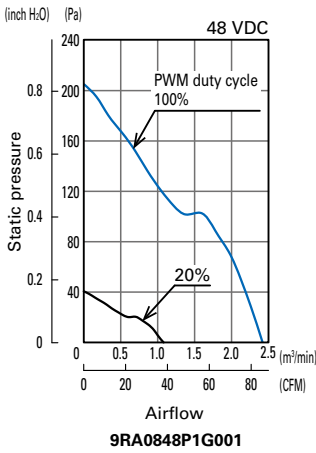

Operating voltage range

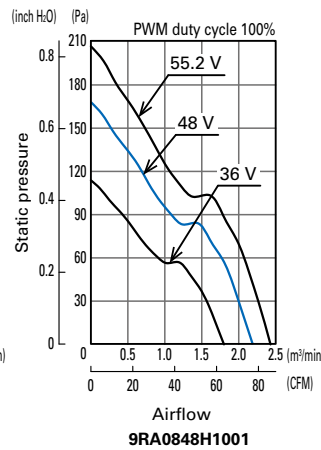
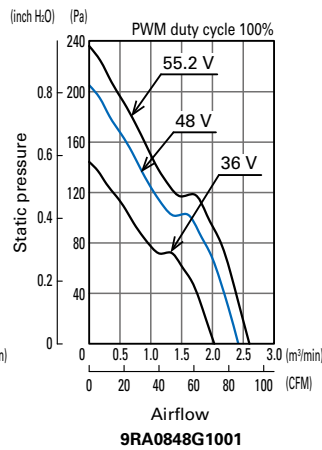
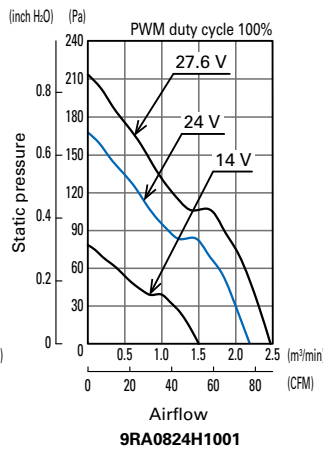
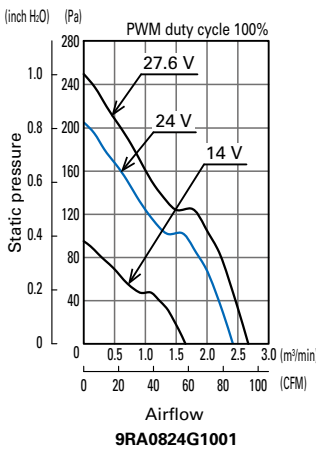
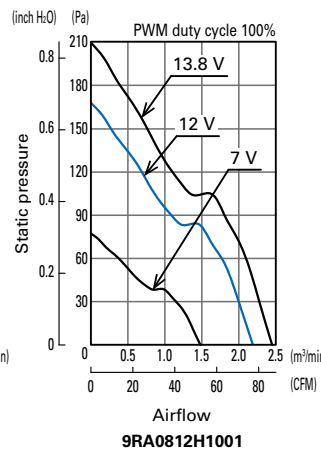
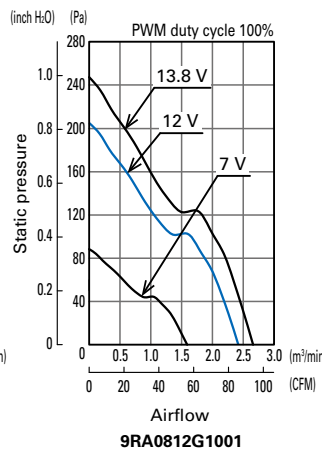
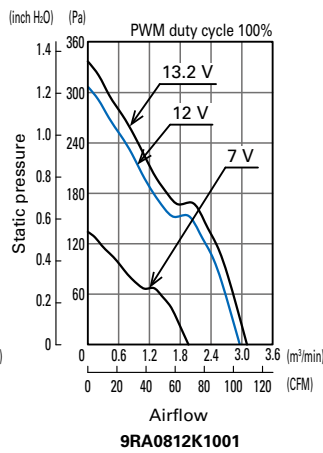
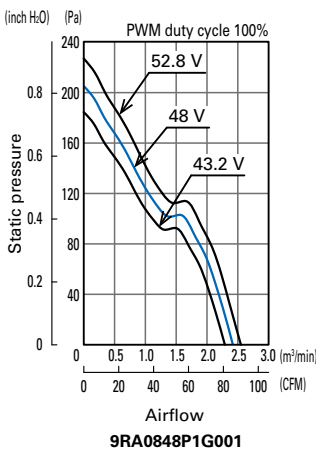

PWM Duty - Speed Characteristics Example

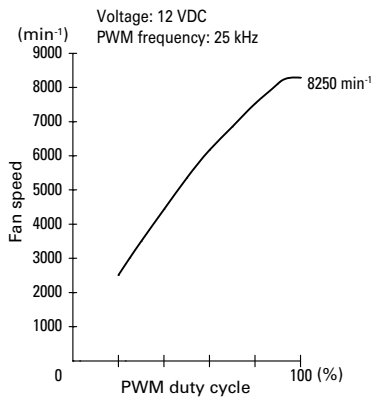

9RA0812P1K001

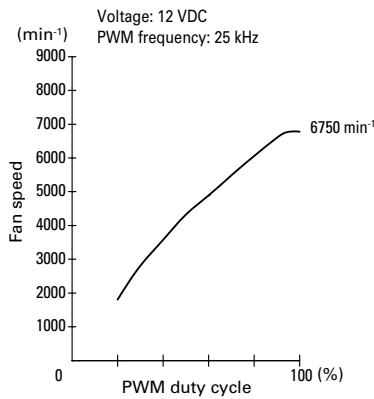

9RA0812P1G001

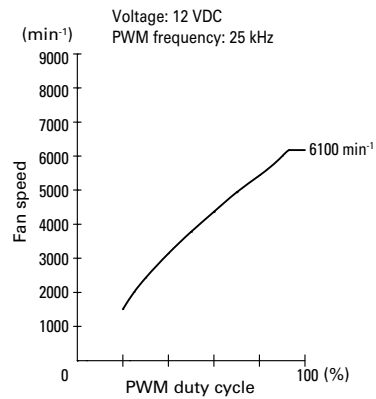

9RA0812P1H001

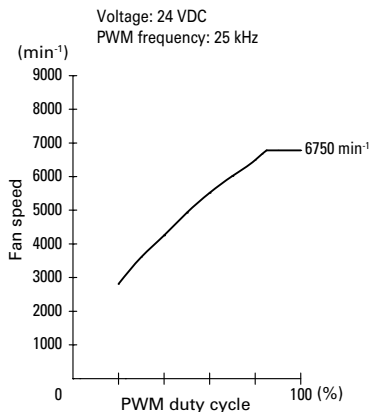

9RA0824P1G001

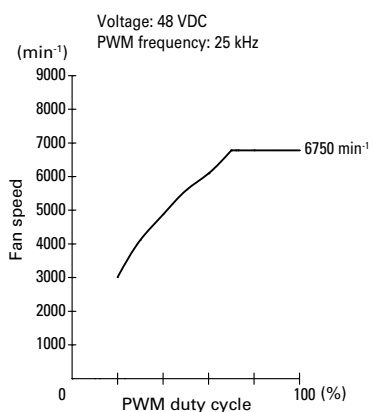

9RA0848P1G001

PWM Input Signal Example

Input signal waveform

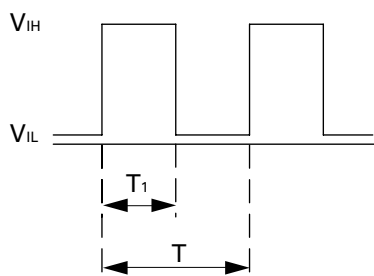

$V_{IH} = 4.75 \text{ to } 5.25 \text{ V}$ $V_{IL} = 0 \text{ to } 0.4 \text{ V}$

$\text{PWM duty cycle (\%)} = \frac{T_1}{T} \times 100$ $\text{PWM frequency } 25 \text{ (kHz)} = \frac{1}{T}$

Current source (I_{source}) = 1.0 mA max. (when control voltage is 0 V)

Current sink (I_{sink}) = 1.0 mA max. (when control voltage is 5.25 V)

When the PWM control terminal is open, the fan speed is the same as the speed at 100% PWM duty cycle. The PWM signal can be used with open collector or drain input. Note that when using an open collector or drain input, or inputting a different voltage or frequency, the speed relative to the PWM duty cycle may differ from this specification.

Example of Connection Schematic

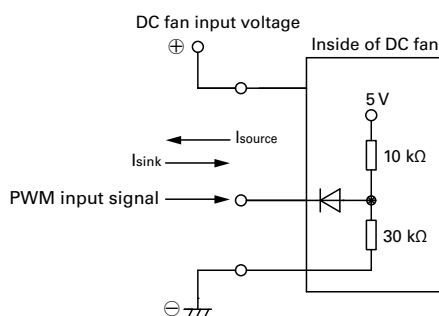

Specifications for Pulse Sensors

Output circuit: Open collector

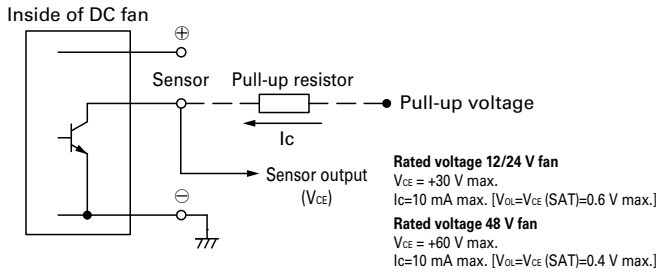

Output waveform (Need pull-up resistor)

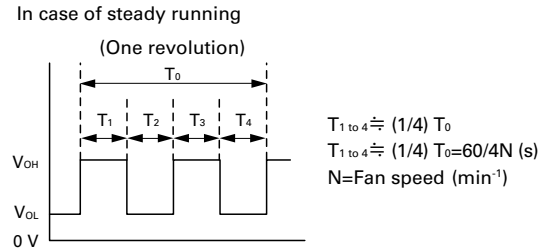

Dimensions (unit: mm) (Ribbed frame with pulse sensor with PWM control function)

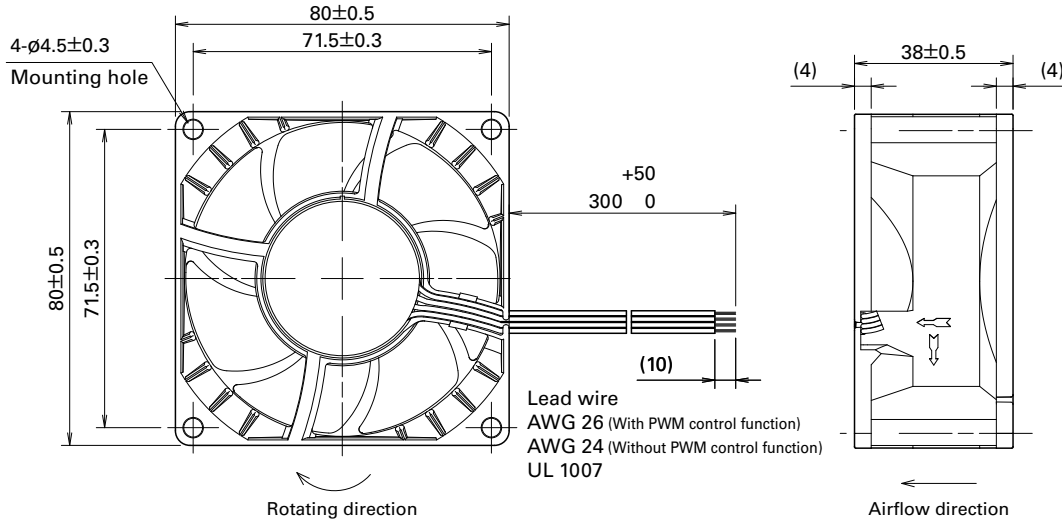

Reference Dimensions of Mounting Holes and Vent Opening (unit: mm)

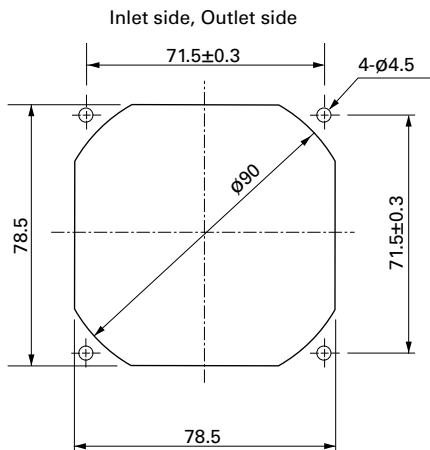

Options

Finger guards

Model no.: 109-049E, 109-049H, 109-049C

Notice

- Please read the "Safety Precautions" on our website before using the product.
- The products shown in this catalog are subject to Japanese Export Control Law. Diversion contrary to the law of exporting country is prohibited.
- For protecting fan bearings against electrolytic corrosion near strong electromagnetic noise sources, we provide effective countermeasures such as Electrolytic Corrosion Proof Fans and EMC guards. Contact us for details.

SANYO DENKI CO., LTD. 3-33-1 Minami-Otsuka, Toshima-ku, Tokyo 170-8451, Japan TEL: +81 3 5927 1020

<https://www.sanyodenki.com/>

The names of companies and/or their products specified in this catalog are the trade names, and/or trademarks and/or registered trademarks of such respective companies. San Ace, SANUPS, and SANMOTION are trademarks of SANYO DENKI CO., LTD.

Specifications are subject to change without notice.

CATALOG No. C1132B001 '22.6