

# General Purpose EMC/EMI Line Filter



- Three-phase and neutral line filter for general four-wire filtering tasks
- Choice of connection style
- Low operating leakage current
- Compliant with IEC 60950
- Suitable to meet EN 55011/14/22



### Performance indicators

Attenuation performance

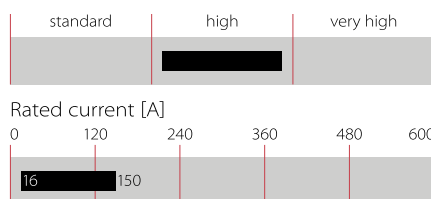

## Technical specifications

<b>Maximum continuous operating voltage</b>	3x 440/250 VAC
<b>Operating frequency</b>	DC to 60 Hz
<b>Rated currents</b>	16 to 150 A @ 40°C max.
<b>High potential test voltage</b>	P → E 2000 VAC for 2 sec P → P 1900 VDC for 2 sec
<b>Protection category</b>	IP 20 (filters with connectors -29, -33, -34) IP 00 (filters with connectors -06, -24, -28)
<b>Overload capability</b>	4x rated current at switch on, 1.5x rated current for 1 minute, once per hour
<b>Temperature range (operation and storage)</b>	-25°C to +100°C (25/100/21)
<b>Flammability corresponding to</b>	UL 94 V-2 or better
<b>Design corresponding to</b>	UL 1283, CSA 22.2 No. 8 1986, IEC/EN 60939
<b>MTBF @ 40°C/400 V (Mil-HB-217F)</b>	220,000 hours

### Approvals



(FN 356 up to 100 A)

### Features and benefits

- FN 356 represents the industry standard filter solutions for EMC compliance on three-phases and the neutral conductor, providing high attenuation of both symmetrical and asymmetrical interference
- Choice of connection style is offered for an application-specific filter selection
- Solid touch-safe terminal blocks (-29, -33, -34 versions) offer a generous contacting cross section and contribute to overall safety (IP 20)
- Used as a mains input filter, FN 356 filters increase the conducted immunity and thus contribute to system reliability
- Design compliance with IEC 60950 provides additional application flexibility



### Typical applications

- General purpose four-wire filtering
- Mainframe computer systems
- High power office equipment
- UPS
- Installations comprising automation equipment

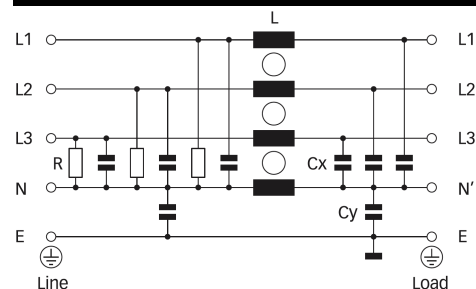
### Typical electrical schematic



### Filter selection table

Filter*	Rated current @ 40°C (25°C)	Leakage current** @ 400 VAC/50 Hz	Power loss @ 25 °C/ 50Hz	Input/Output connections			Weight
	[A]	[mA]	[W]				[kg]
FN 356-16-..	16 (18.4)	0.43	7.0	-06		-29	1.2
FN 356-25-..	25 (28.8)	0.43	10.1		-24	-33	1.5
FN 356-36-..	36 (41.5)	0.43	10.9		-24	-33	1.6
FN 356-50-..	50 (57.7)	0.43	15.8		-24	-33	2.3
FN 356-100-..	100 (115.0)	1.33	24.0		-28	-34	5.9
FN 356-150-28	150 (172.5)	8.00	45.9		-28		8.1

\* To compile a complete part number, please replace the .. with the required I/O connection style.

\*\* Maximum leakage under normal operating conditions, based on the assumption that all three phases and the neutral conductor are connected to the supply and the consumer. In this case, the current will mainly return through the neutral line, not as earth leakage.

### Typical filter attenuation

Per CISPR 17; A=50 Ω/50 Ω sym; B=50 Ω/50 Ω asym; C=0.1 Ω/100 Ω sym; D=100 Ω/0.1 Ω sym

16 A types

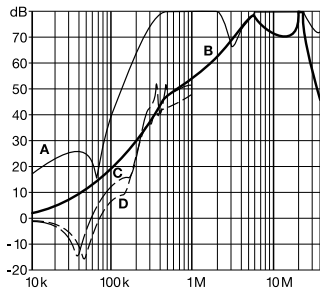

25 to 50 A types

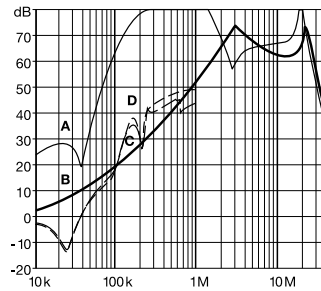

100 A types

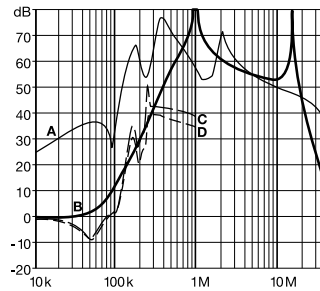

150 A types

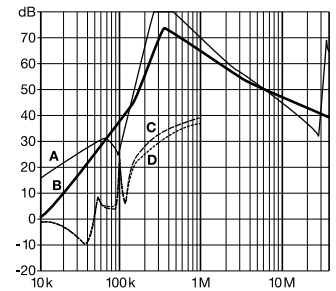

### Mechanical data

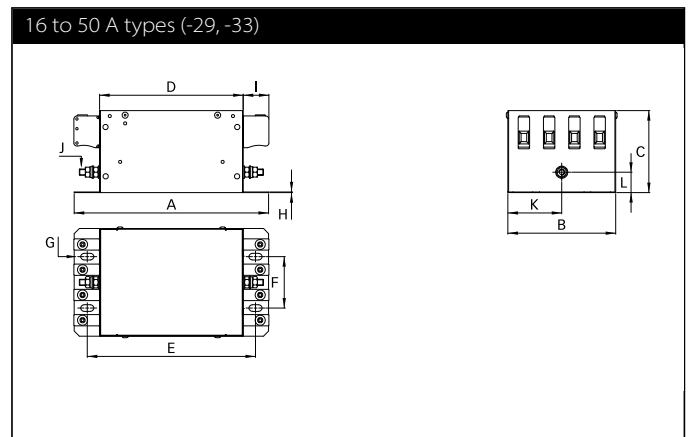
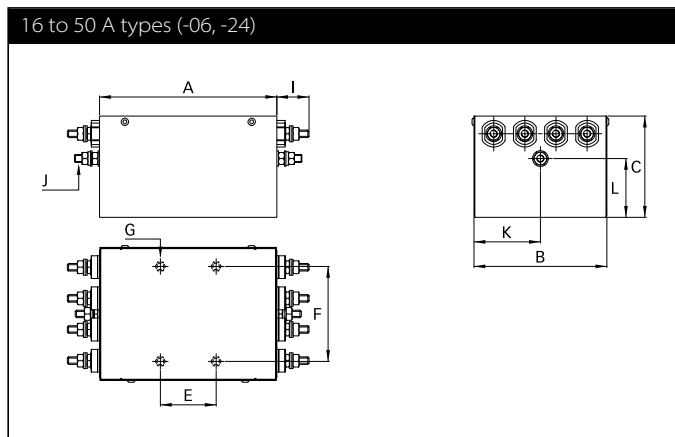

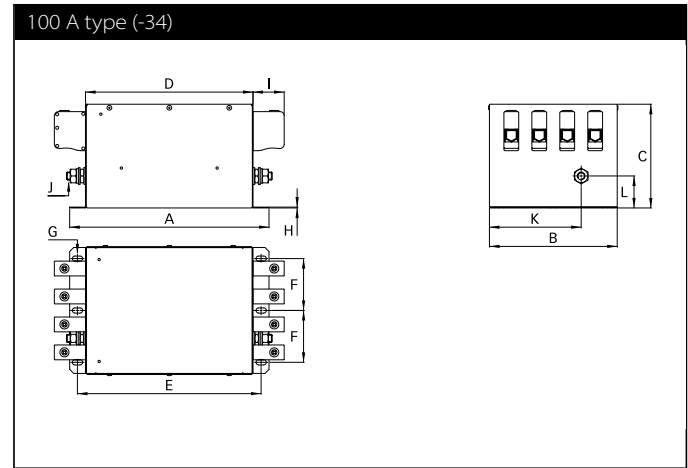
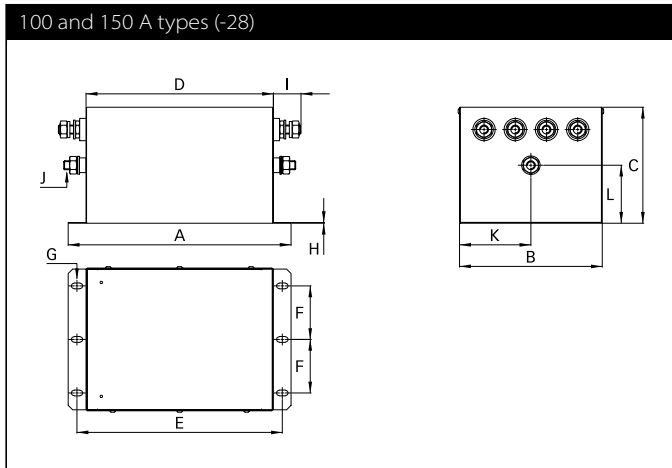

Note: in favour of a better readability, connectors and earth studs are not shown in the horizontal projection.

## Dimensions

	16 A (-06)	16 A (-29)	25 A (-24)	25 A (-33)	36 A (-24)	36 A (-33)	50 A (-24)	50 A (-33)	100 A (-28)	100 A (-34)	150 A
<b>A</b>	149	189.5	140	189.5	140	189.5	143.25	192	250	250	340
<b>B*</b>	104	105	105	105	105	105	122	122	160	160	160
<b>C</b>	50	80	80	80	80	80	102	102	130	130	130
<b>D</b>		140		140		140		142.5	210	210	300
<b>E</b>	44 ±0.3	165.5	44 ±0.3	165.5	44 ±0.3	165.5	44 ±0.3	168	230	230	320
<b>F</b>	75 ±0.3	80	75 ±0.3	50	75 ±0.3	50	75 ±0.3	98	60	65	60
<b>G</b>	M5 x 7	13 x 6.5	M5 x 7	13 x 6.5	M5 x 7	13 x 6.5	M5 x 7	13 x 6.5	13 x 6.5	13 x 6.5	13 x 6.5
<b>H</b>		0.7		0.7		0.7		0.7	1	1	1
<b>I</b>	11	10.9	25.4	25	25.4	25	25.4	25	34	39	34
<b>J</b>	6.3 x 0.8	M6	M6	M6	M6	M6	M6	M6	M10	M10	M10
<b>K</b>	52	82	52.5	52.5	52.5	52.5	61	61	80	116	80
<b>L</b>	22.5	25	46.5	20	46.5	20	68.5	35	65	40	65

\* Rivets exceed this dimension by max. 1.3mm on each side.

All dimensions in mm; 1 inch = 25.4 mm

Tolerances according: ISO 2768-m/EN 22768-m

## Filter input/output connector cross sections

	-06 (6.3 x 0.8mm)	-24 (M6)	-28 (M10)	-29	-33	-34
<b>Solid wire</b>	n/a	n/a	n/a	6 mm <sup>2</sup>	16 mm <sup>2</sup>	35 mm <sup>2</sup>
<b>Flex wire</b>	n/a	n/a	n/a	4 mm <sup>2</sup>	10 mm <sup>2</sup>	25 mm <sup>2</sup>
<b>AWG type wire</b>	n/a	n/a	n/a	AWG 10	AWG 6	AWG 2
<b>Recommended torque</b>	n/a	3.5-4.0 Nm	15-17 Nm	0.6-0.8 Nm	1.5-1.8 Nm	4.0-4.5 Nm

Please visit [www.schaffner.com](http://www.schaffner.com) to find more details on filter connectors.



## Headquarters, global innovation and development

### Switzerland

#### Schaffner Group

Nordstrasse 11  
4542 Luterbach  
T +41 32 681 66 26  
[info@schaffner.com](mailto:info@schaffner.com)  
<http://www.schaffner.com>



## Sales and application centers

### China

#### Schaffner EMC Ltd. Shanghai

T20-3 C, No 565 Chuangye Road,  
Pudong district  
201201 Shanghai  
T +86 21 3813 9500  
[cschina@schaffner.com](mailto:cschina@schaffner.com)  
<http://www.schaffner.com.cn>

### Finland

#### Schaffner Oy

Sauvonrinne 19 H  
08500 Lohja  
T +358 50 468 7284  
[finlandsales@schaffner.com](mailto:finlandsales@schaffner.com)

### France

#### Schaffner EMC S.A.S.

16-20 Rue Louis Rameau  
95875 Bezons  
T +33 1 34 34 30 60  
F +33 1 39 47 02 28  
[francesales@schaffner.com](mailto:francesales@schaffner.com)

### Germany

#### Schaffner Deutschland GmbH

Schoemperlenstrasse 12B  
76185 Karlsruhe  
T +49 721 56910  
F +49 721 569110  
[germanysales@schaffner.com](mailto:germanysales@schaffner.com)

### India

#### Schaffner India Pvt. Ltd

Unit 59, Level, Mfar Greenheart 7  
Manyata Tech Park, Hebbal Outer Ring Road  
560045 Bangalore  
T +91 80 6781 9805  
F +91 80 6781 9998  
[indiasales@schaffner.com](mailto:indiasales@schaffner.com)

### Italy

#### Schaffner EMC S.r.l.

Via Ticino, 30  
20900 Monza (MB)  
T +39 039 21 41 070  
[italysales@schaffner.com](mailto:italysales@schaffner.com)

### Japan

#### Schaffner EMC K.K.

1-32-12, Kamiyama, Setagaya-ku  
7F Mitsui-seimei Sengenjaya Bldg.  
154-0011 Tokyo  
T +81 3 5712 3650  
F +81 3 5712 3651  
[japansales@schaffner.com](mailto:japansales@schaffner.com)  
<http://www.schaffner.jp>

### Singapore

#### Schaffner EMC Pte Ltd.

#05-09, Kg Ubi Ind. Estate  
408705 Singapore  
T +65 6377 3283  
F +65 6377 3281  
[singaporesales@schaffner.com](mailto:singaporesales@schaffner.com)

### Spain

#### Schaffner EMC España

Calle Caléndula 93, Miniparc III, Edificio E  
El Soto de Moraleja, Alcobendas  
28109 Madrid  
T +34 917 912 900  
F +34 917 912 901  
[spainsales@schaffner.com](mailto:spainsales@schaffner.com)

### Sweden

#### Schaffner EMC AB

Tegeluddsvägen 76, 2tr  
115 28 Stockholm  
T +46 8 5050 2425  
[swedensales@schaffner.com](mailto:swedensales@schaffner.com)  
<http://www.schaffner.com>

### Switzerland

#### Schaffner EMV AG

Nordstrasse 11  
4542 Luterbach  
T +41 32 681 66 26  
[switzerlandsales@schaffner.com](mailto:switzerlandsales@schaffner.com)

### Taiwan R.O.C.

#### Schaffner EMV Ltd.

20 Floor-2, No 97, Section 1, XinTai 5th Road  
22175 XiZhi District New Taipei City 22175  
T +886 2 2697 5500  
F +886 2 2697 5533  
[taiwansales@schaffner.com](mailto:taiwansales@schaffner.com)  
<http://www.schaffner.com.tw>

### Thailand

#### Schaffner EMC Co. Ltd.

Northern Region Industrial Estate  
67 Moo 4 Tambon Ban Klang  
Amphur Muangng P.O. Box 14  
51000 Lamphun  
T +66 53 58 11 04  
F +66 53 58 10 19  
[thailandsales@schaffner.com](mailto:thailandsales@schaffner.com)

### United Kingdom

#### Schaffner Ltd.

5 Ashville Way, Molly Millars Lane  
Wokingham  
RG41 2PL Berkshire  
T +44 118 9770070  
F +44 118 9792969  
[uksales@schaffner.com](mailto:uksales@schaffner.com)

### USA

#### Schaffner EMC Inc.

52 Mayfield Avenue  
08837 Edison, New Jersey  
T +1 800 367 5566  
T +1 732 225 9533  
F +1 732 225 4789  
[usasales@schaffner.com](mailto:usasales@schaffner.com)  
<http://www.schaffnerusa.com>

#### Schaffner North America

6722 Thirlane Road  
24019 Roanoke, Virginia  
T +1 276 228 7943  
F +1 276 228 7953

#### Schaffner North America

823 Fairview Road  
24382 Wytheville, Virginia  
T +1 276 228 7943  
F +1 276 228 7258

To find your local partner within Schaffner's global network: [www.schaffner.com](http://www.schaffner.com)

© 2017 Schaffner Group

The content of this document has been carefully checked and understood. However, neither Schaffner nor its subsidiaries assume any liability whatsoever for any errors or inaccuracies of this document and the consequences thereof. Published specifications are subject to change without notice. Product suitability for any area of application must ultimately be determined by the customer. In all cases, products must never be operated outside their published specifications. Schaffner does not guarantee the availability of all published products. This disclaimer shall be governed by substantive Swiss law and resulting disputes shall be settled by the courts at the place of business of Schaffner Holding AG. Latest publications and a complete disclaimer can be downloaded from the Schaffner website. All trademarks recognized.