

<b>Order Code</b>	<b>TCK-019</b>
<b>Inductance</b> (each winding)	620 $\mu$ H $\pm$ 35% (at 100 kHz / 100 mV)
<b>Impedance</b> (DCR)	80 m $\Omega$ max.
<b>Rated Current</b>	1.7 A max.
<b>Rated Voltage</b>	500 VDC max. (between windings)
<b>Operating Temperature</b>	-40°C to +105°C
<b>RoHS Exemptions</b>	No Exemptions

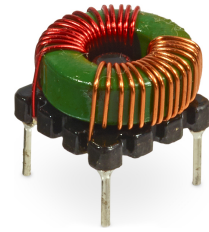

### Impedance Curve

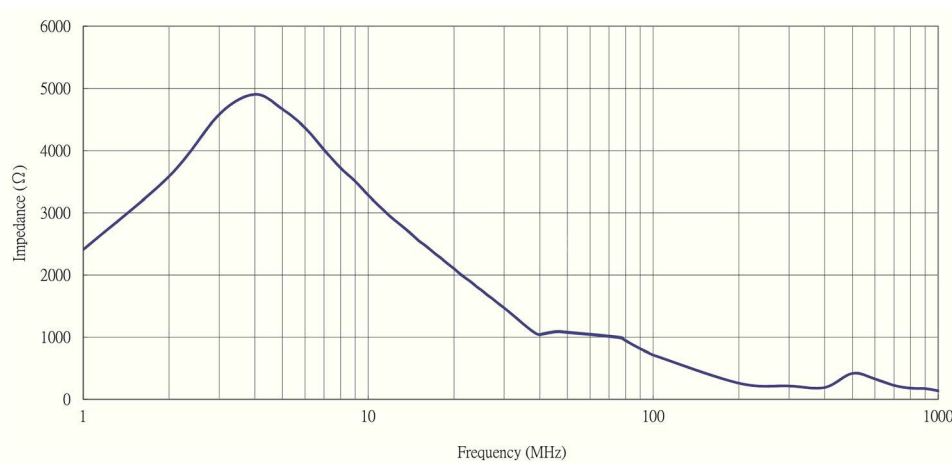

### Outline Dimensions

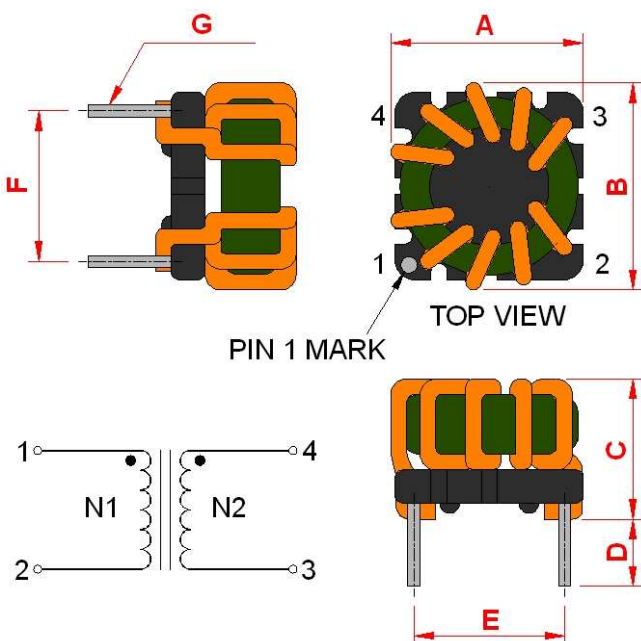

Dimensions [mm]	
<b>A</b>	11.5 max.
<b>B</b>	11.5 max.
<b>C</b>	8.8 max.
<b>D</b>	2.5 min.
<b>E</b>	7.62 $\pm$ 0.2
<b>F</b>	7.62 $\pm$ 0.2
<b>G</b>	$\varnothing$ 0.6 $\pm$ 0.1

All specifications valid at +25°C, unless otherwise stated.