

<b>Order Code</b>	<b>TCK-154</b>
<b>Inductance</b>	4.7 $\mu$ H $\pm$ 20% (at 1 kHz / 1 V)
<b>Impedance (DCR)</b>	109 m $\Omega$ max.
<b>Rated Current</b>	1.15 A max.
<b>Operating Temperature</b>	-40°C to +125°C
<b>RoHS Exemptions</b>	No Exemptions

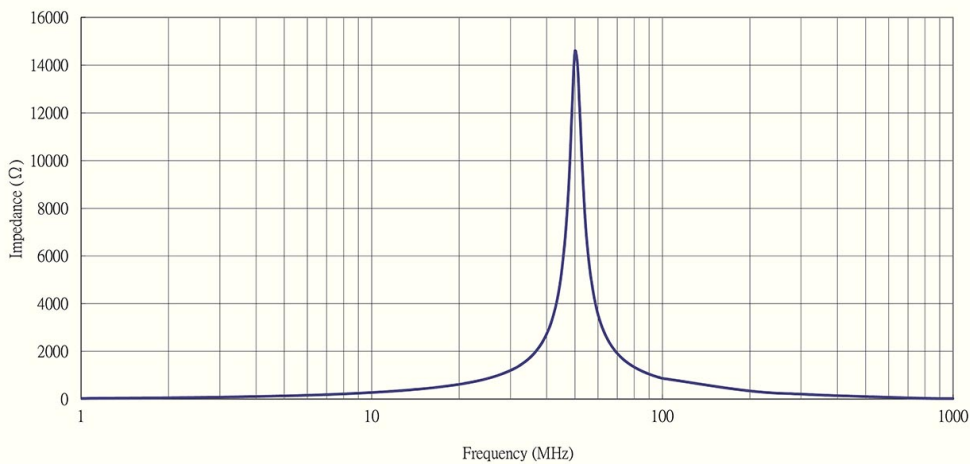

### Impedance Curve



### Outline Dimensions

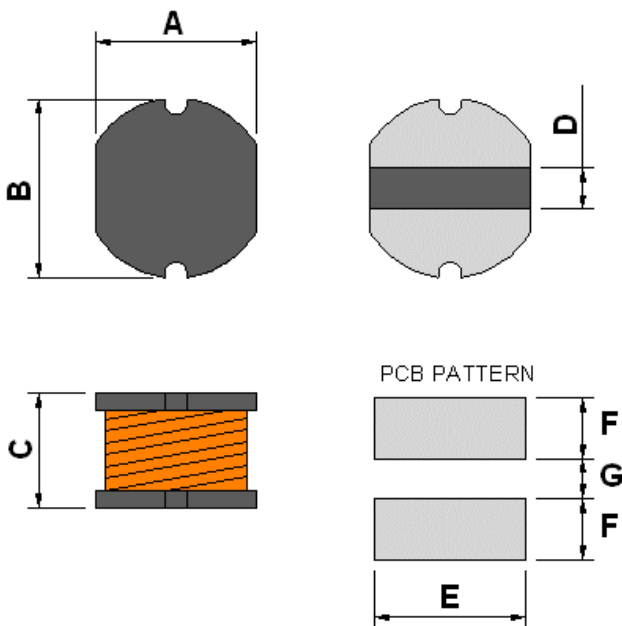

Dimensions [mm]	
<b>A</b>	4.0 $\pm$ 0.5
<b>B</b>	4.5 $\pm$ 0.5
<b>C</b>	3.2 $\pm$ 0.5
<b>D</b>	1.2 typ.
<b>E</b>	4.5
<b>F</b>	1.75
<b>G</b>	1.5

All specifications valid at +25°C, unless otherwise stated.