

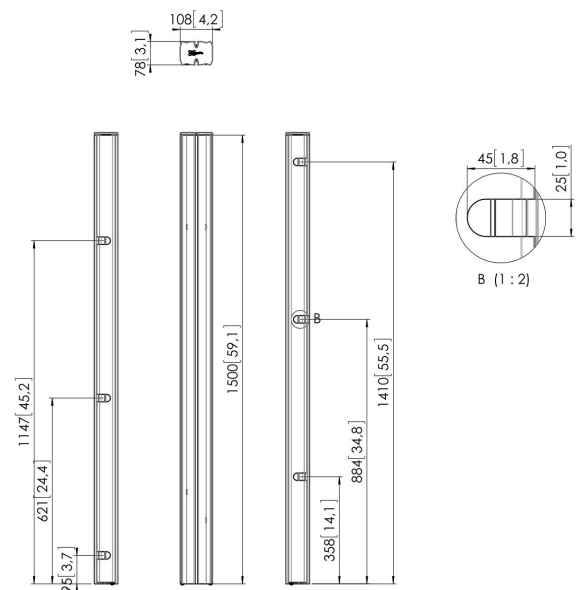

## PUC 2715 Pole 150 cm (silver)

The poles are the connection between the floor base and display interface and are available in 3 different lengths, 150cm, 180cm and 200 cm. The poles are provided with a multiple cable management (CIS®) and can be combined with all Connect-it accessories. The PUC 27xx Series can only be used in combination with the floor solutions.





## PUC 2715 Pole 150 cm (silver)

# Specifications

Article number (SKU)	7227154
Colour	Silver
EAN single box	8712285323645
Length	1500
TÜV certified	Yes
Guarantee	5 years
Back-to-back displays	True
Connect It exceptions	2x if inches gte 65

VOGEL'S HOLDING BV (©)

All rights reserved.  
Subject to printing errors,  
technical and price  
amendments.

Date: 2022-06-01



**Vogel's.** For Sure.