

Specification

Part No.	:	WSA.2458.A.101151
Product Name	:	Phoenix WSA.2458 Dual Band Wi-Fi I-Bar 2.4/5.8GHz Antenna with 1M RG-174 RP-SMA(M)
Feature	:	Wi-Fi/WLAN Adhesive Mount Antenna 1m RG-174 cable with RP-SMA(M) connector Low Profile for Ease of Installation Fully Customizable Cable and Connector 105*30*7.7mm RoHS compliant



1. Introduction

The Phoenix WSA.2458 I-Bar antenna is a robust and low profile, dipole antenna operating on both the 2.4/5.8GHz bands for Wi-Fi applications.

The Phoenix has a slim-line design, which allows for covert and convenient installation in any application, while its omnidirectional radiation pattern and 2.1dBi gain ensure constant reception and transmission. It is manufactured and tested in a TS16949 first tier automotive approved facility and has undergone full PPAP design, reliability and quality audits.

The Phoenix is especially suited for applications such as first-tier automotive applications, aftermarket and telematics.

The Phoenix has exceptional industry performance characteristics considering its very low profile (just 7.7mm) and compact size (105*30mm).

This UV resistant antenna is designed to be mounted on glass or plastic but should not be mounted on a metal base. It comes with strong 3M double-sided adhesive for a permanent and secure fix to your application.

Cable lengths, types and connectors are fully customizable.

2. Specification

Wi-Fi			
Frequency		2400~2500MHz	4900~5850MHz
Efficiency (%)			
In free space	0.3m	68.23	47.03
	1m	54.10	33.08
	2m	38.61	20.16
	3m	27.62	12.13
	5m	14.32	4.45
On glass	0.3m	70.19	40.72
	1m	55.64	28.64
	2m	39.72	17.47
	3m	28.42	10.51
	5m	14.73	3.86
On the 2mm ABS	0.3m	69.94	46.77
	1m	55.43	32.90
	2m	39.58	20.05
	3m	28.31	12.06
	5m	14.67	4.43
Average Gain(dBi)			
In free space	0.3m	-1.66	-3.30
	1m	-2.67	-4.84
	2m	-4.13	-7.00
	3m	-5.59	-9.22
	5m	-8.44	-13.59
On glass	0.3m	-1.54	-3.94
	1m	-2.55	-5.48
	2m	-4.01	-7.64
	3m	-5.46	-9.86
	5m	-8.32	-14.23
On the 2mm ABS	0.3m	-1.55	-3.33
	1m	-2.56	-4.86
	2m	-4.03	-7.02
	3m	-5.48	-9.24
	5m	-8.33	-13.62

Peak Gain(dBi)			
In free space	0.3m	2.65	3.19
	1m	1.55	1.73
	2m	0.15	-0.31
	3m	-1.35	-2.41
	5m	-4.25	-6.61
On glass	0.3m	3.98	4.22
	1m	2.89	2.72
	2m	1.48	0.62
	3m	-0.02	-1.58
	5m	-2.89	-5.88
On the 2mm ABS	0.3m	2.95	4.31
	1m	1.89	2.81
	2m	0.45	0.81
	3m	-1.05	-1.29
	5m	-3.91	-5.49
Return loss	< -10 dB		
VSWR	≤ 2:1		
Impedance	50Ω		
Polarization	Linear		
Radiation Pattern	Omnidirectional		
Input Power	2W		
MECHANICAL			
Dimensions	105*30*7.7mm		
Casing	PC/ABS		
Connector	RP-SMA(M)		
Cable	RG-174		
Weight	50g		
ENVIRONMENTAL			
Temperature Range	-40°C to 85°C		

3. Antenna Characteristics

3.1 Antenna Test Setup

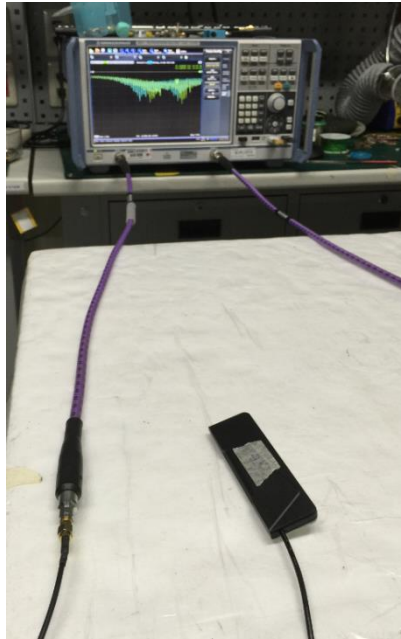

Free Space

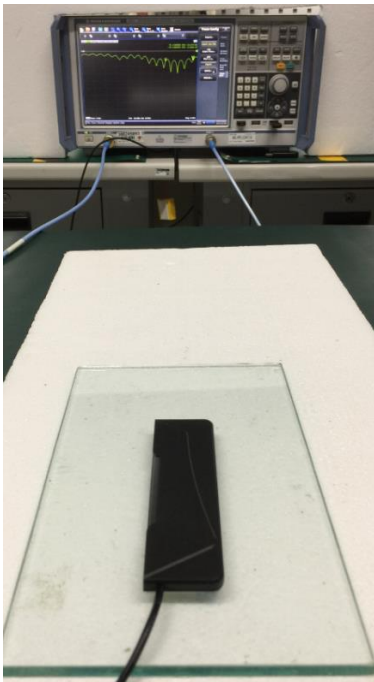

On Glass

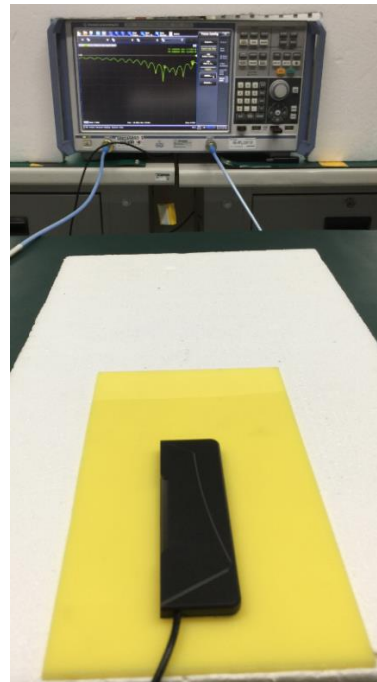

On 2mm ABS



3.2 Return Loss

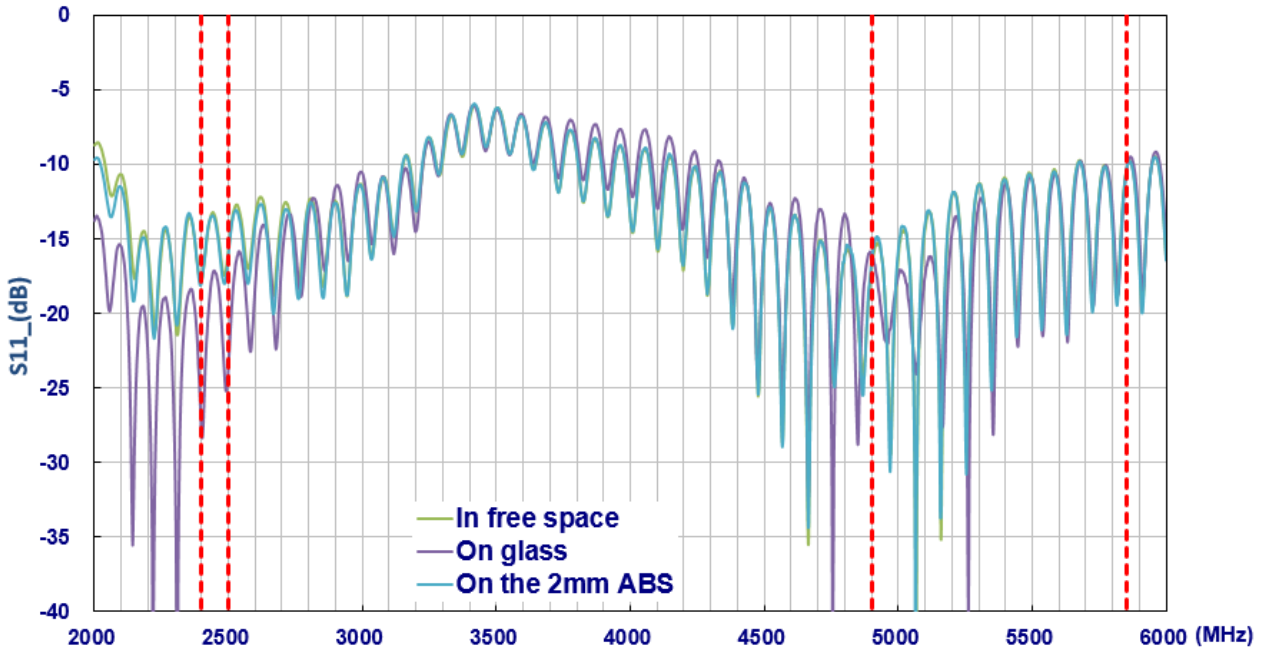

3.3 Efficiency

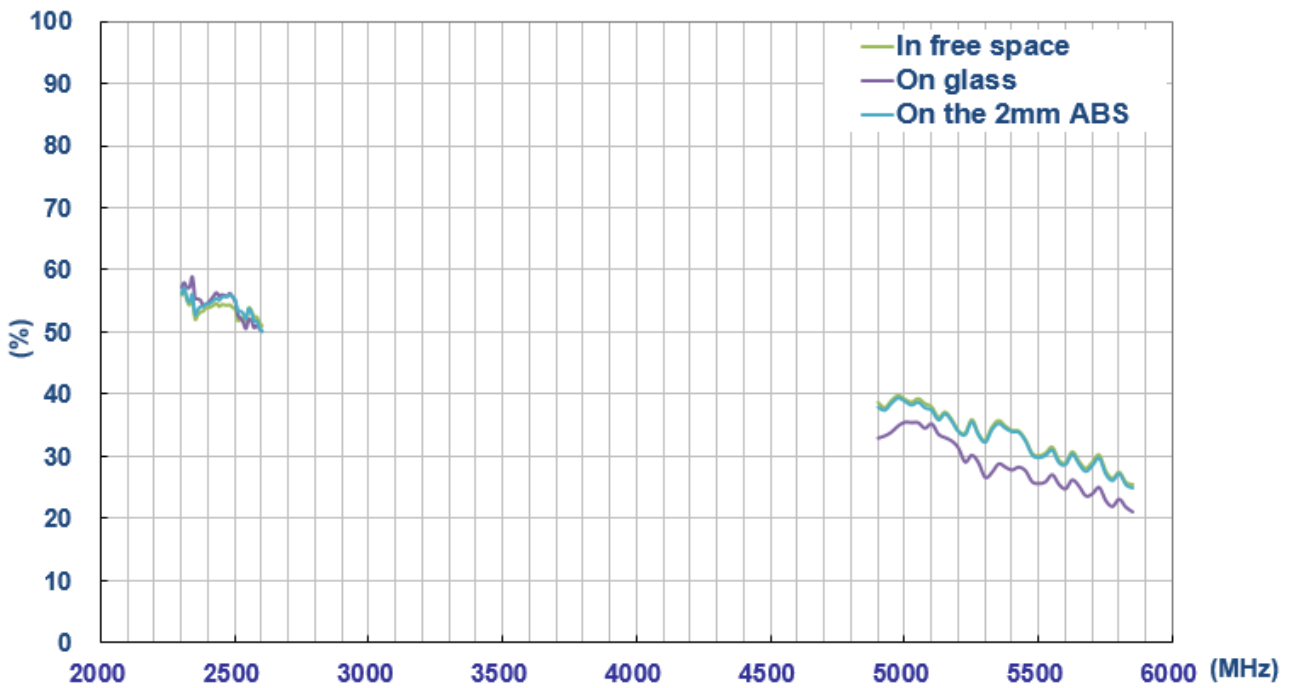



3.4 Peak Gain

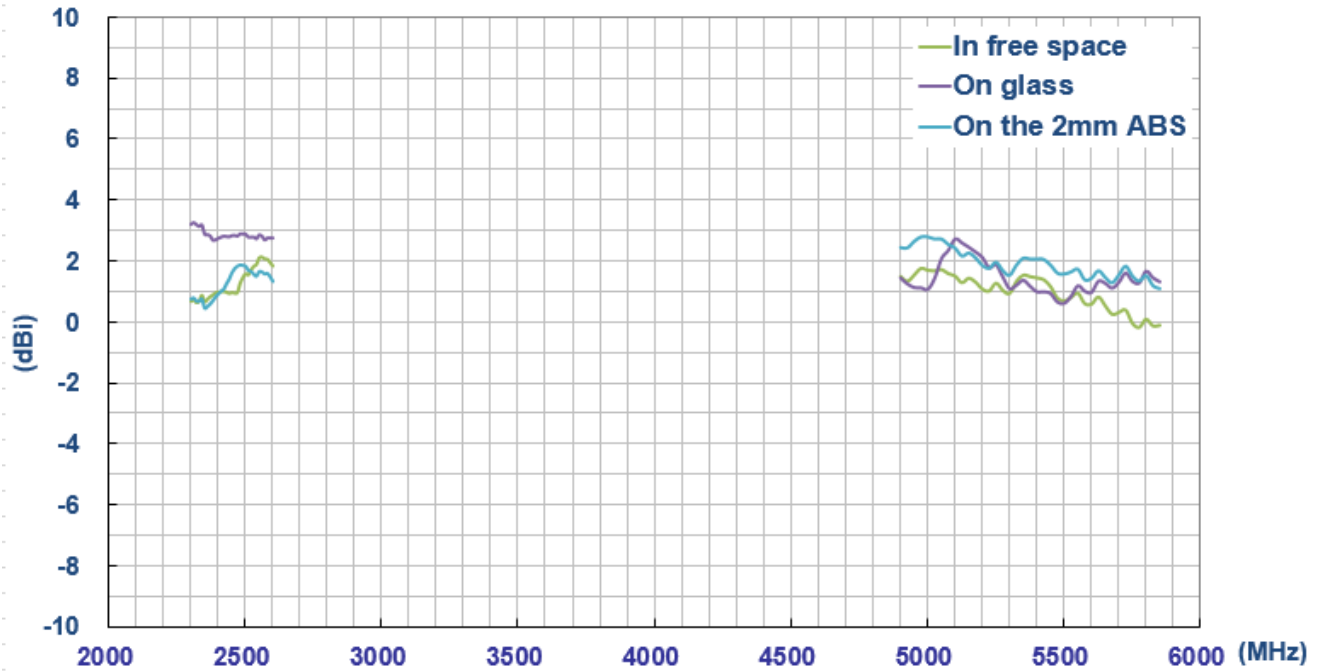

3.5 Average Gain

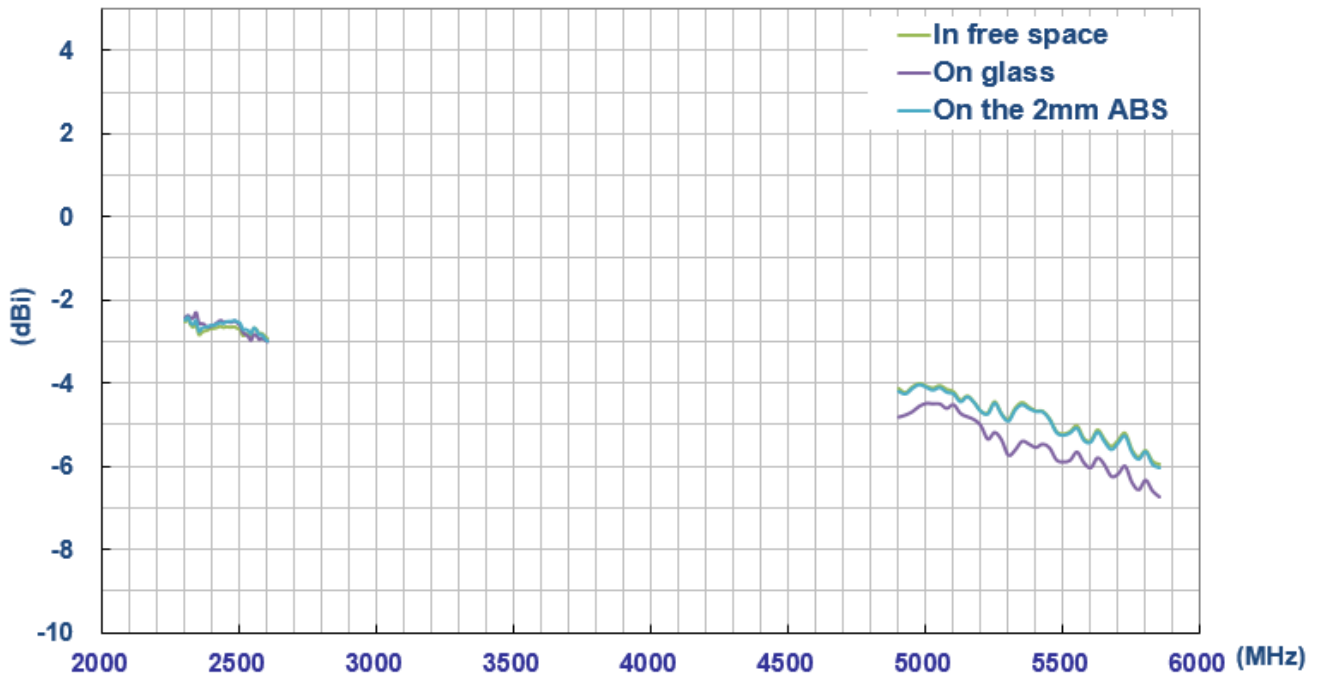

4 Antenna Radiation Patterns

4.1 Antenna setup (Free space with 1 meter cable length)

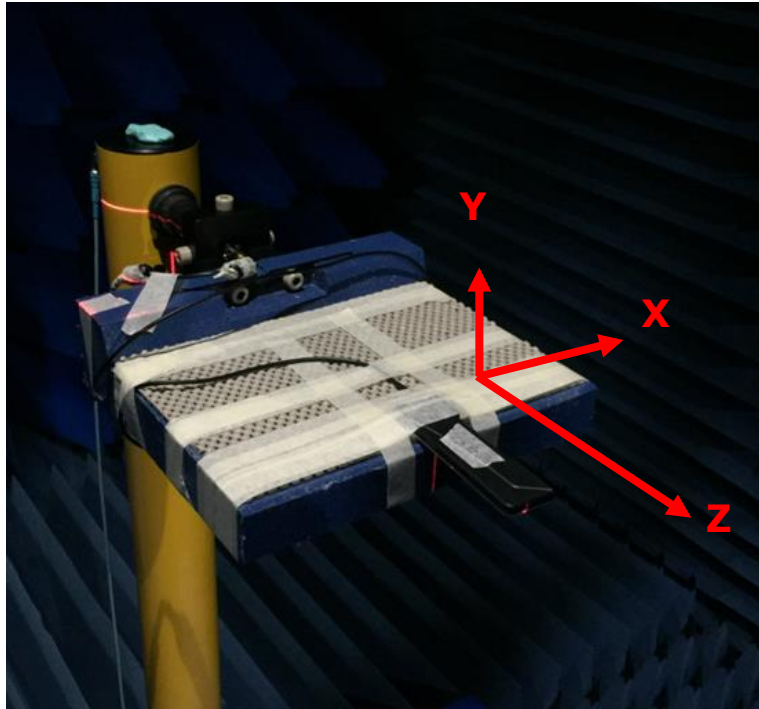

Free Space

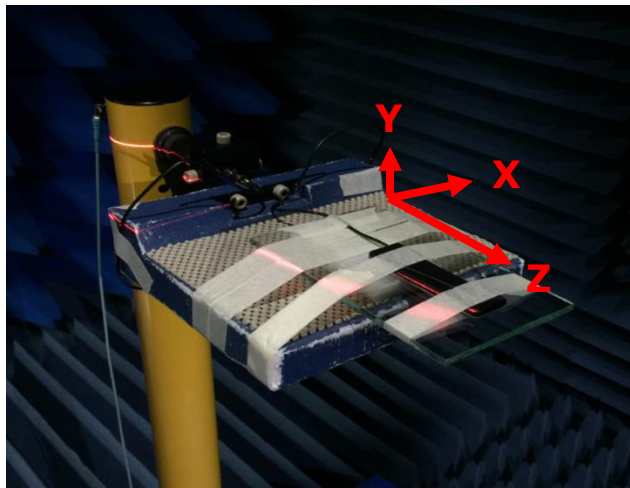

On Glass

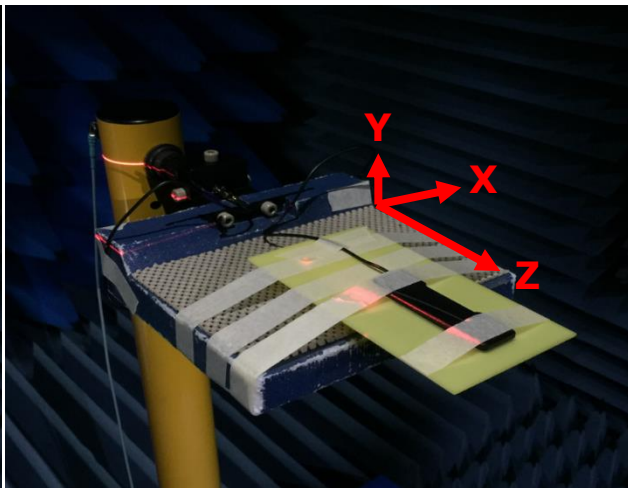

On 2mm ABS

Antenna testing Setup in ETS Anechoic Chamber



4.2 2D Radiation Patterns

4.2.1 Free Space

XY Plane

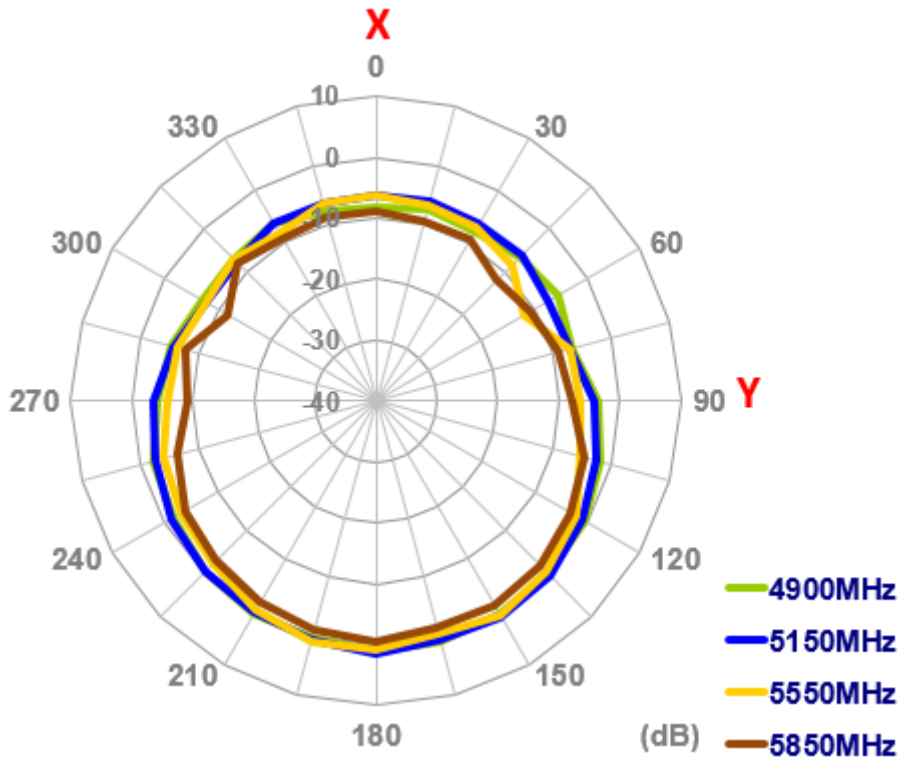
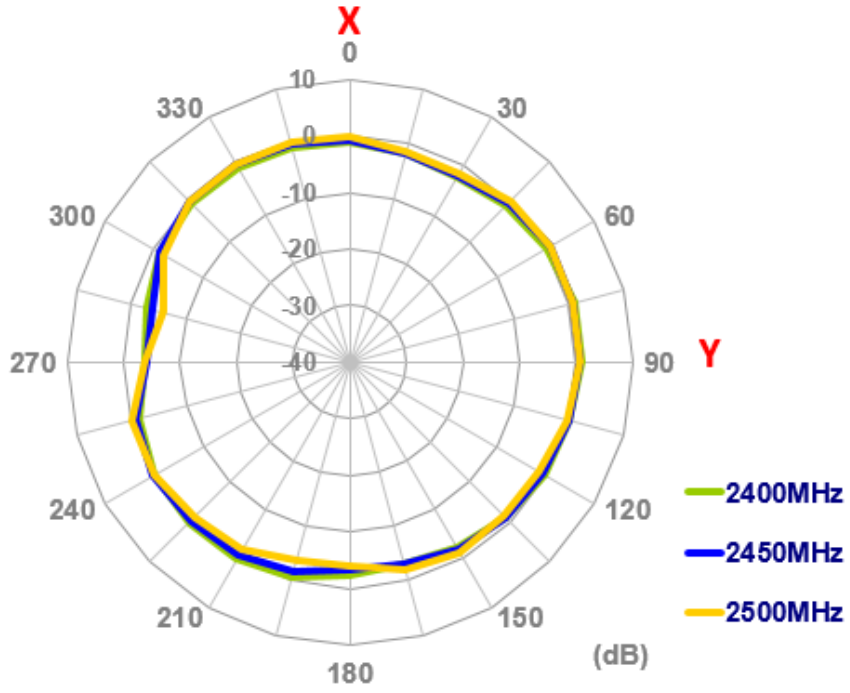



TAOGLAS®

XZ Plane

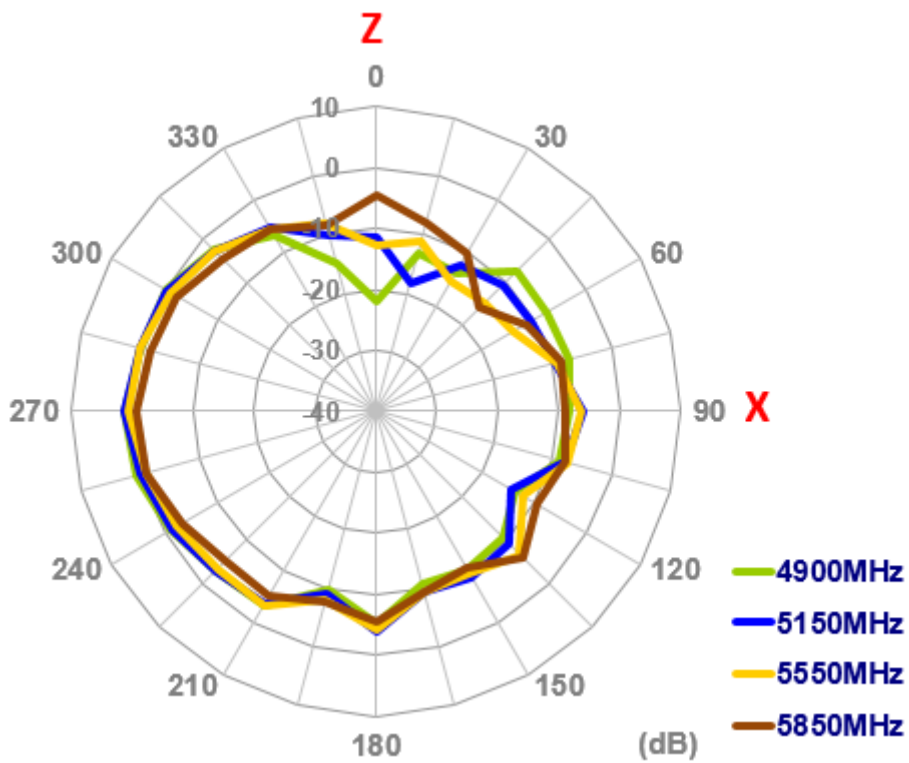
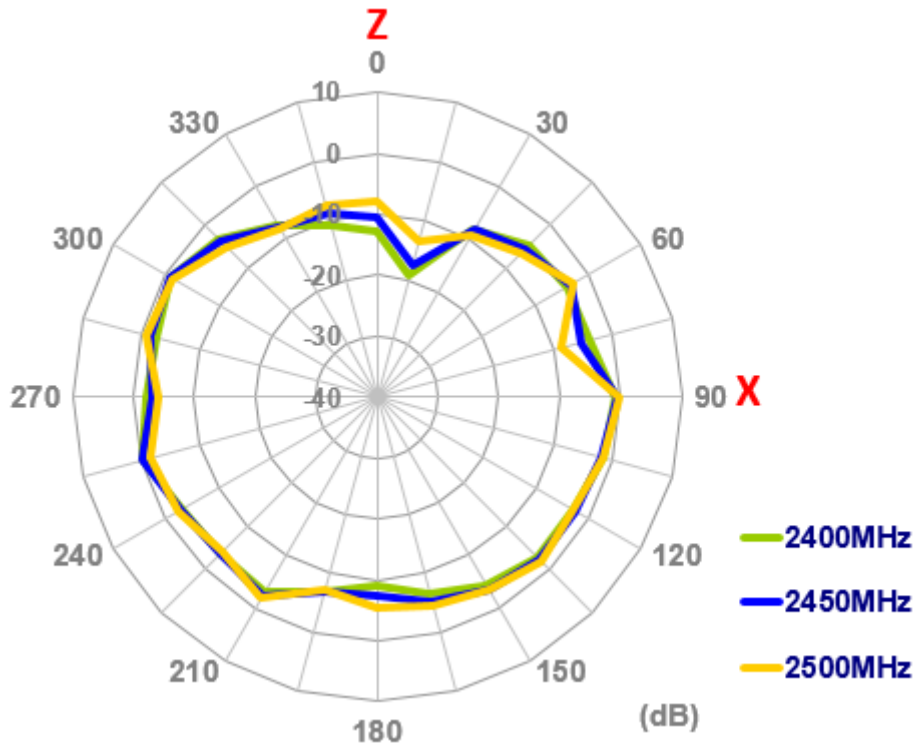



YZ Plane

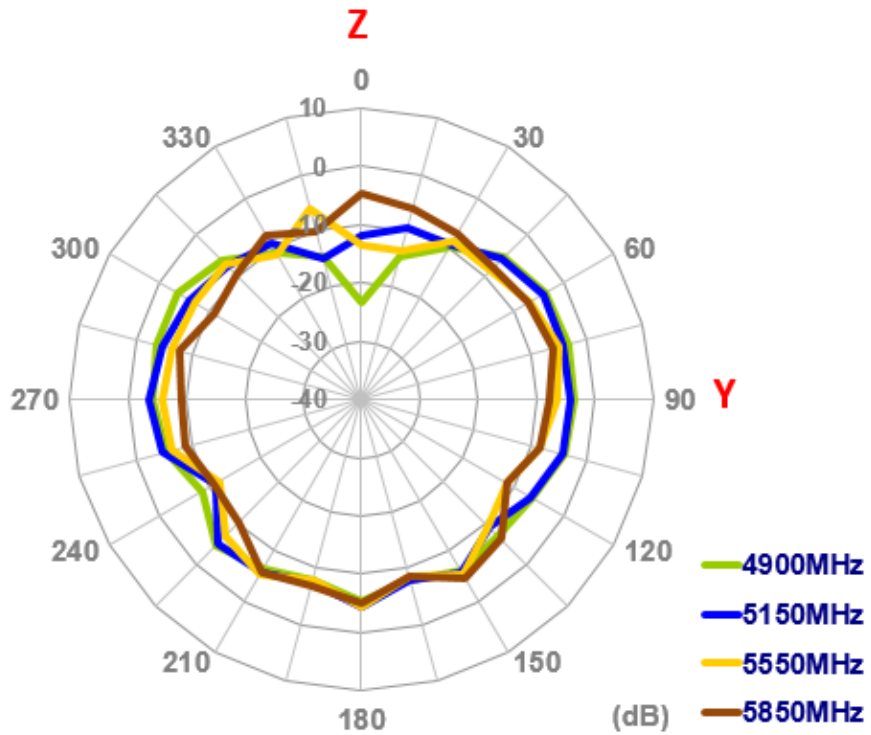
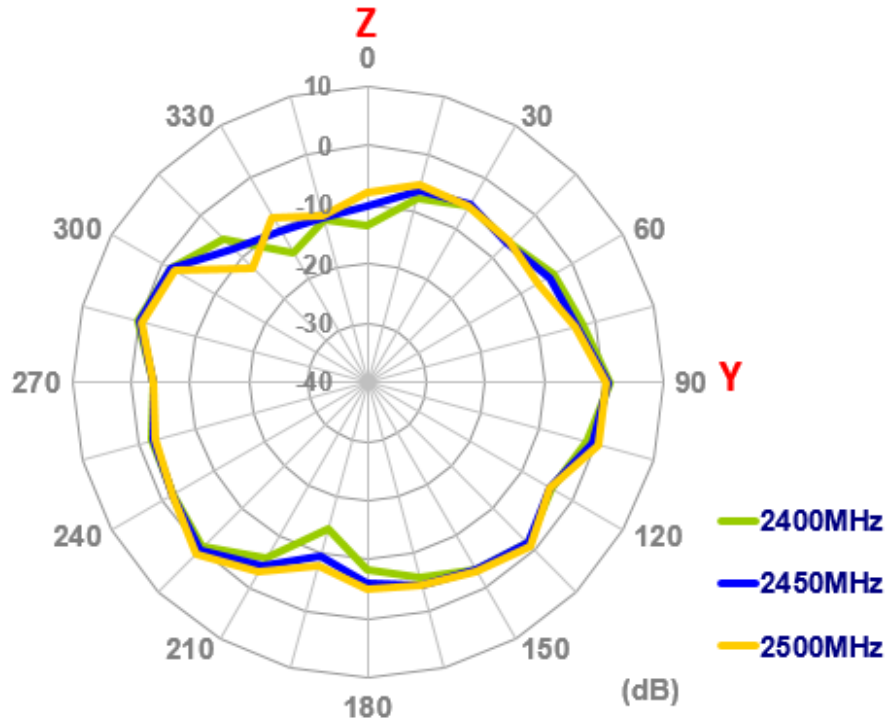



4.2.2 On Glass

XY Plane

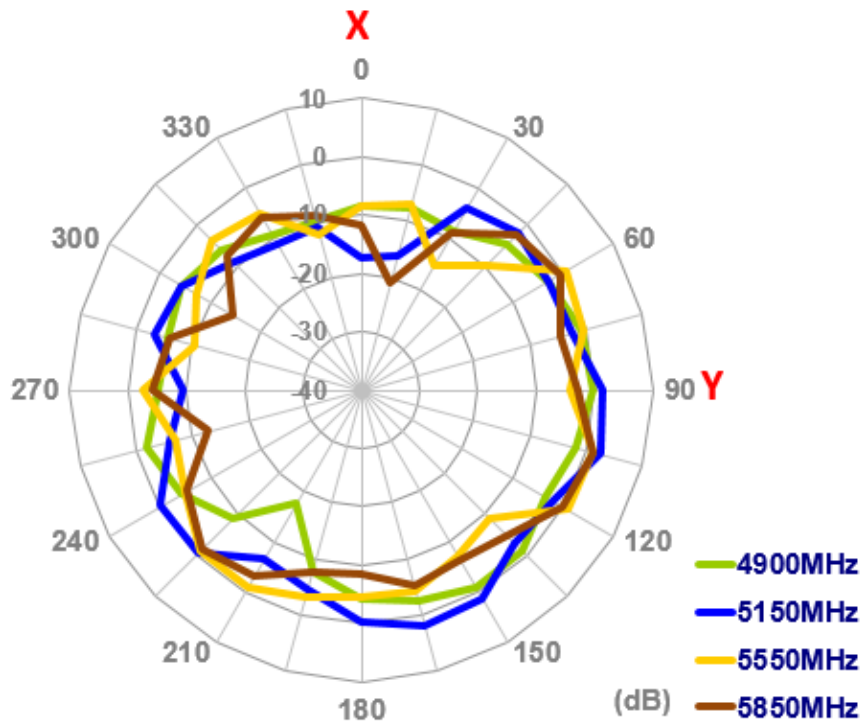
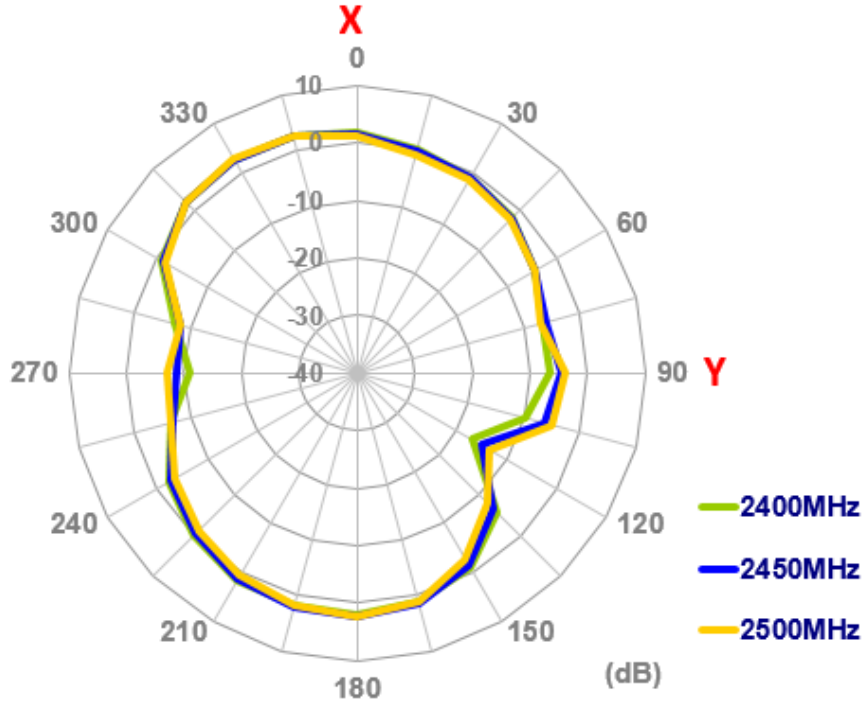



XZ Plane

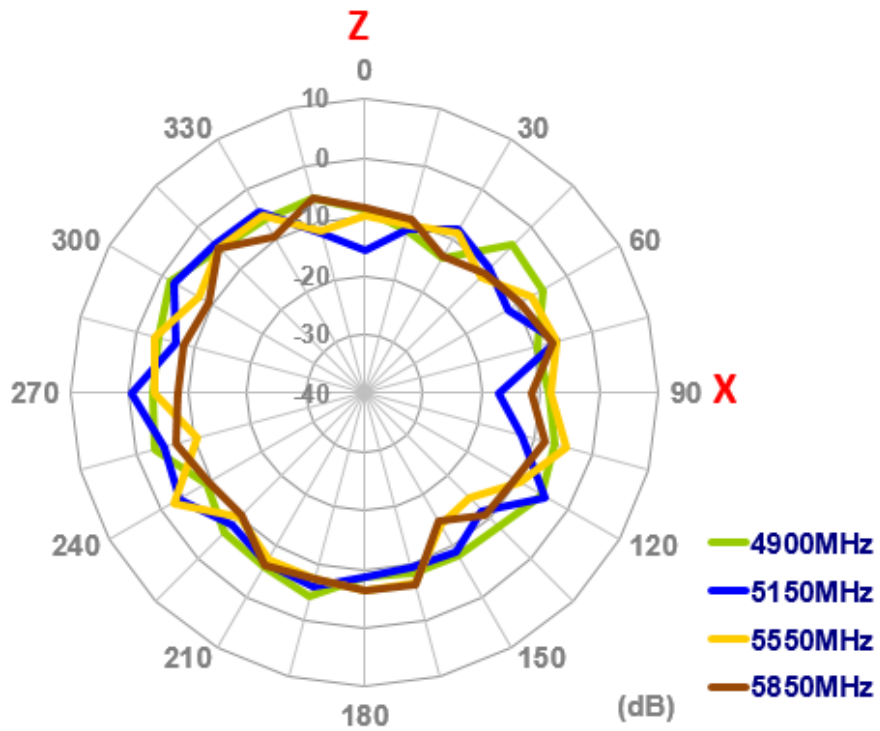
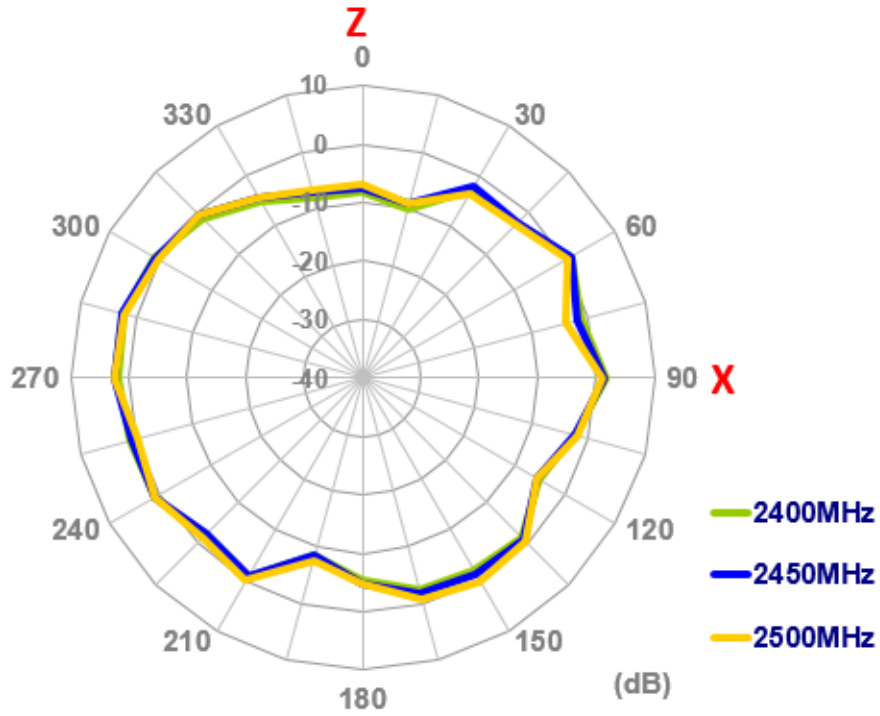



TAOGLAS®

YZ Plane

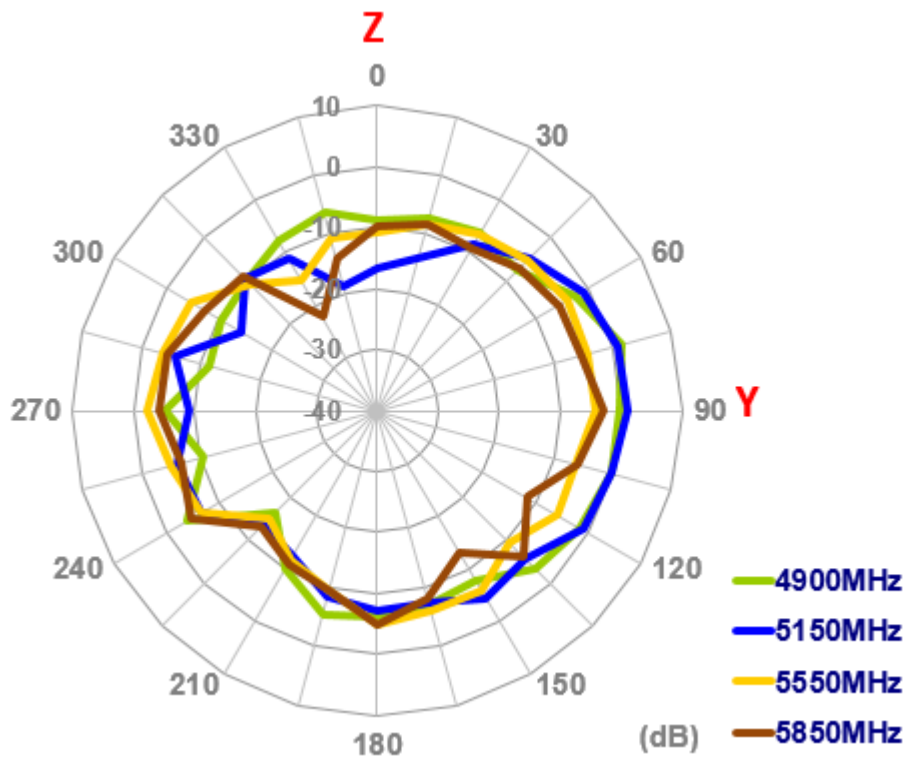
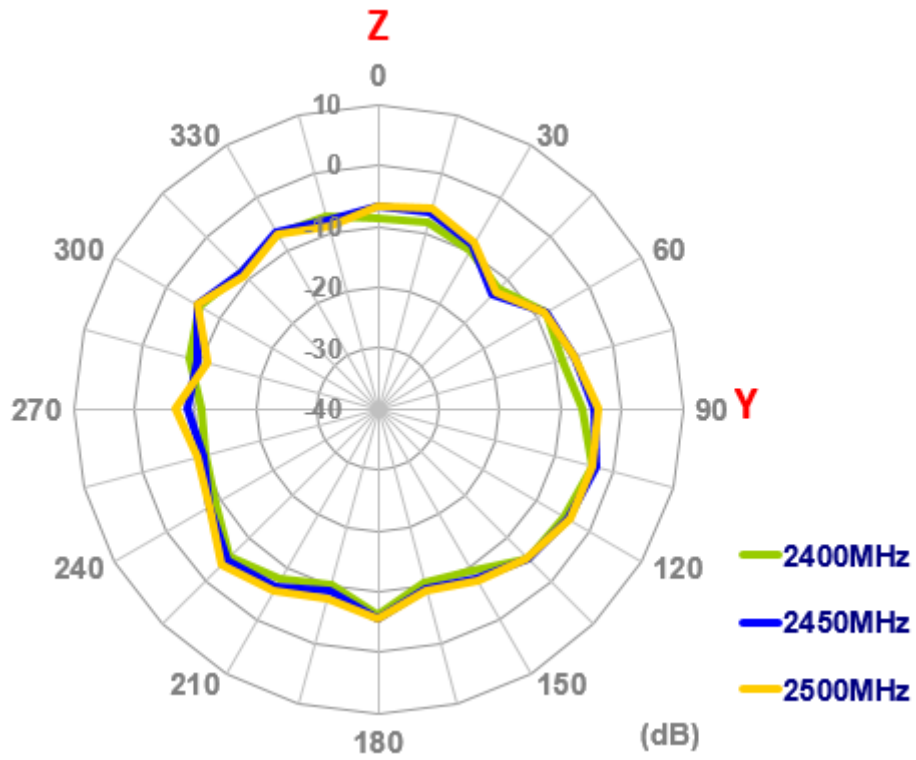



4.2.3 On 2mm ABS

XY Plane

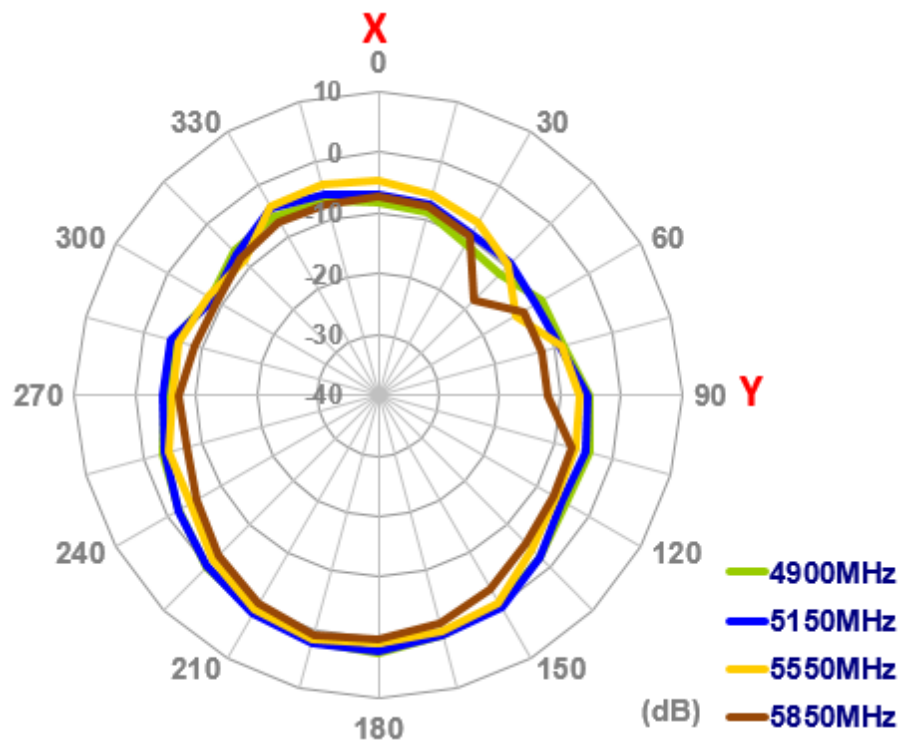
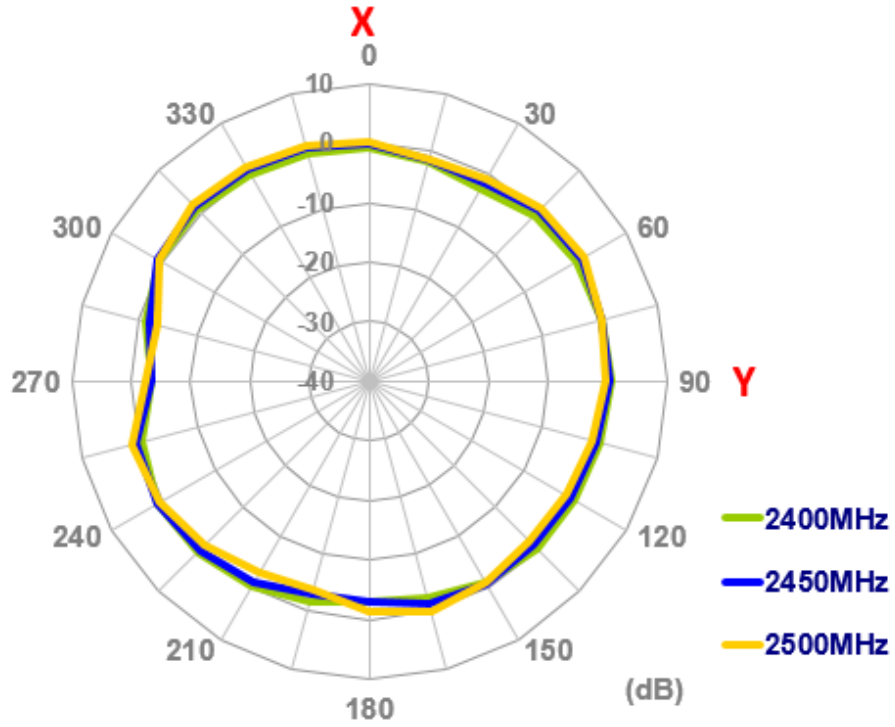



XZ Plane

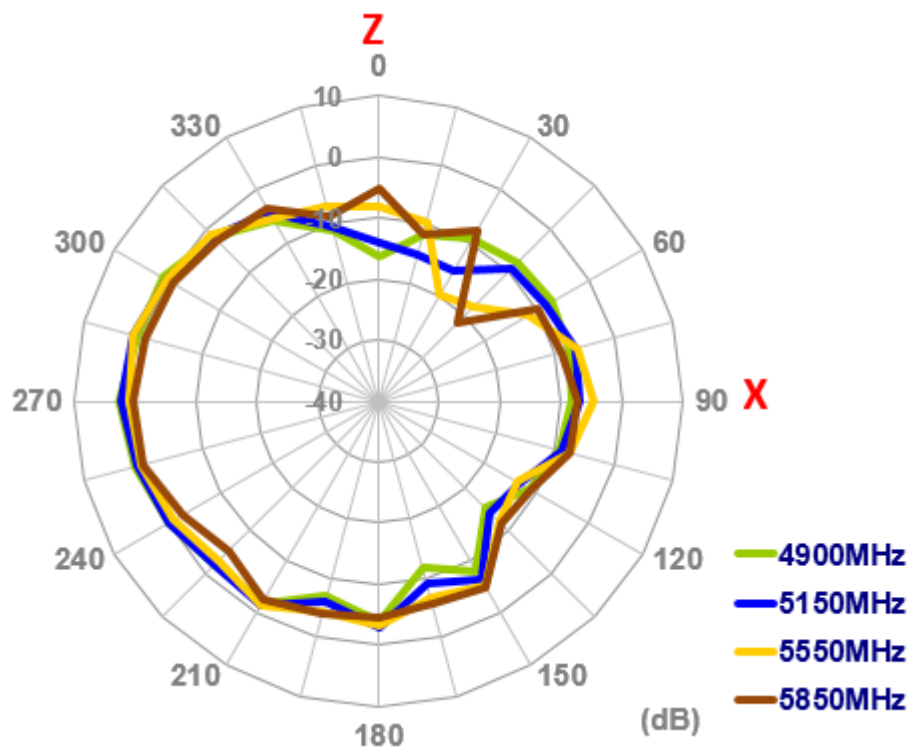
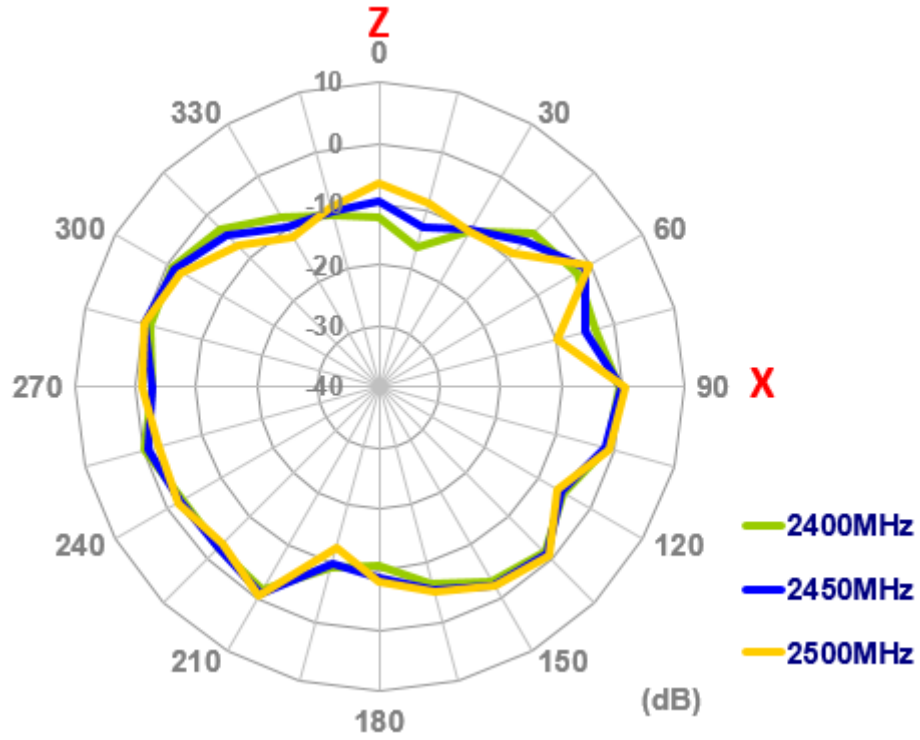



YZ Plane

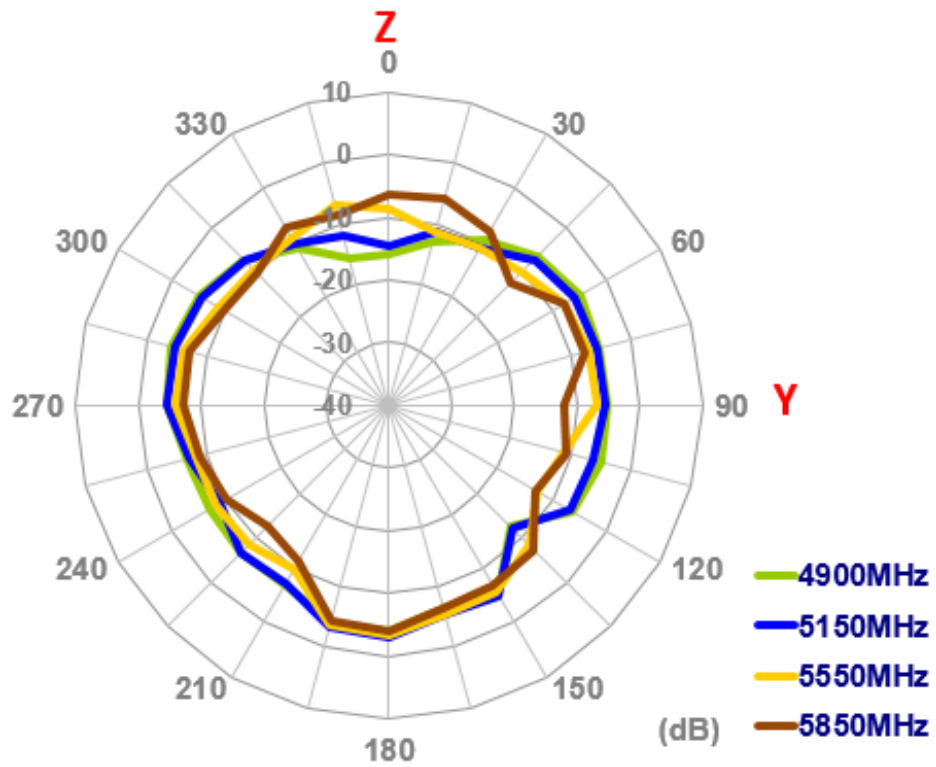
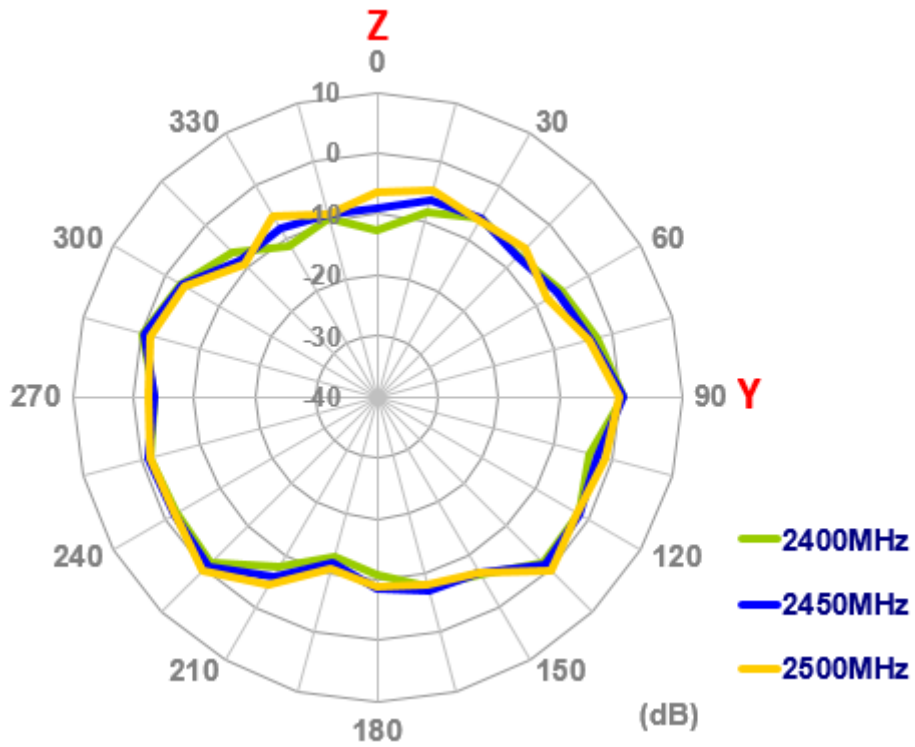



4.3 Antenna 3D Radiation Pattern

4.3.1 Free Space

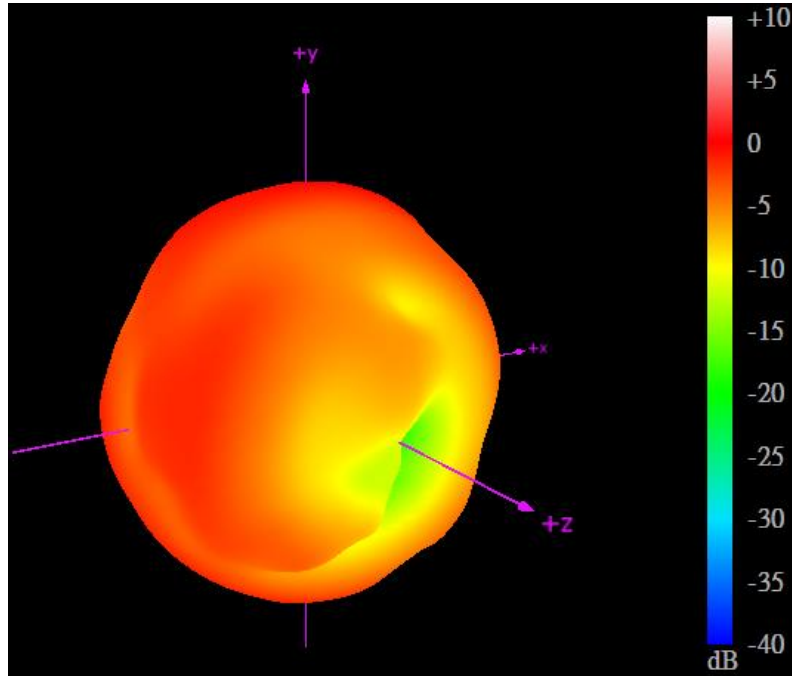

2450MHz

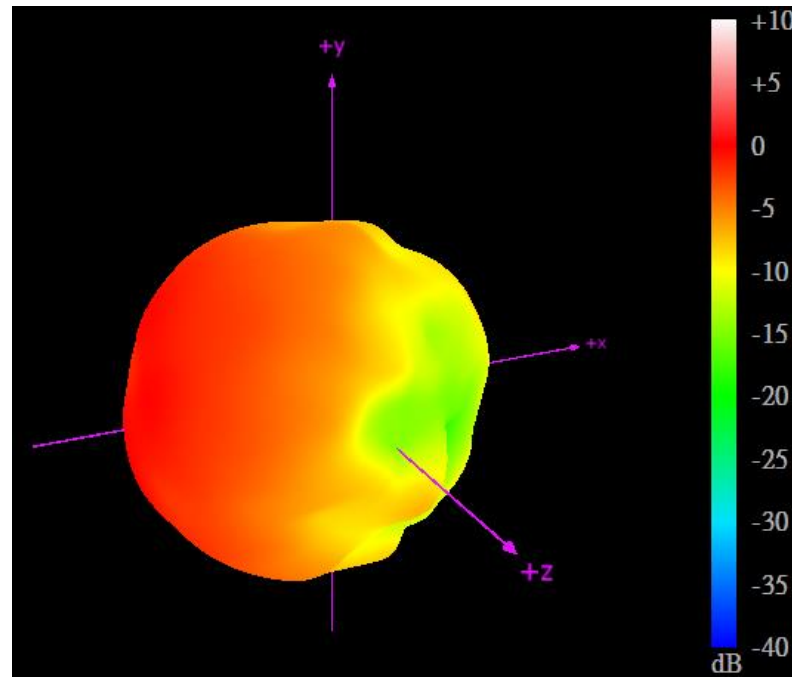

5550MHz



4.3.2 On Glass

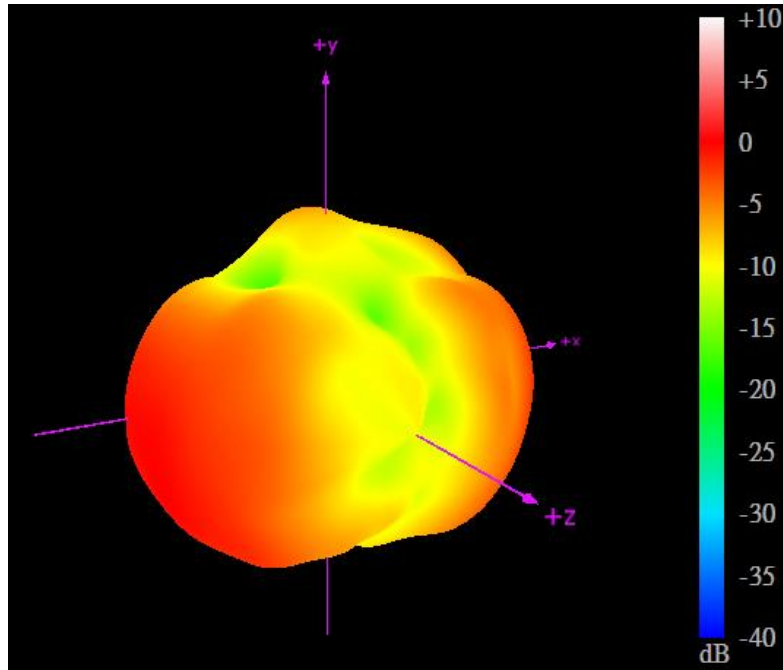

2450MHz

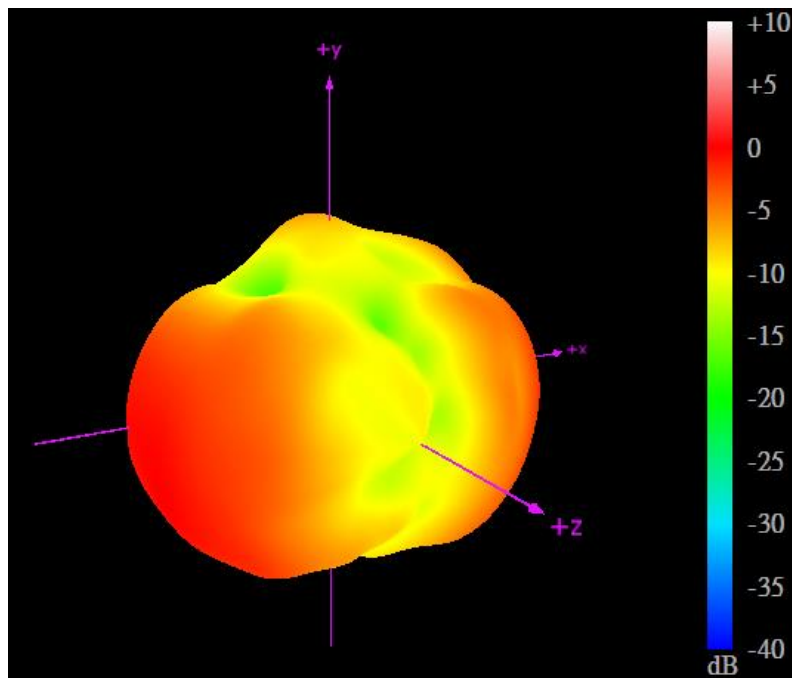

5550MHz



4.3.3 On 2mm ABS

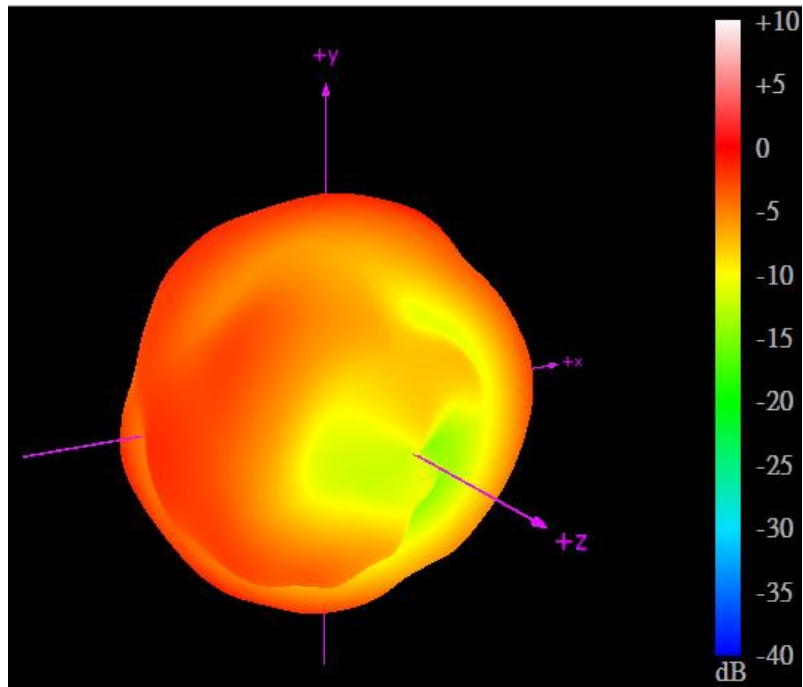

2450MHz

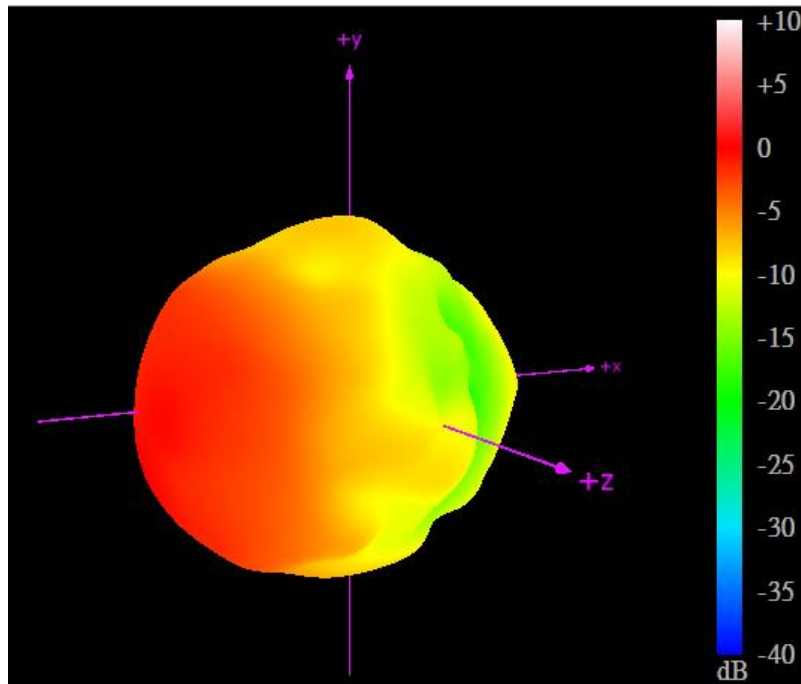

5550MHz



5 Drawing (Unit: mm)

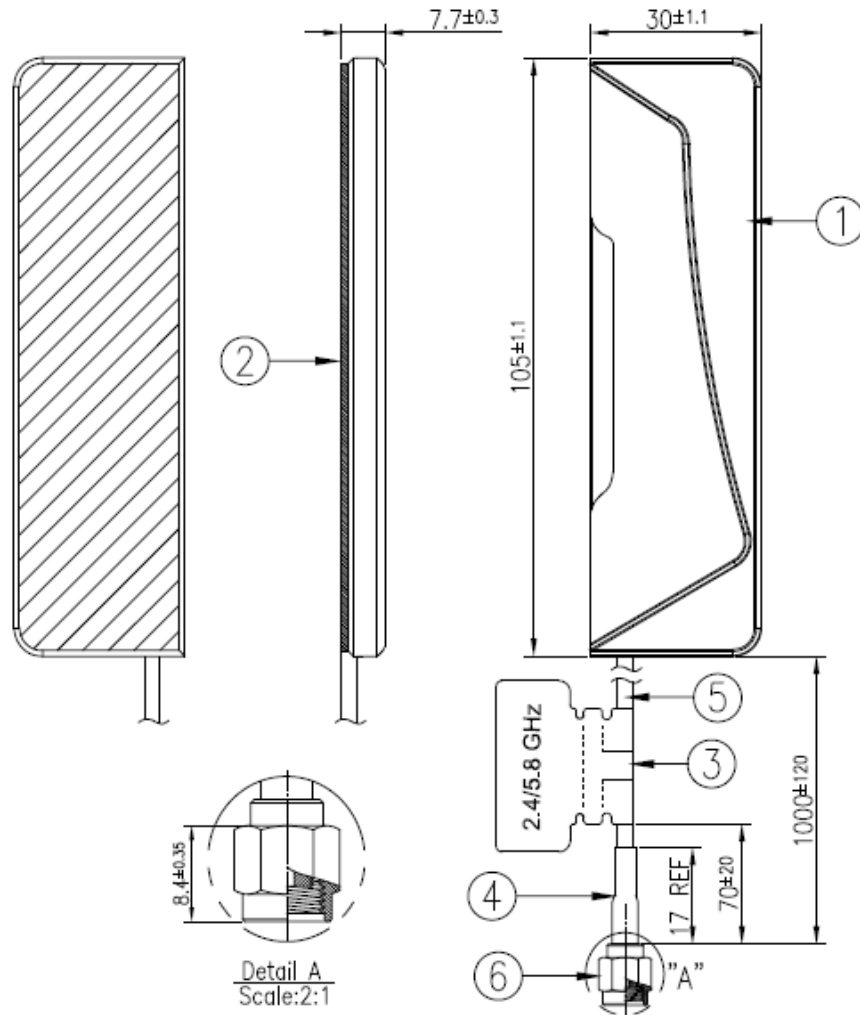

	Name	P/N	Material	Finish	QTY
1	Housing	000112G000015A	PC+ABS	Black	1
2	Double Sided Adhesive	001011J000015A	3M 1600T	Blue Liner	1
3	2.4/5.8 GHz Label	001016G070000A	PEPA	Teal Green	1
4	Heat Shrink Tube	001315C020000A	PE	Black	1
5	RG174 Coaxial Cable	301315C000000A	PVC	Black	1
6	RP-SMA(M)	200214E000015A	Brass	Au Plated	1



6 Packaging

WSA.2458.A.101151

Packaging Specifications

1pcs WSA.2458.A.101151 per PE Bag
Bag Dimensions - 190 x 70mm
Weight - 34.5g

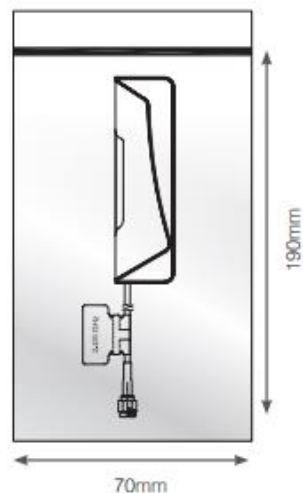

200 pcs WSA.2458.A.101151 per carton
Carton - 400x 330 x 220mm
Weight - 7.1Kg

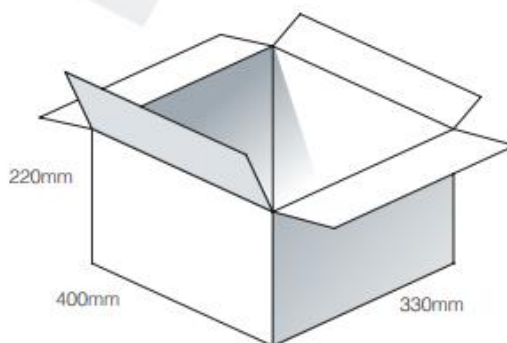

Pallet Dimensions 120 x 110x 150cm
54 Cartons per Pallet
9 Cartons per layer
6 Layers

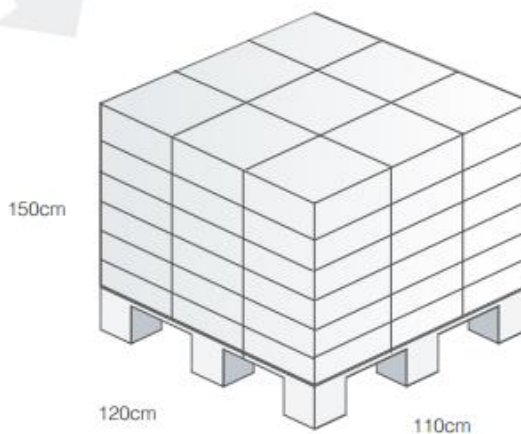



7 Application Note

The WSA.2458 antenna performance with different cable lengths is shown below.

7.1 In free Space

Return Loss

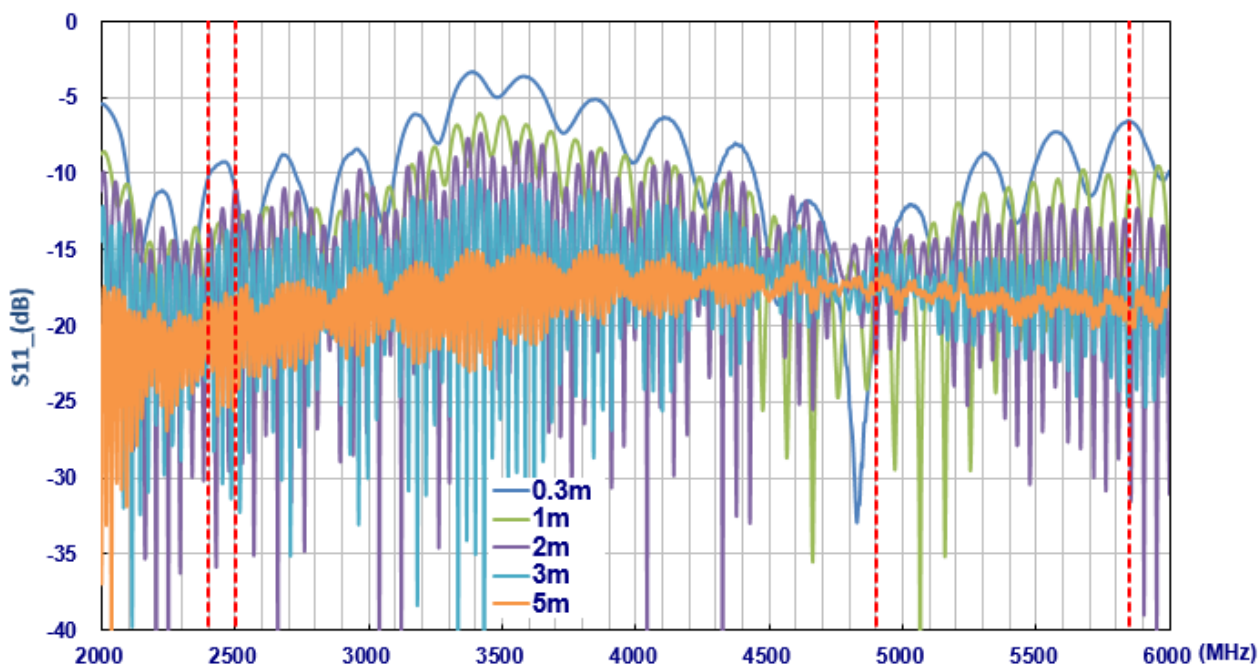

Efficiency

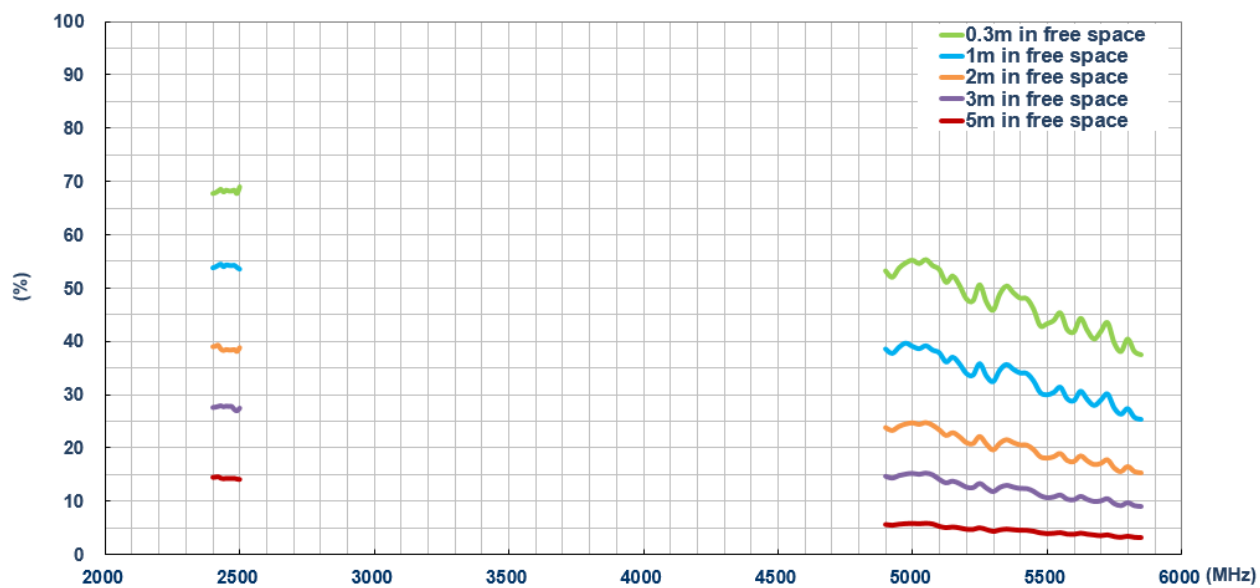



Peak Gain

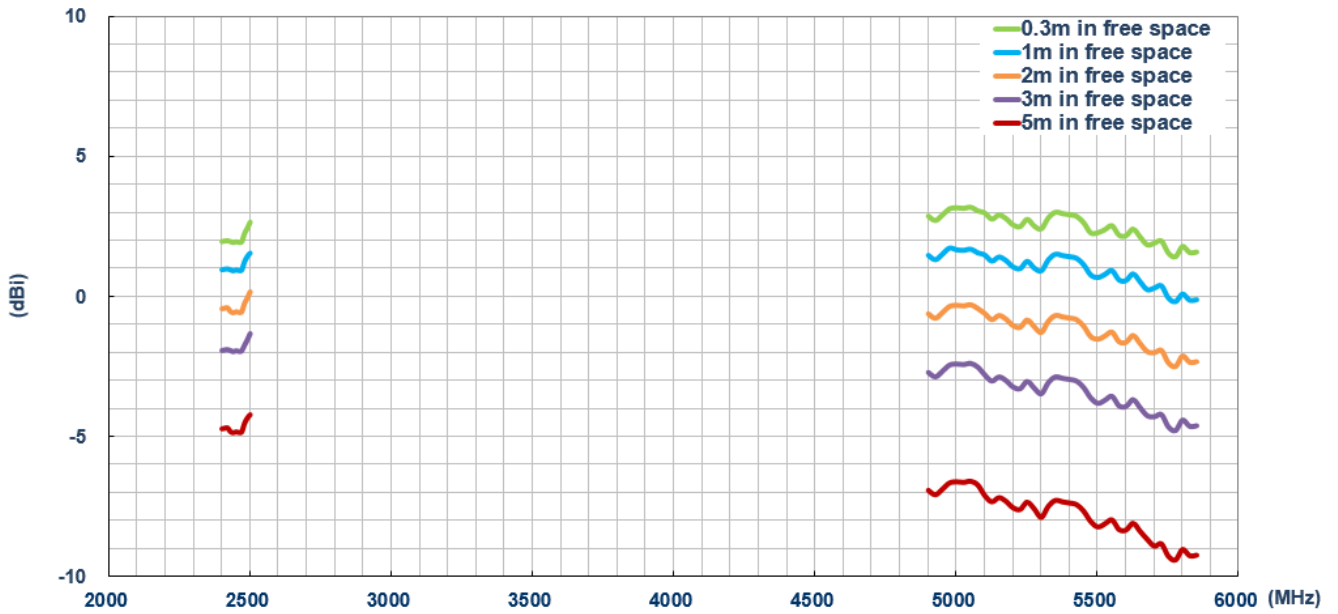

Average Gain

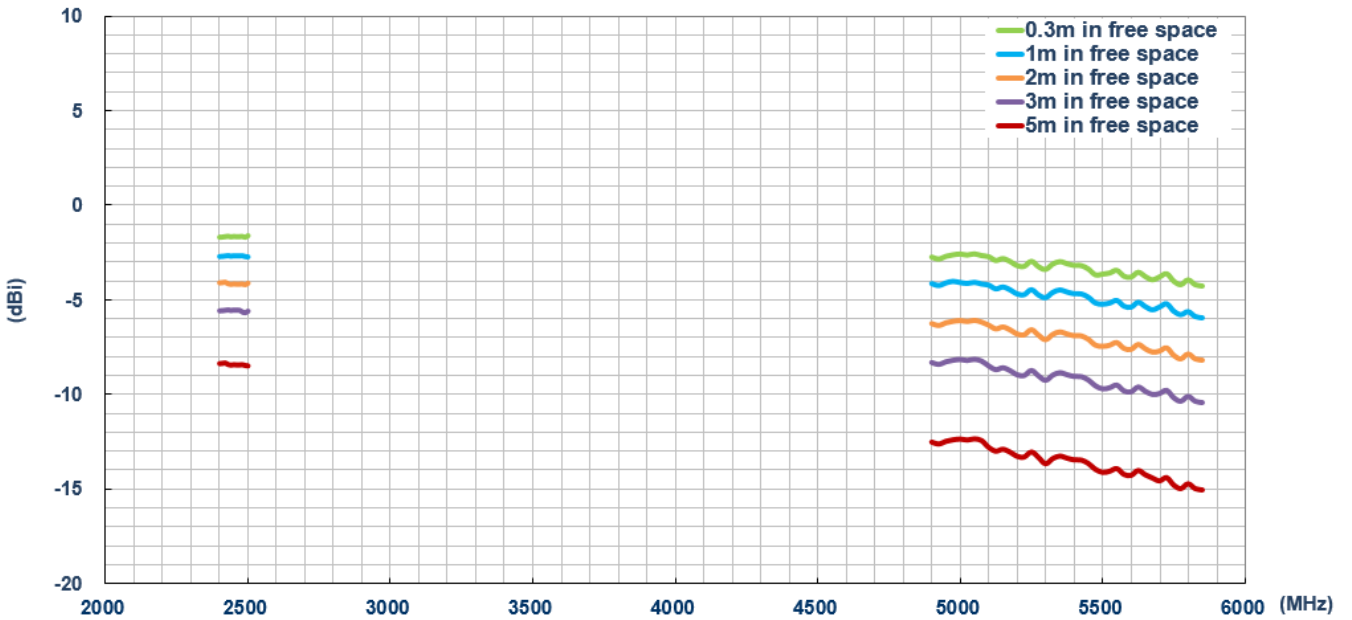



7.2 On Glass

Return Loss

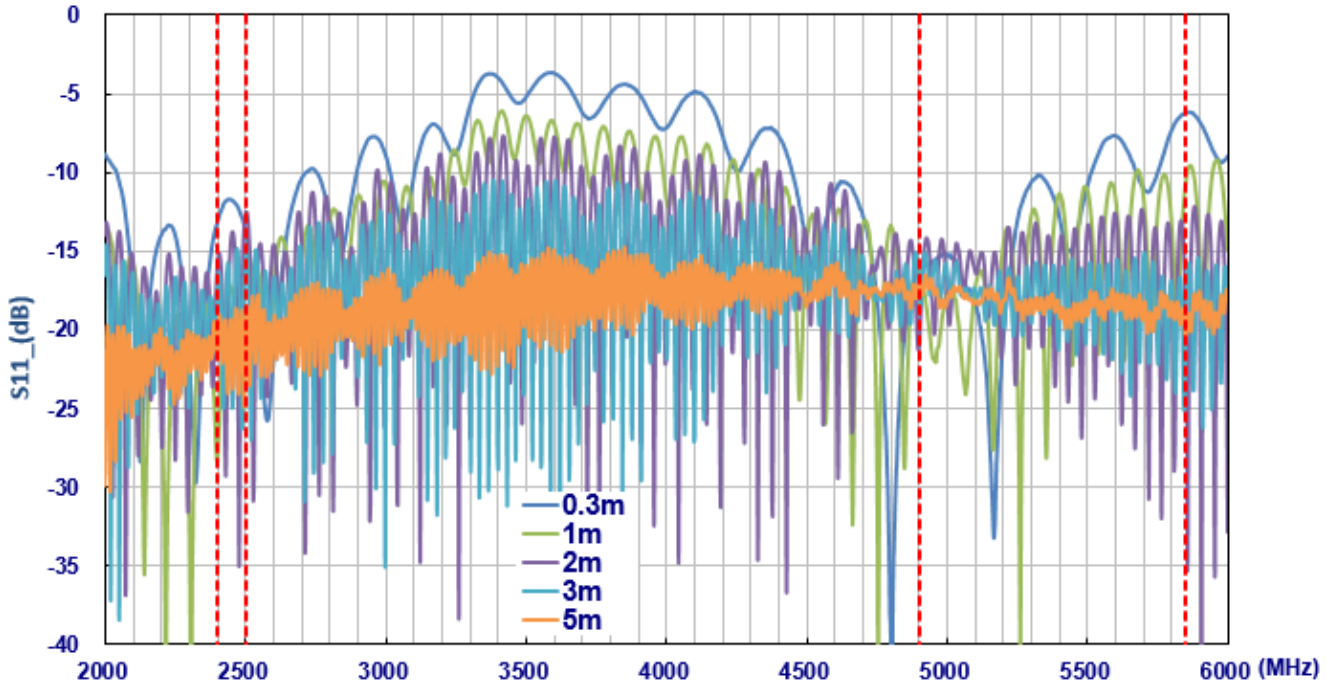

Efficiency

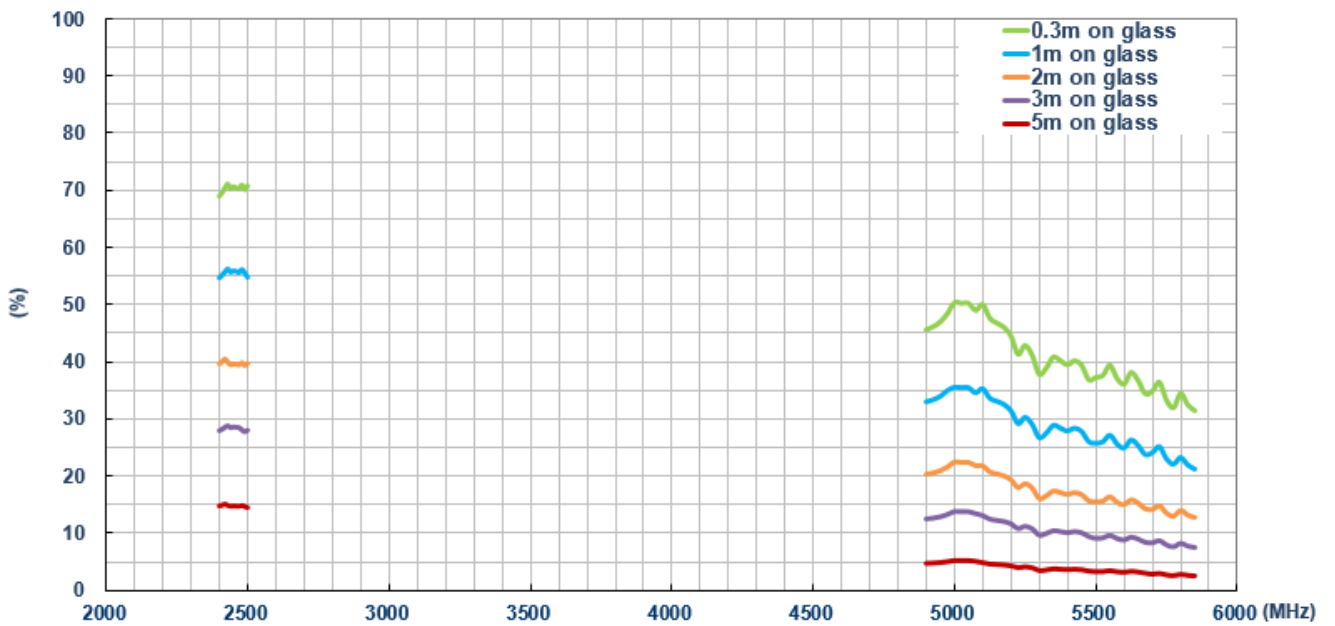



Peak Gain

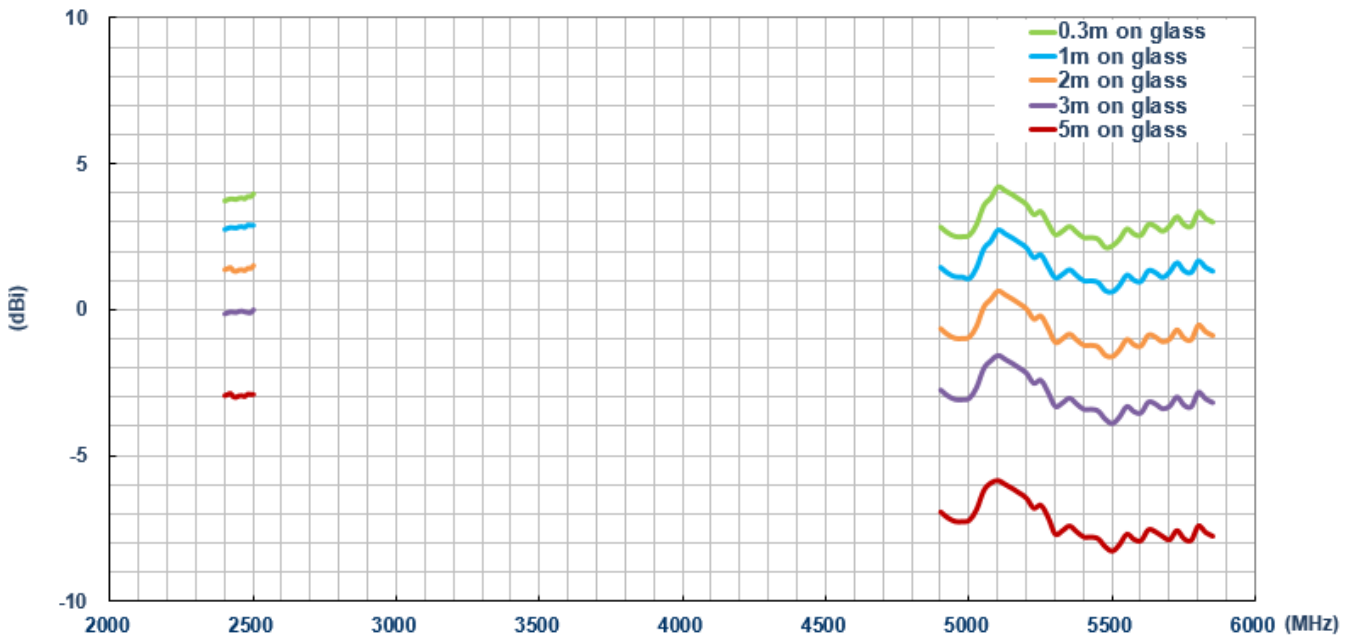

Average Gain

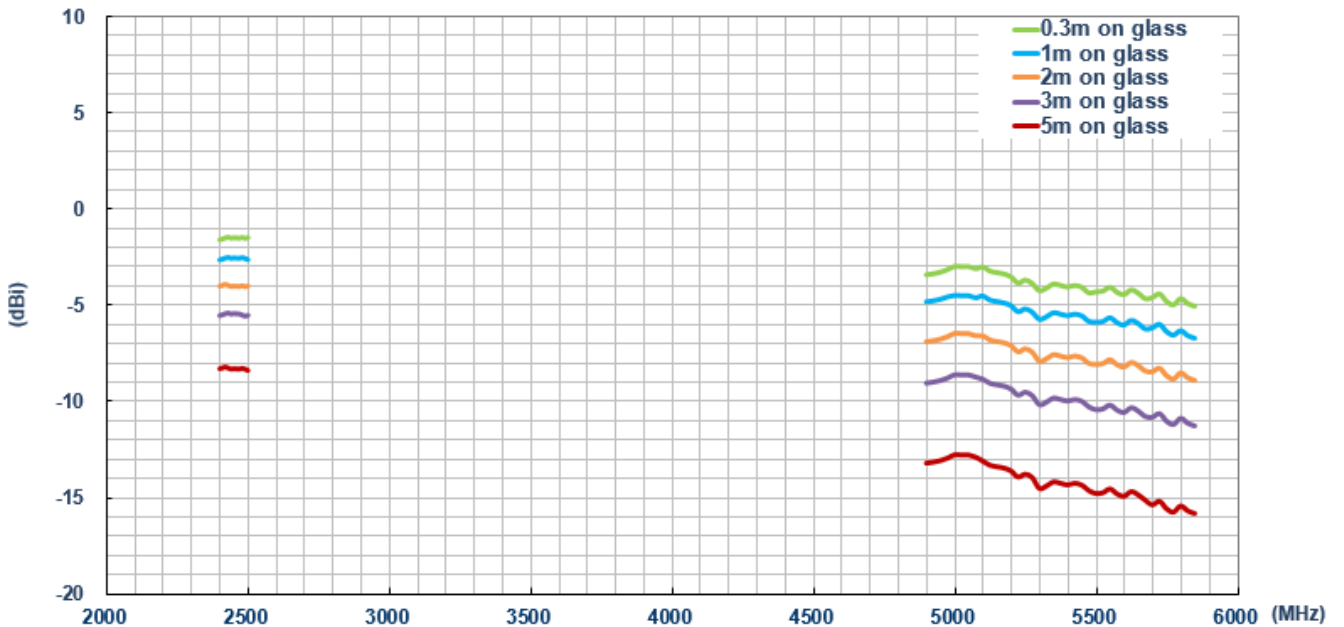



7.3 On 2mm ABS

Return Loss

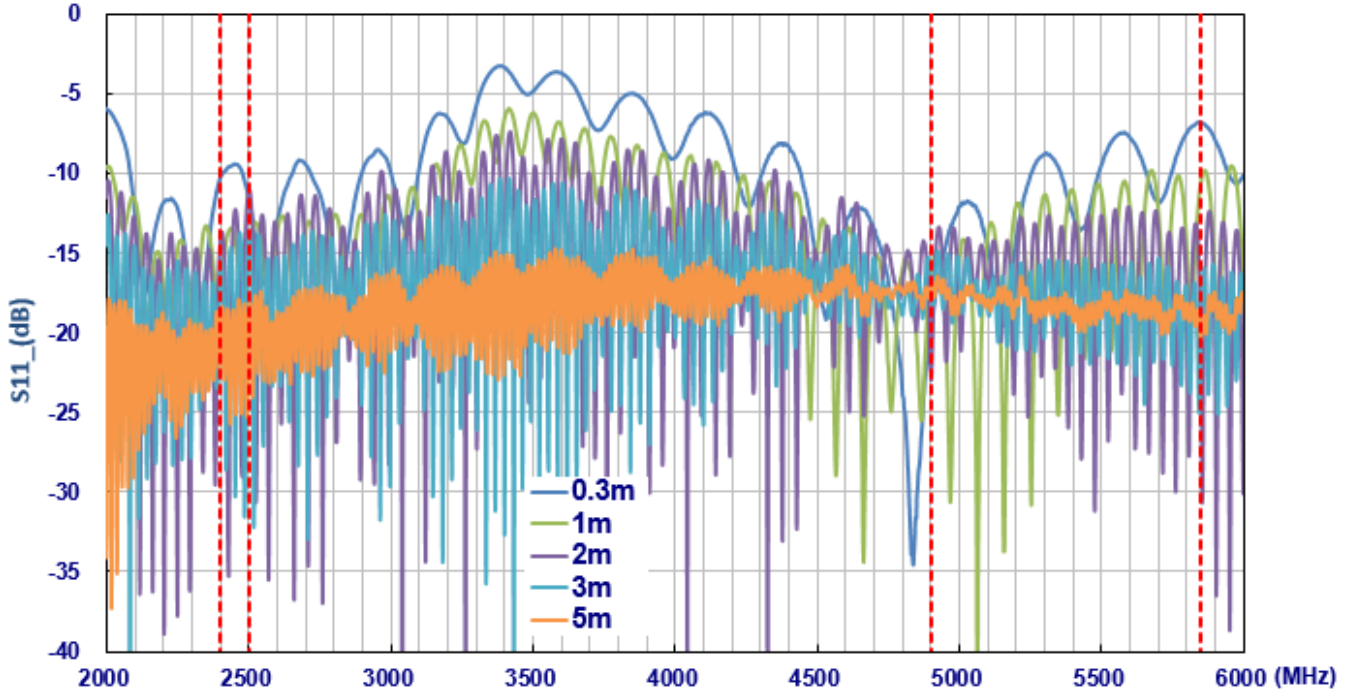

Efficiency

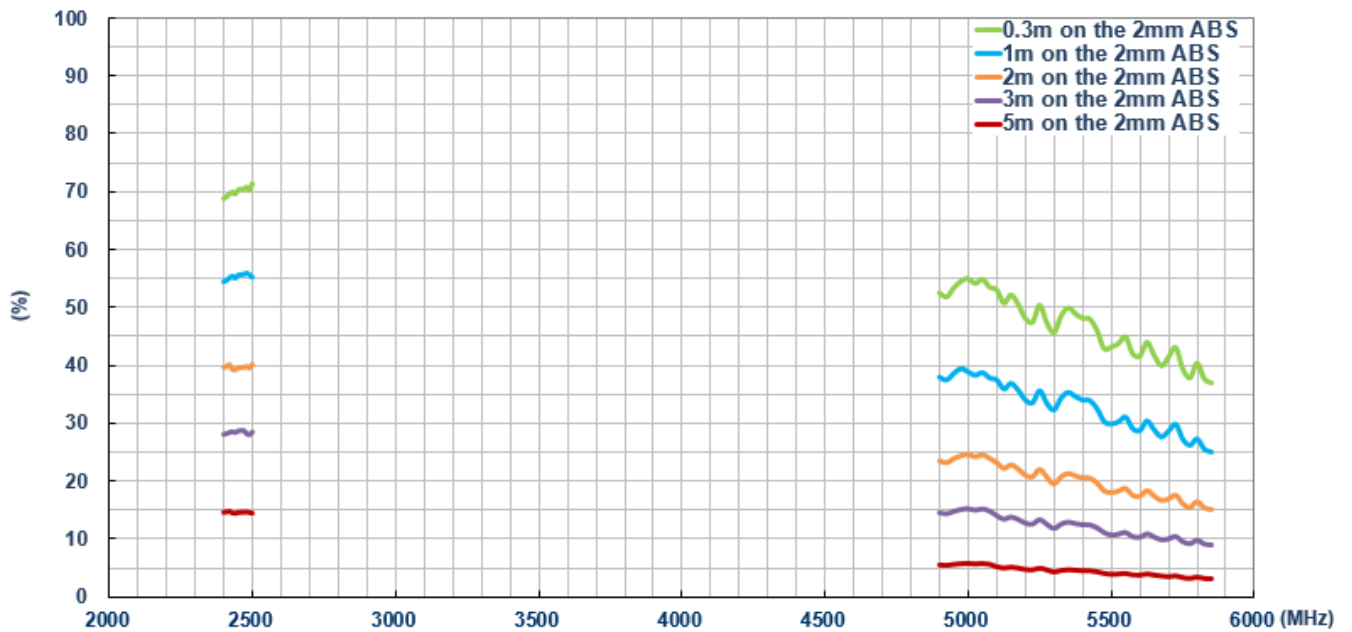



Peak Gain

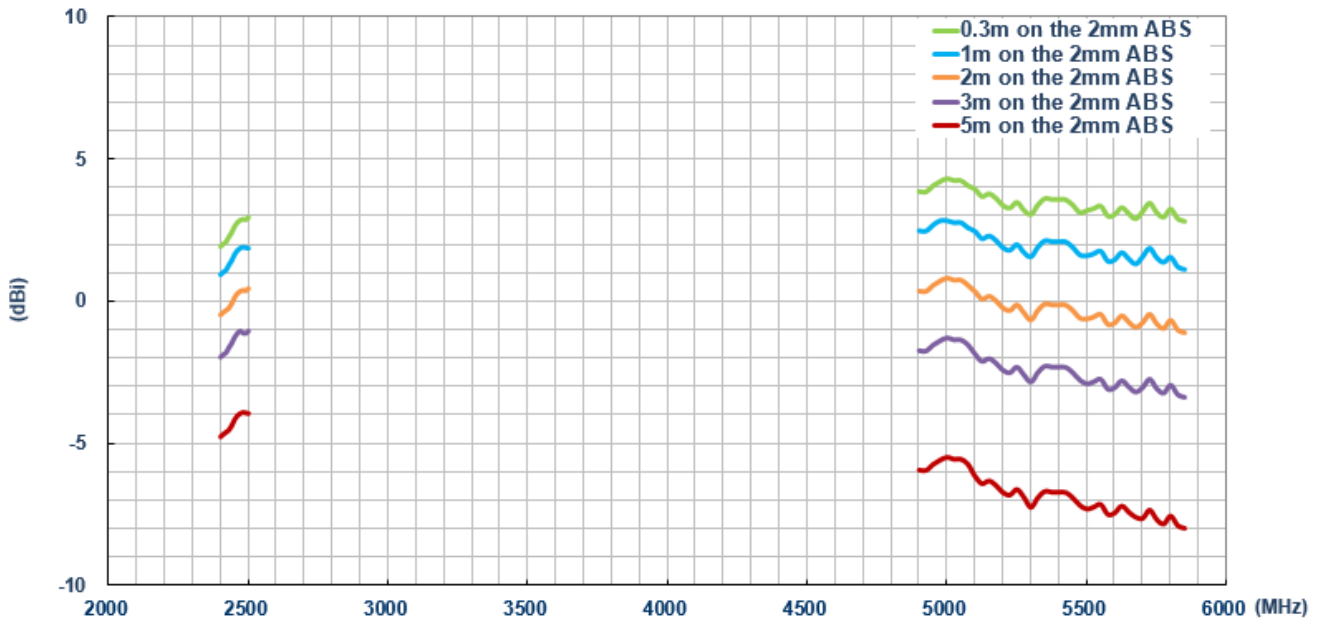

Average Gain

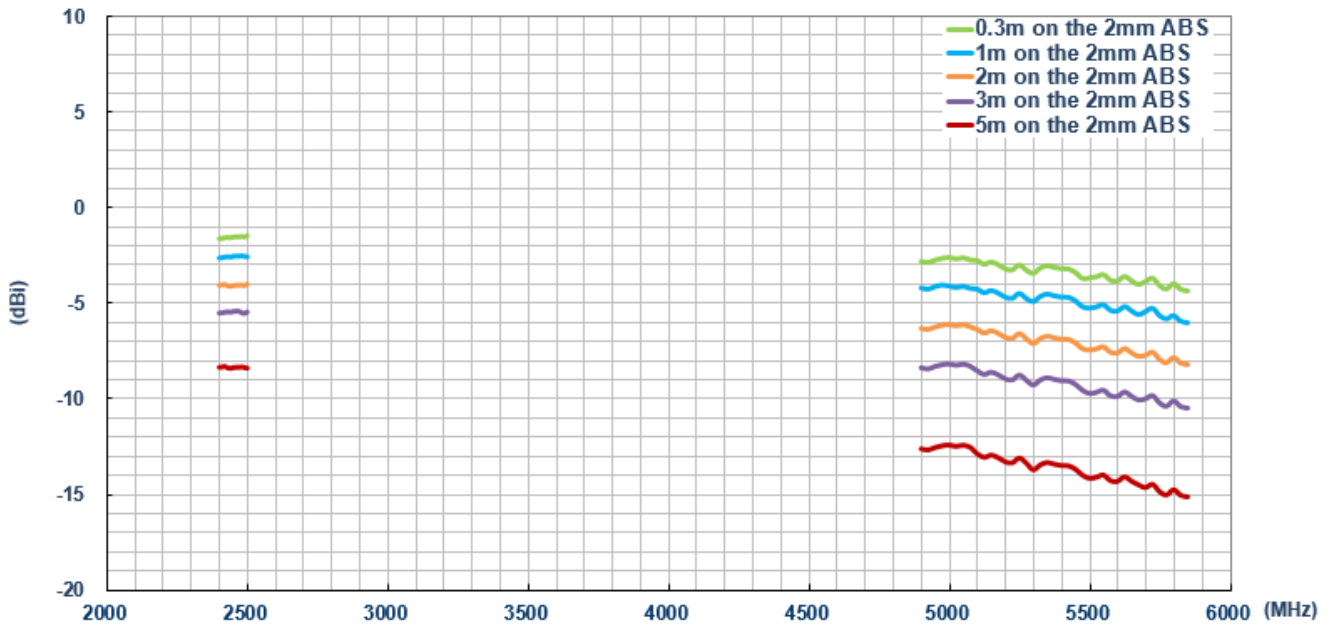



Taoglas makes no warranties based on the accuracy or completeness of the contents of this document and reserves the right to make changes to specifications and product descriptions at any time without notice. Taoglas reserves all rights to this document and the information contained herein.

Reproduction, use or disclosure to third parties without express permission is strictly prohibited.

© Taoglas