

Dimensions: [mm]

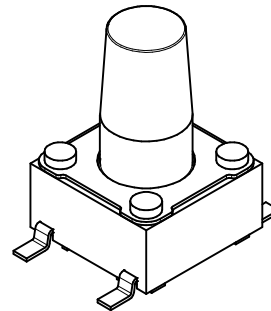

Recommended Land Pattern: [mm]

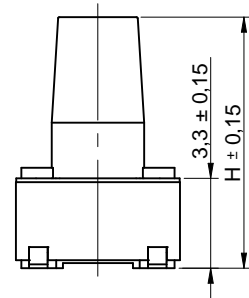
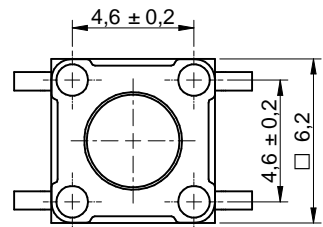
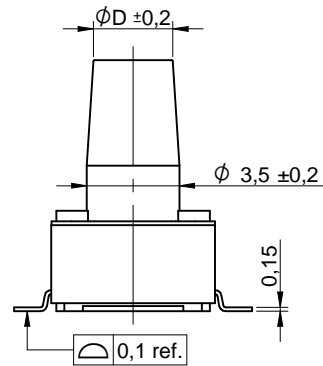
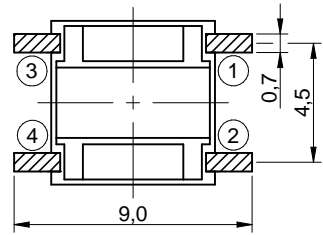
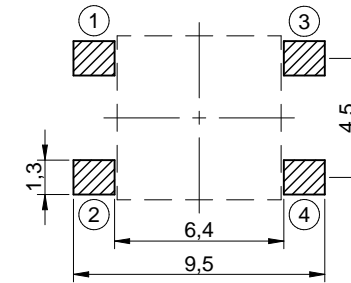

Scale - 3:1

Schematic:

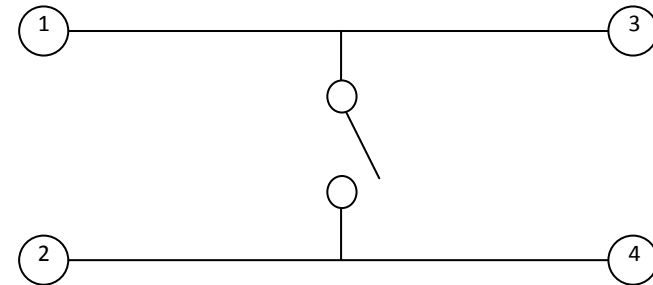

Dimensions:

Properties		Value	Unit
Height	H	8	mm
Diameter	ϕD	3	mm

Würth Elektronik eiSos GmbH & Co. KG
EMC & Inductive Solutions

Max-Eyth-Str. 1
74638 Waldenburg
Germany
Tel. +49 (0) 79 42 945 - 0

www.we-online.com
eiSos@we-online.com



CREATED DaSc	CHECKED eLin	GENERAL TOLERANCE DIN ISO 2768-1m	PROJECTION METHOD
DESCRIPTION 6x6mm SMD Tact Switch WS-TASV		ORDER CODE 430152080836	
REVISION 002.000	STATUS Valid	DATE (YYYY-MM-DD) 2018-06-26	BUSINESS UNIT eiCan
		PAGE 1/5	

Material Properties:

Cover Material	Stainless Steel
Actuator Material	LCP
Actuator Flammability Rating	UL94 V-0
Actuator Color	Salmon
Frame Material	LCP
Frame Flammability Rating	UL94 V-0
Frame Color	Black
Contact Material	Stainless Steel
Contact Plating	Silver
Terminal Material	Copper Alloy
Terminal Plating	Silver

Electrical Properties:

Properties	Test conditions		Value	Unit	Tol.
Rated Current	12 V (DC)	I_R	50	mA	
Contact Resistance Initial		R	100	m Ω	max.
Contact Resistance After Life Test		R	2	Ω	max.
Insulation Resistance	500 V (DC)	R_{ISO}	100	M Ω	min.
Withstanding Voltage	1 min		250	V (AC)	
Bounce			10	ms	max.

Mechanical Properties:

Properties	Value	Unit	Tol.
Operation Force	360	g	$\pm 50g$
Life Cycle	200000	Times	
Stroke	0.25	mm	$\pm 0.15mm$

General Information:

Operating Temperature	-40 °C up to +85 °C
Storage Conditions (in original packaging)	< 40 °C ; < 75 % RH
Moisture Sensitive Level (MSL)	1

Packaging Properties:

Properties	Value
Packaging	Tape and Reel
Packaging Unit	Qty. 400

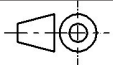
Würth Elektronik eiSos GmbH & Co. KG EMC & Inductive Solutions Max-Eyth-Str. 1 74638 Waldenburg Germany Tel. +49 (0) 79 42 945 - 0 www.we-online.com eiSos@we-online.com	CREATED DaSc	CHECKED eLin	GENERAL TOLERANCE DIN ISO 2768-1m	PROJECTION METHOD 	
	DESCRIPTION 6x6mm SMD Tact Switch WS-TASV			ORDER CODE 430152080836	
	REVISION 002.000	STATUS Valid	DATE (YYYY-MM-DD) 2018-06-26	BUSINESS UNIT eiCan	PAGE 2/5



Classification Reflow Profile for SMT components:



Classification Reflow Soldering Profile:

Profile Feature		Value
Preheat Temperature Min ¹⁾	$T_{s \text{ min}}$	150 °C
Preheat Temperature Max	$T_{s \text{ max}}$	200 °C
Preheat Time t_s from $T_{s \text{ min}}$ to $T_{s \text{ max}}$	t_s	60 - 120 seconds
Ramp-up Rate (T_L to T_p)		3 °C/ second max.
Liquidous Temperature	T_L	217 °C
Time t_L maintained above T_L	t_L	60 - 150 seconds
Peak package body temperature	T_p	see table
Time within 5°C of actual peak temperature	t_p	20 - 30 seconds
Ramp-down Rate (T_L to T_p)		6 °C/ second max.
Time 25°C to peak temperature		8 minutes max.

¹⁾ refer to IPC/JEDEC J-STD-020D
refer to IPC/ JEDEC J-STD-020E

Package Classification Reflow Temperature:

Properties	Volume mm ³ <350	Volume mm ³ 350-2000	Volume mm ³ >2000
PB-Free Assembly Package Thickness < 1.6 mm ¹⁾	260 °C	260 °C	260 °C
PB-Free Assembly Package Thickness 1.6 mm - 2.5 mm	260 °C	250 °C	245 °C
PB-Free Assembly Package Thickness ≥ 2.5 mm	250 °C	245 °C	245 °C

¹⁾ refer to IPC/JEDEC J-STD-020D
refer to IPC/ JEDEC J-STD-020E

Würth Elektronik eiSos GmbH & Co. KG
EMC & Inductive Solutions

Max-Eyth-Str. 1
74638 Waldenburg
Germany
Tel. +49 (0) 79 42 945 - 0

www.we-online.com
eiSos@we-online.com



CREATED DaSc	CHECKED eLin	GENERAL TOLERANCE DIN ISO 2768-1m	PROJECTION METHOD
DESCRIPTION 6x6mm SMD Tact Switch WS-TASV		ORDER CODE 430152080836	
REVISION 002.000	STATUS Valid	DATE (YYYY-MM-DD) 2018-06-26	BUSINESS UNIT eiCan
		PAGE 3/5	

Cautions and Warnings:

The following conditions apply to all Tact Switches (hereinafter referred as to “switch” or “Tact switch”) of Würth Elektronik eiSos GmbH & Co. KG:

General:

- This switch is designed and developed with the intention for use in general electronics equipment.
- Before incorporating the switch into any equipment in the field such as aerospace, aviation, nuclear control, submarine, transportation, (automotive control, train control, ship control), transportation signal, disaster prevention, medical, public information network etc. where higher safety and reliability are especially required or if there is possibility of direct damage or injury to human body, Würth Elektronik must be asked for a written approval.
- In addition, even switches in general electronic equipment, when used in electrical circuits that require high safety, reliability functions or performance, the sufficient reliability evaluation-check for the safety must be performed by the user before usage.
- The switch is designed and manufactured to be used within the datasheet specified values.
- Do not use the switch outside the datasheet specifications.
- Prevent any damage or scratches on the switch, especially on the actuator.
- Direct mechanical impact to the switch shall be prevented (e.g. overlapping of the PCB's).
- The responsibility for the applicability of the customer specific products and use in a particular customer design is always within the authority of the customer. All technical specification for standard products do also apply to customer specific products.

Product Specific:

Soldering:

- The solder profile must comply with the WE technical soldering specification; otherwise, the warranty will be void.
- For reflow soldering limitation of two times is recommended. Hand soldering max. 350°C for 3 sec max..
- Other soldering methods (e.g. vapor phase) are not verified and have to be validated by the customer on his own risk.

Cleaning and Washing:

- Non-washable series are parts without ‘washable’ label in the catalog: The switch is not constructed for washing, so washing can cause malfunction afterwards.
- ‘Washable’ series are those with ‘washable’ label in the catalog: Cleaning agents that are used to clean the customer applications might damage or change the characteristics of the switch, body, pins and termination.
- Please do not submerge our washable products into water or cleaning agents or put them in locations exposed to water completely.
- Do not clean washable series immediately after soldering. The cleaning agent may be absorbed into the switch through respiration while the switch cools.
- When cleaning by hand (brushing), please do not use excessive force on our switch to avoid malfunction afterwards, otherwise relevant areas for the function of the switch might get deformed.

Potting and Coating:

- If the switch is potted or coated in customer applications, the potting or coating material might shrink during and after hardening; thus the switch is exposed to the pressure of the potting material with the effect that the switch possibly might get damaged by this pressure with the outcome that the electrical as well as the mechanical characteristics are in danger of being affected. After the potting or coating material is cured, the switch needs to be checked if any malfunction or destructions on the switch has occurred.

Handling of Product:

- For Hermetic series Tact switch, please refer to the aforementioned ‘Cleaning and washing’ definition to process if needed.
- Please do not press actuator or change status /position during the cleaning and washing process.
- Do not repeatedly operate the switch with excessive force. It may damage or deforms the contact dome which results in malfunction.
- Please set up the switch in such way that the actuator will operate in a straight vertical line. A decrease in the lifetime of the switch may result if the actuator is pressed off-center or from an angle. This might cause function errors or broken actuators, especially for the height of more than 7.0mm.
- Design the right angle part with consideration of the wave soldering process so that the parts will not touch the soldering wave during the soldering process or protect the switch part with cover fixture. Melt of the switch might cause malfunction.

Operation and Storage conditions:

- -40°C ~ +85°C
- In case a switch requires particular handling precautions in addition to the general recommendations mentioned here before, these will appear on the product datasheet.
- The switch shall be used before the end of the period of 12 months based on the product date code; otherwise, 100% solderability cannot be warranted.

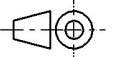
Würth Elektronik eiSos GmbH & Co. KG EMC & Inductive Solutions Max-Eyth-Str. 1 74638 Waldenburg Germany Tel. +49 (0) 79 42 945 - 0 www.we-online.com eiSos@we-online.com	CREATED DaSc	CHECKED eLin	GENERAL TOLERANCE DIN ISO 2768-1m	PROJECTION METHOD 	
	DESCRIPTION 6x6mm SMD Tact Switch WS-TASV			ORDER CODE 430152080836	
		REVISION 002.000	STATUS Valid	DATE (YYYY-MM-DD) 2018-06-26	BUSINESS UNIT eiCan

Important Notes

The following conditions apply to all goods within the product range of Würth Elektronik eiSos GmbH & Co. KG:

1. General Customer Responsibility

Some goods within the product range of Würth Elektronik eiSos GmbH & Co. KG contain statements regarding general suitability for certain application areas. These statements about suitability are based on our knowledge and experience of typical requirements concerning the areas, serve as general guidance and cannot be estimated as binding statements about the suitability for a customer application. The responsibility for the applicability and use in a particular customer design is always solely within the authority of the customer. Due to this fact it is up to the customer to evaluate, where appropriate to investigate and decide whether the device with the specific product characteristics described in the product specification is valid and suitable for the respective customer application or not.

2. Customer Responsibility related to Specific, in particular Safety-Relevant Applications

It has to be clearly pointed out that the possibility of a malfunction of electronic components or failure before the end of the usual lifetime cannot be completely eliminated in the current state of the art, even if the products are operated within the range of the specifications. In certain customer applications requiring a very high level of safety and especially in customer applications in which the malfunction or failure of an electronic component could endanger human life or health it must be ensured by most advanced technological aid of suitable design of the customer application that no injury or damage is caused to third parties in the event of malfunction or failure of an electronic component. Therefore, customer is cautioned to verify that data sheets are current before placing orders. The current data sheets can be downloaded at www.we-online.com.

3. Best Care and Attention

Any product-specific notes, cautions and warnings must be strictly observed. Any disregard will result in the loss of warranty.

4. Customer Support for Product Specifications

Some products within the product range may contain substances which are subject to restrictions in certain jurisdictions in order to serve specific technical requirements. Necessary information is available on request. In this case the field sales engineer or the internal sales person in charge should be contacted who will be happy to support in this matter.

5. Product R&D

Due to constant product improvement product specifications may change from time to time. As a standard reporting procedure of the Product Change Notification (PCN) according to the JEDEC-Standard inform about minor and major changes. In case of further queries regarding the PCN, the field sales engineer or the internal sales person in charge should be contacted. The basic responsibility of the customer as per Section 1 and 2 remains unaffected.

6. Product Life Cycle



Due to technical progress and economical evaluation we also reserve the right to discontinue production and delivery of products. As a standard reporting procedure of the Product Termination Notification (PTN) according to the JEDEC-Standard we will inform at an early stage about inevitable product discontinuance. According to this we cannot guarantee that all products within our product range will always be available. Therefore it needs to be verified with the field sales engineer or the internal sales person in charge about the current product availability expectancy before or when the product for application design-in disposal is considered. The approach named above does not apply in the case of individual agreements deviating from the foregoing for customer-specific products.

7. Property Rights

All the rights for contractual products produced by Würth Elektronik eiSos GmbH & Co. KG on the basis of ideas, development contracts as well as models or templates that are subject to copyright, patent or commercial protection supplied to the customer will remain with Würth Elektronik eiSos GmbH & Co. KG. Würth Elektronik eiSos GmbH & Co. KG does not warrant or represent that any license, either expressed or implied, is granted under any patent right, copyright, mask work right, or other intellectual property right relating to any combination, application, or process in which Würth Elektronik eiSos GmbH & Co. KG components or services are used.

8. General Terms and Conditions

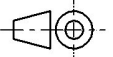
Unless otherwise agreed in individual contracts, all orders are subject to the current version of the "General Terms and Conditions of Würth Elektronik eiSos Group", last version available at www.we-online.com.

Würth Elektronik eiSos GmbH & Co. KG EMC & Inductive Solutions Max-Eyth-Str. 1 74638 Waldenburg Germany Tel. +49 (0) 79 42 945 - 0 www.we-online.com eiSos@we-online.com	CREATED DaSc	CHECKED eLin	GENERAL TOLERANCE DIN ISO 2768-1m	PROJECTION METHOD 
	DESCRIPTION 6x6mm SMD Tact Switch WS-TASV		ORDER CODE 430152080836	
		REVISION 002.000	STATUS Valid	DATE (YYYY-MM-DD) 2018-06-26
			PAGE 5/5	