

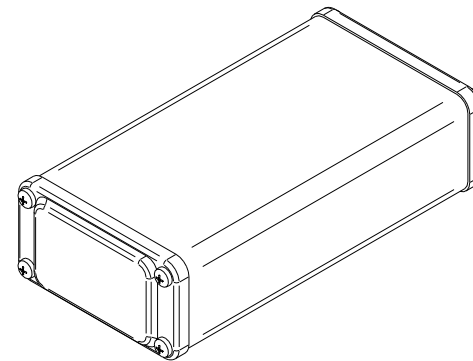

MAXIMUM PCB SIZE

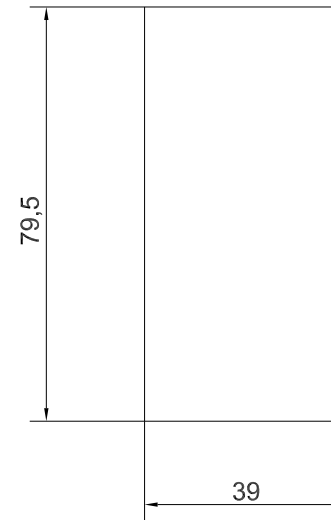
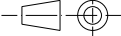

	Denomination	Part. Number		
	Assembly MINITEKAL480		MTK480	
	Subject to technical modification without prior notice. Tipographical and other errors do not justify any claim for damages. All dimensions should be verified using an actual moulded part.		Rev. Index	Scale
	This document contains proprietary information of TEKO S.p.a. and is tendered subject to the conditions that the information be retained in confidence not be reproduced or copied and not be used or incorporated in any product.		Date	1:1 Format design A3
		20/04/2007		