

Multifunction Counter/Tachometer H7CX Series

Please read and understand this catalog before purchasing the products. Please consult your OMRON representative if you have any questions or comments. Refer to *Warranty and Application Considerations* (page 64), and *Safety Precautions* (page 59).

DIN 48 × 48 mm Multifunction Counter/Tachometer Series

- Highly visible display with backlit negative transmissive LCD.
- Intuitive setting enabled using ergonomic up/down digit keys (4-digit models) and DIP switch.
- PNP/NPN switchable DC voltage input.
- Finger-safe terminals (screw terminal block models).
- Complies with IP66/NEMA4/UL Type 4X (when using the Y92S-29 Waterproof Packing and Y92F-30 Flush Mounting Adapter).

H7CX Series



H7CX-A
Multifunction Counter
Preset Counter
Total Counter
Batch Counter
Dual Counter
Tachometer



H7CX-R
Tachometer

Contents

Multifunction Counter

H7CX-A..... 2

Tachometer

H7CX-R..... 42

Common to All Models

Safety Precautions..... 59

Warranty and Application Consideration..... 64

Multifunction Preset Counter H7CX-A

DIN 48 × 48 mm Multifunction Preset Counter with a Bright, Easy-to-view, Negative Transmissive LCD

- Programmable PV color to visually alert when output status changes (screw terminal block models).
- Configurable as 1-stage counter, 2-stage counter, total and pre-set counter, batch counter, dual counter, or tachometer. (Configurability varies with model.)
- Meets a variety of mounting requirements: Screw terminal block models, and pin-style terminal models.
- Six-language instruction manual.



Contents

Model Number Structure	3
Ordering Information	3
Specifications	4
Connections	8
Nomenclature	12
Dimensions.....	13
Operating Procedures	17
Setting Procedure Guide.....	17
Operating Procedures (Counter Function).....	18
Operating Procedures (Tachometer Function).....	30
Operation in Configuration Selection Mode	36
Additional Information.....	37

Model Number Structure

Model Number Legend

H7CX-A□□□□□□
 1 2 3 4 5 6

1. External connection

- None: Screw terminals
- 11: 11-pin socket

2. No. of digits

- None: 6 digits
- 4: 4 digits

3. Stage setting

- None: 1-stage setting
- U: Factory-set to 1-stage setting
- W: Factory-set to 2-stage setting

4. Output type

- None: Contact output or contact and transistor in combination
- S: Transistor output

5. Supply voltage/external power supply

- None: 100 to 240 VAC at 50/60 Hz with 12 VDC power supply
- D: 12 to 24 VDC without external power supply
- D1: 12 to 24 VDC or 24 VAC at 50/60 Hz with 12 VDC power supply

6. Case color

- None: Black
- G: Light gray (Munsell 5Y7/1): Produced upon request.

Ordering Information

List of Models

Supported configurations			11-pin socket				Screw terminal		
Sensor power supply	Output type	Supply voltage	1-stage				1-stage (See note.)	2-stage	
			6 digits	4 digits	6 digits	4 digits		6 digits	6 digits
			H7CX-A11□	H7CX-A114□	H7CX-A□	H7CX-A4□	H7CX-AU□	H7CX-AW□	H7CX-A4W□
12 VDC	Contact output	100 to 240 VAC	H7CX-A11	H7CX-A114	H7CX-A	H7CX-A4	---	H7CX-AW	H7CX-A4W
		12 to 24 VDC/24 VAC	H7CX-A11D1	H7CX-A114D1	---	---	---	H7CX-AWD1	---
	Contact and transistor output	100 to 240 VAC	---	---	---	---	H7CX-AU	---	---
		12 to 24 VDC/24 VAC	---	---	---	---	H7CX-AUD1	---	---
	Transistor output	100 to 240 VAC	H7CX-A11S	H7CX-A114S	H7CX-AS	H7CX-A4S	---	H7CX-AWS	---
		12 to 24 VDC/24 VAC	H7CX-A11SD1	---	---	---	H7CX-AUSD1	H7CX-AWSD1	---
None	Contact output	12 to 24 VDC	---	---	H7CX-AD	H7CX-A4D	---	---	
	Transistor output	---	---	H7CX-ASD	H7CX-A4SD	---	H7CX-AWSD	H7CX-A4WSD	

Note: Can be used as a 2-stage counter. In this case, each output can be flexibly allocated to either stage 1 or 2.

Accessories (Order Separately)

Name	Models	
Flush Mounting Adapter (See note 1.)	Y92F-30	
Waterproof Packing (See note 1.)	Y92S-29	
Track Mounting/Front Connecting Socket	11-pin	P2CF-11
	11-pin, finger-safe type	P2CF-11-E
Back Connecting Socket	11-pin	P3GA-11
	11-pin, finger-safe type	P3GA-11 with Y92A-48G (See note 2.)
Hard Cover	Y92A-48	
Soft Cover	Y92A-48F1	
Mounting Track	50 cm (l) × 7.3 mm (t)	PFP-50N
	1 m (l) × 7.3 mm (t)	PFP-100N
	1 m (l) × 16 mm (t)	PFP-100N2
End Plate	PFP-M	
Spacer	PFP-S	

- Note: 1. Supplied with screw-terminal models (i.e., excluding H7CX-A11□/-A114□ models).
- 2. Y92A-48G is a finger-safe terminal cover attached to the P3GA-11 Socket.

Specifications

■ Ratings

Item	H7CX-A4□	H7CX-A□	H7CX-A114□	H7CX-A11□
Classification	Preset counter			
Supported configurations	1-stage counter, 1-stage counter with total counter (selectable)			
Rated supply voltage (See note 1.)	100 to 240 VAC (50/60 Hz), 12 to 24 VDC		100 to 240 VAC (50/60 Hz) 24 VAC (50/60 Hz)/12 to 24 VDC	
Operating voltage range	85% to 110% of rated supply voltage (90% to 110% at 12 VDC)			
Power consumption	Approx. 9.2 VA at 264 VAC Approx. 7.2 VA at 26.4 VAC Approx. 3.7 W at 12 VDC			
Mounting method	Flush mounting		Flush mounting, surface mounting, or DIN track mounting	
External connections	Screw terminals		11-pin socket	
Terminal screw tightening torque	0.5 N·m max.		---	
Display (See note 2.)	7-segment, negative transmissive LCD			
	PV	11.5-mm-high characters, red or green (programmable)	9-mm-high characters, red or green (programmable)	11.5-mm-high characters, red
	SV	6-mm-high characters, green		9-mm-high characters, red
Digits	4 digits (–999 to 9,999) SV range: 0 to 9,999	6 digits (–99,999 to 999,999) SV range: –99,999 to 999,999 (See note 3.) or 0 to 999,999	4 digits (–999 to 9,999) SV range: 0 to 9,999	6 digits (–99,999 to 999,999) SV range: –99,999 to 999,999 (See note 3.) or 0 to 999,999
Max. counting speed	30 Hz or 5 kHz (selectable, ON/OFF ratio 1:1), common setting for CP1 and CP2			
Input modes	Increment, decrement, command, individual, and quadrature			
Input signals	CP1, CP2, reset, and total reset			
Input method	No-voltage input/voltage input (switchable) <u>No-voltage input</u> ON impedance: 1 kΩ max. (Leakage current: 5 to 20 mA at 0 Ω) ON residual voltage: 3 V max. OFF impedance: 100 kΩ min. <u>Voltage input</u> High (logic) level: 4.5 to 30 VDC Low (logic) level: 0 to 2 VDC (Input resistance: approx. 4.7 kΩ)			
Reset input	Minimum reset input signal width: 1 or 20 ms (selectable), common setting for all inputs			
Reset system	External, manual, and automatic reset (internal according to C, R, P, and Q mode operation)			
Output modes	N, F, C, R, K-1, P, Q, A	N, F, C, R, K-1, P, Q, A, K-2, D, L	N, F, C, R, K-1, P, Q, A	N, F, C, R, K-1, P, Q, A, K-2, D, L
One-shot output time	0.01 to 99.99 s			
Output type	Contact type: SPDT Transistor type: 1 transistor			
Control output	Contact output: 3 A at 250 VAC/30 VDC, resistive load (cosφ=1) Minimum applied load: 10 mA at 5 VDC (failure level: P, reference value) Transistor output: NPN open collector, 100 mA at 30 VDC Residual voltage: 1.5 VDC max. (approx. 1 V) Leakage current: 0.1 mA max. NEMA B300 Pilot Duty, 1/4 HP 3-A resistive load at 120 VAC, 1/3 HP 3-A resistive load at 240 VAC			
External power supply	12 VDC (±10%), 100 mA (except for H7CX-A□D models) Refer to <i>Safety Precautions</i> (page 60) for details.			
Key protection	Yes			
Prescaling function	Yes (0.001 to 9.999)	Yes (0.001 to 99.999)	Yes (0.001 to 9.999)	Yes (0.001 to 99.999)
Decimal point adjustment	Yes (rightmost 3 digits)			
Sensor waiting time	250 ms max. (Control output is turned OFF and no input is accepted during sensor waiting time.)			
Memory backup	EEPROM (overwrites: 100,000 times min.) that can store data for 10 years min.			
Ambient temperature	Operating: –10 to 55°C (–10 to 50°C if counters are mounted side by side) (with no icing or condensation) Storage: –25 to 65°C (with no icing or condensation)			
Ambient humidity	25% to 85%			
Case color	Black (N1.5), light gray (Munsell 5Y7/1, produced upon request)			
Attachments	Waterproof packing, flush mounting adapter		None	

- Note:**
1. Permissible ripple: 20% (p-p) max.
 2. The display is lit only when the power is ON.
 3. Only when the following modes are selected.
Input mode: command, individual, or quadrature; output mode: K-2, D, or L

■ Ratings (contd.)

Item	H7CX-A4W□	H7CX-AW□	H7CX-AU□	
Classification	Preset counter	Preset counter/tachometer		
Supported configurations	1-stage counter, 2-stage counter, 1-stage counter with total counter, 1-stage counter with batch counter, dual counter (addition only) (selectable)	1-stage counter, 2-stage counter, 1-stage counter with total counter, 1-stage counter with batch counter, dual counter (addition/subtraction), tachometer (selectable)		
Rated supply voltage (See note 1.)	100 to 240 VAC (50/60 Hz), 12 to 24 VDC	100 to 240 VAC (50/60 Hz), 24 VAC (50/60 Hz)/12 to 24 VDC, 12 to 24 VDC	100 to 240 VAC (50/60 Hz), 24 VAC (50/60 Hz)/12 to 24 VDC	
Operating voltage range	85% to 110% of rated supply voltage (90% to 110% at 12 VDC)			
Power consumption	Approx. 9.2 VA at 264 VAC Approx. 7.2 VA at 26.4 VAC Approx. 3.7 W at 12 VDC			
Mounting method	Flush mounting			
External connections	Screw terminals			
Terminal screw tightening torque	0.5 N·m max.			
Display (See note 2.)	7-segment, negative transmissive LCD			
	PV	11.5-mm-high characters, red or green (programmable)	9-mm-high characters, red or green (programmable)	
	SV	6-mm-high characters, green		
Digits	4 digits (-999 to 9,999) SV range: 0 to 9,999	6 digits (-99,999 to 999,999 or 0 to 999,999 when using as Tachometer) SV range: -99,999 to 999,999 (See note 3.) or 0 to 999,999		
Input signals	CP1, CP2, reset 1, and reset 2			
Input method	No-voltage input/voltage input (switchable) <u>No-voltage input</u> ON impedance: 1 kΩ max. (Leakage current: 5 to 20 mA at 0 Ω) ON residual voltage: 3 V max. OFF impedance: 100 kΩ min. <u>Voltage input</u> High (logic) level: 4.5 to 30 VDC Low (logic) level: 0 to 2 VDC (Input resistance: approx. 4.7 kΩ)			
Counter	Max. counting speed	30 Hz or 5 kHz (selectable, ON/OFF ratio 1:1), common setting for CP1 and CP2		
	Input mode	Increment, decrement, command, individual, and quadrature		
	Reset input	Minimum reset input signal width: 1 or 20 ms (selectable), common setting for all inputs		
	Reset system	External, manual, and automatic reset (internal according to C, R, P, and Q mode operation)		
	Output modes	N, F, C, R, K-1, P, Q, A	N, F, C, R, K-1, P, Q, A, K-2, D, L, H	
	One-shot output time	0.01 to 99.99 s		
Tachometer	Pulse measurement method	---	Periodic measurement (Sampling period: 200 ms)	
	Max. counting speed	---	30 Hz or 10 kHz (selectable)	
	Measuring ranges	---	30 Hz: 0.01 to 30.00 Hz 10 kHz: 0.01 Hz to 10 kHz	
	Measuring accuracy	---	±0.1% FS ±1 digit max. (at 23 ±5°C)	
	Output modes	---	HI-LO, AREA, HI-HI, LO-LO	
	Auto-zero time	---	0.1 to 99.9 s	
	Startup time	---	0.0 to 99.9 s	
	Average processing	---	OFF/2/4/8 times	
Output type	H7CX-A4W/-AW/-AWD1: SPDT (OUT2) and SPST-NO (OUT1) H7CX-A4WSD/-AWS/-AWSD/-AWSD1: 2 transistors		H7CX-AU/-AUD1: SPDT and 1 transistor H7CX-AUSD1: 2 transistors (Output allocation possible)	
Control output	Contact output: 3 A at 250 VAC/30 VDC, resistive load (cosφ=1) Minimum applied load: 10 mA at 5 VDC (failure level: P, reference value) Transistor output: NPN open collector, 100 mA at 30 VDC Residual voltage: 1.5 VDC max. (approx. 1 V) Leakage current: 0.1 mA max. NEMA B300 Pilot Duty, 1/4 HP 3-A resistive load at 120 VAC, 1/3 HP 3-A resistive load at 240 VAC			
External power supply	12 VDC (±10%), 100 mA (except for H7CX-A□□D models) Refer to <i>Safety Precautions</i> (page 60) for details.			
Key protection	Yes			
Prescaling function	Yes (0.001 to 9.999)	Yes (0.001 to 99.999)		
Decimal point adjustment	Yes (rightmost 3 digits)			
Sensor waiting time	250 ms max. (Control output is turned OFF and no input is accepted during sensor waiting time.)			
Memory backup	EEPROM (overwrites: 100,000 times min.) that can store data for 10 years min.			
Ambient temperature	Operating: -10 to 55°C (-10 to 50°C if counters are mounted side by side) (with no icing or condensation) Storage: -25 to 65°C (with no icing or condensation)			
Ambient humidity	25% to 85%			
Case color	Black (N1.5), light gray (Munsell 5Y7/1, produced upon request)			
Attachments	Waterproof packing, flush mounting adapter	Waterproof packing, flush mounting adapter, labels for counter/tachometer DIP switch settings		

- Note:**
1. Permissible ripple: 20% (p-p) max.
 2. The display is lit only when the power is ON.
 3. Only when the following modes are selected.
 - Input mode: command, individual, or quadrature; output mode: K-2, D, L, or H
 - Dual count calculating mode: SUB; output mode: K-2, D, L, or H in dual counter operation

■ Characteristics

item	H7CX
Insulation resistance	100 MΩ min. (at 500 VDC) between current-carrying terminal and exposed non-current-carrying metal parts, and between non-continuous contacts
Dielectric strength	2,000 VAC, 50/60 Hz for 1 min between current-carrying metal parts and non-current-carrying metal parts 2,000 VAC (for 100 to 240 VAC), 50/60 Hz for 1 min between power supply and input circuit (1,000 VAC for 24 VAC/12 to 24 VDC) 1,000 VAC (for H7CX-□SD/-□SD1), 50/60 Hz for 1 min between control output, power supply, and input circuit (2,000 VAC for models other than H7CX-□SD/-□SD1) 1,000 VAC, 50/60 Hz for 1 min between non-continuous contacts
Impulse withstand voltage	3 kV (between power terminals) for 100 to 240 VAC, 1 kV for 24 VAC/12 to 24 VDC and 12 to 24 VDC 4.5 kV (between current-carrying terminal and exposed non-current-carrying metal parts) for 100 to 240 VAC, 1.5 kV for 24 VAC/12 to 24 VDC and 12 to 24 VDC
Noise immunity	±1.5 kV (between power terminals) for 100 to 240 VAC and 24 VAC/12 to 24 VDC, ±480 V for 12 to 24 VDC ±600 V (between input terminals) Square-wave noise by noise simulator (pulse width: 100 ns/1 μs, 1-ns rise)
Static immunity	Destruction: 15 kV Malfunction: 8 kV
Vibration resistance	Destruction: 10 to 55 Hz with 0.75-mm single amplitude, four cycles each in three directions (8 minutes per cycle) Malfunction: 10 to 55 Hz with 0.35-mm single amplitude, four cycles each in three directions (8 minutes per cycle)
Shock resistance	Destruction: 294 m/s ² each in three directions Malfunction: 98 m/s ² each in three directions
Life expectancy	Mechanical: 10,000,000 operations min. Electrical: 100,000 operations min. (3 A at 250 VAC, resistive load) See <i>Life-test Curve</i> on page 7.
Approved safety standards (See notes 1 and 2.)	UL508/Listing, UL 50 Type 4X for indoor use (enclosure rating) CSA C22.2 No. 14, conforms to EN61010-1 (Pollution degree 2/overvoltage category II) Conforms to VDE0106/P100 (finger protection).
EMC	(EMI) EN61326 Emission Enclosure: EN55011 Group 1 class A Emission AC mains: EN55011 Group 1 class A (EMS) EN61326 Immunity ESD: EN61000-4-2: 4 kV contact discharge (level 2); 8 kV air discharge (level 3) Immunity RF-interference: EN61000-4-3: 10 V/m (Amplitude-modulated, 80 MHz to 1 GHz) (level 3); 10 V/m (Pulse-modulated, 900 MHz ±5 MHz) (level 3) Immunity Conducted Disturbance: EN61000-4-6: 10 V (0.15 to 80 MHz) (level 3) Immunity Burst: EN61000-4-4: 2 kV power-line (level 3); 1 kV I/O signal-line (level 4) Immunity Surge: EN61000-4-5: 1 kV line to lines (power and output lines) (level 2); 2 kV line to ground (power and output lines) (level 3) Immunity Voltage Dip/Interruption: EN61000-4-11: 0.5 cycle, 100% (rated voltage)
Degree of protection	Panel surface: IP66, NEMA 4 (indoors), and UL Type 4X (indoors) (See note 2.)
Weight	Approx. 140 g

- Note:**
- To meet UL listing requirements with the H7CX-A11□ models, an OMRON P2CF-11-□ or P3GA-11 Socket must be mounted on the H7CX. Otherwise, H7CX-A11□ models are considered to meet UL508 recognition requirements.
 - The Y92S-29 Waterproof Packing and Y92F-30 Flush Mounting Adapter are necessary to ensure IP66, NEMA4, and UL Type 4X waterproofing between the H7CX and installation panel.

Life-test Curve (Reference Values)

Resistive Load

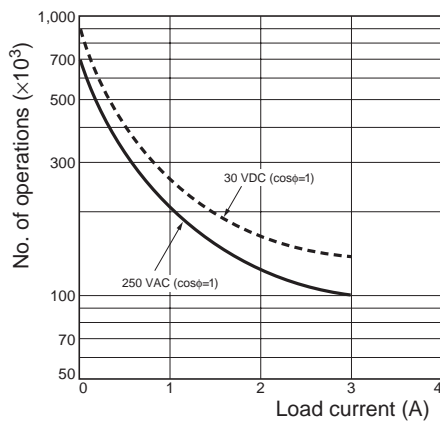

Inductive Load

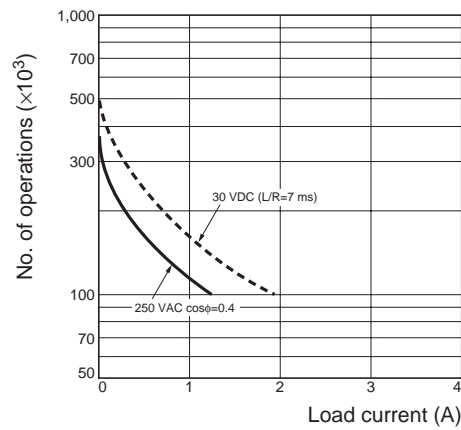

Reference: A current of 0.15 A max. can be switched at 125 VDC ($\cos\phi=1$) and current of 0.1 A max. can be switched if $L/R=7$ ms. In both cases, a life of 100,000 operations can be expected. The minimum applicable load is 10 mA at 5 VDC (failure level: P).

Inrush Current (Reference Values)

Model	Voltage	Applied voltage	Inrush current (peak value)	Time
H7CX-A11/-AW	100 to 240 VAC	264 VAC	5.8 A	0.7 ms
H7CX-A11D1/-AWD1	24 VAC/12 to 24 VDC	26.4 VAC	10.4 A	1.2 ms
H7CX-AD	12 to 24 VDC	26.4 VDC	6.0 A	1.2 ms

Connections

■ Block Diagram

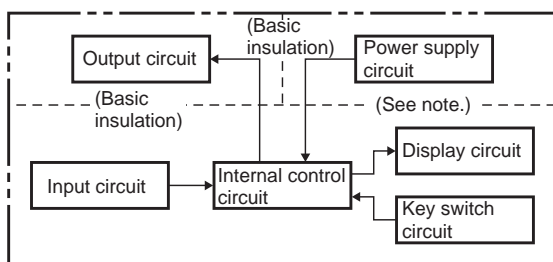

Note: All models except for H7CX-□D (models with 12 to 24-VDC power supplies) have basic insulation.

■ I/O Functions

Using as a Counter

Inputs	CP1, CP2	<ul style="list-style-type: none"> In general (except for dual counter mode) Reads counting signals Increment, decrement, command, individual, and quadrature inputs accepted. When used as a dual counter Reads CP1 count signals with CP1 input and CP2 count signals with CP2 input. Increment signals can be input.
	Reset or Reset 1	<ul style="list-style-type: none"> In general (except for dual counter mode) Resets present value and outputs (OUT2 when using the batch counter). (See note 1.) Counting cannot be performed during reset/reset 1 input. The reset indicator is lit during reset input. When used as a dual counter Resets the CP1 present value (to 0). Counting for CP1 input cannot be performed during reset 1 input. The reset indicator is lit during reset 1 input.
	Total Reset or Reset 2 (See note 2.)	<ul style="list-style-type: none"> When used as a 1-stage/2-stage counter Does not operate (Not used). When used as a total and preset counter Resets the total count value. Holds the total count value at 0 during total reset input. When used as a batch counter Resets the batch count value and batch output (OUT1). Holds the batch count value at 0 during reset 2 input. When used as a dual counter Resets the CP2 present value. Counting for CP2 input cannot be performed during reset 2 input.
Outputs	OUT1, OUT2	Outputs take place according to designated output mode when corresponding preset is reached.

Note: 1. In increment mode or increment/decrement mode, the present value returns to 0; in decrement mode, the present value returns to the set value with 1-stage models, and returns to set value 2 with 2-stage models.

2. The reset indicator will not be lit when the total reset or reset 2 input is ON.

Using as a Tachometer

Inputs	CP1, CP2	Reads counting signals. (CP2 input is not available.)
	Reset 1, Reset 2	Holds the measurement value and outputs. (Reset 2 input is not available.) The reset indicator is lit during hold.
Outputs	OUT1, OUT2	Outputs signals according to the specified output mode when a set value is reached.

Terminal Arrangement

Confirm that the power supply meets specifications before use.

H7CX-A/-A4 1-stage Contact Output

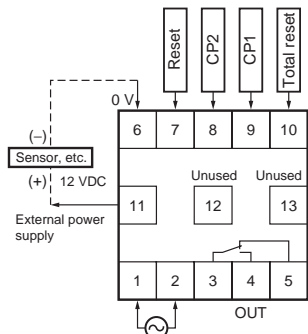

H7CX-AD/-A4D 1-stage Contact Output

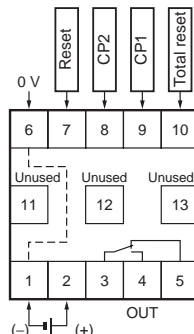

Note: Terminals 1 and 6 are connected internally.

H7CX-AS/-A4S 1-stage Transistor Output

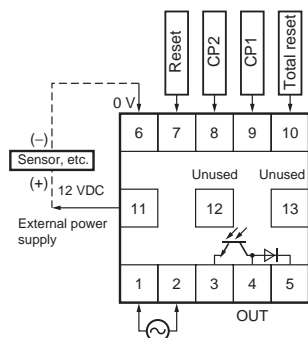

H7CX-ASD/-A4SD 1-stage Transistor Output

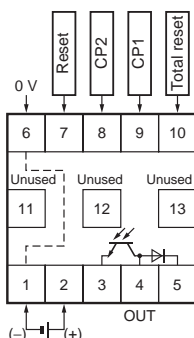

Note: Terminals 1 and 6 are connected internally.

H7CX-A11/-A114/-A11D1/-A114D1 1-stage Contact Output

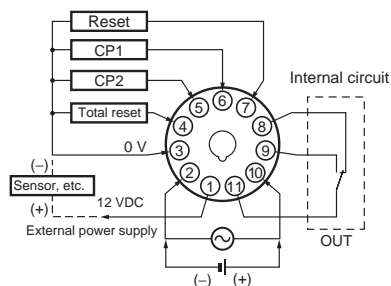

H7CX-A11S/-A114S/-A11SD1 1-stage Transistor Output

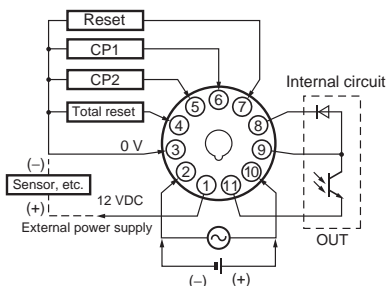

Note: Do not connect unused terminals as relay terminals.

H7CX-AW/-A4W/-AWD1
2-stage Contact Output

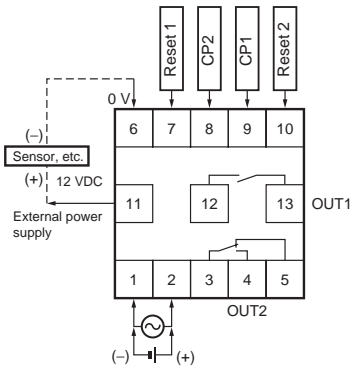

H7CX-AWS/-AWSD1
2-stage Transistor Output

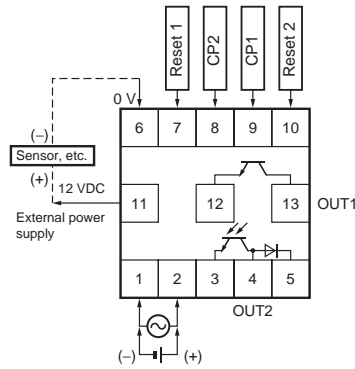

H7CX-AWSD/-A4WSD
2-stage Transistor Output

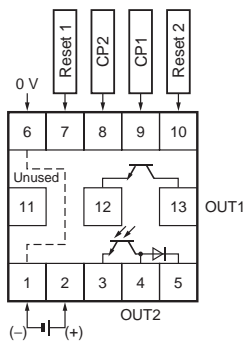

- Note:** 1. Terminals 1 and 6 are connected internally.
- 2. Do not connect unused terminals as relay terminals.

H7CX-AUSD1
1 or 2-stage Transistor Output

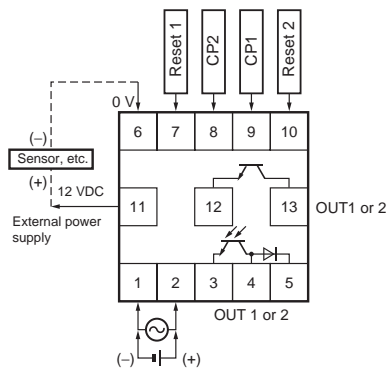

- Note:** Each output can be flexibly allocated to either stage 1 or 2 in function selection mode.

H7CX-AU/-AUD1
1-stage Contact, 1-stage Transistor Output

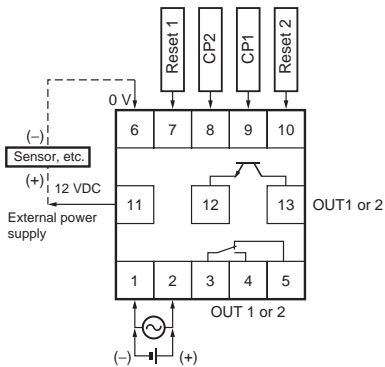

- Note:** Each output can be flexibly allocated to either stage 1 or 2 by setting in function selection mode.

■ **Input Circuits**

CP1, CP2, Reset/Reset 1, and Total Reset/Reset 2 Input

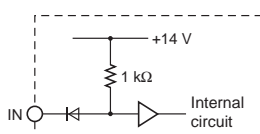

- Note:** The circuit shown above is for no-voltage input (NPN input).

Input Connections

The inputs of the H7CX are no-voltage (short-circuit or open) inputs or voltage inputs. When using as a tachometer, CP2 input and total reset/reset 2 input are not available.

No-voltage Inputs (NPN Inputs)

Open Collector

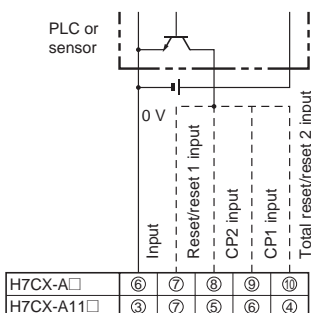

Operates when the transistor turns ON.

Voltage Output

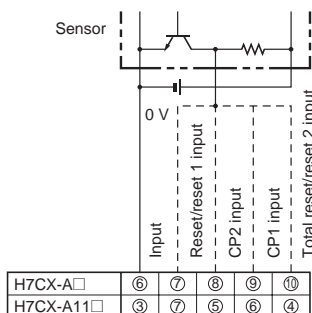

Operates when the transistor turns ON.

Contact Input

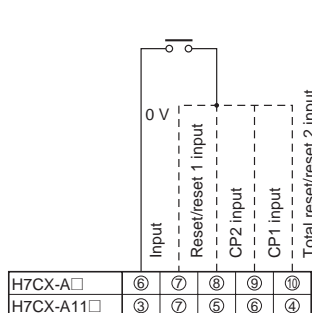

Operates when the contact turns ON.

DC Two-wire Sensor

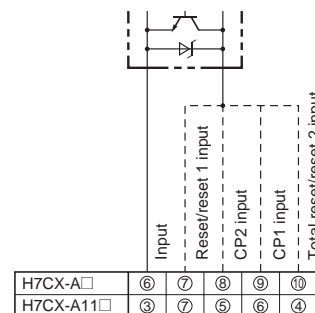

Operates when the transistor turns ON.

No-voltage Input Signal Levels

No-contact input	Short-circuit level Transistor ON Residual voltage: 3 V max. Impedance when ON: 1 kΩ max. (The leakage current is 5 to 20 mA when the impedance is 0 Ω)
	Open level Transistor OFF Impedance when OFF: 100 kΩ min.
Contact input	Use contact which can adequately switch 5 mA at 10 V. Maximum applicable voltage: 30 VDC max.

Applicable Two-wire Sensor

Leakage current: 1.5 mA max.
Switching capacity: 5 mA min.
Residual voltage: 3 VDC max.
Operating voltage: 10 VDC

Voltage Inputs (PNP Inputs)

No-contact Input (NPN Transistor)

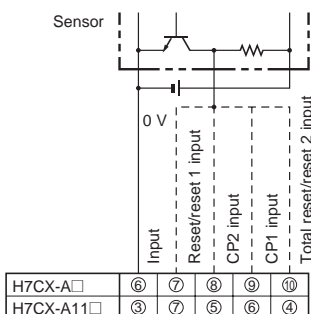

Operates when the transistor turns OFF.

No-contact Input (PNP Transistor)

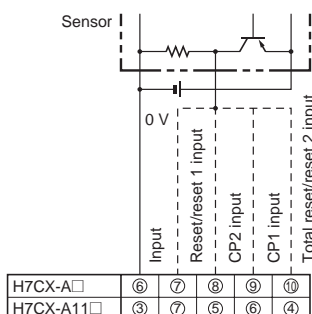

Operates when the transistor turns ON.

Contact Input

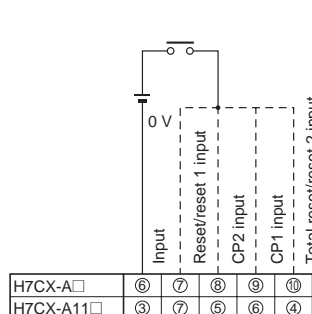

Operates when the contact turns ON.

Voltage Input Signal Levels

High level (Input ON): 4.5 to 30 VDC
Low level (Input OFF): 0 to 2 VDC
Maximum applicable voltage: 30 VDC max.
Input resistance: Approx. 4.7 kΩ

Nomenclature

Indicators

- ① Reset Indicator (Orange)
Lit when the reset input (1) or reset key is ON.

- ② Key Protection Indicator (Orange)

- ③ Control Output Indicator (Orange)
OUT: One stage
OUT1, OUT2: Two stages

- ④ Total Count Indicator
Lit when the total count value is displayed.

- ⑤ Batch Indicator
Lit when the batch count value is displayed.

- ⑥ Set Value 1, 2 Stage Indicator

- ⑦ Present Value (Main Display)
Character height: 11.5 mm (6-digit: 9mm)

- ⑧ Set Value (Sub-display)
Character height: 6 mm

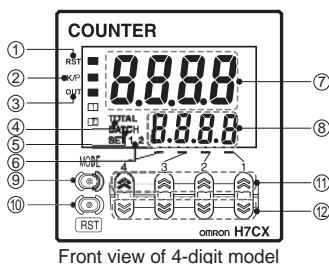

Front view of 4-digit model

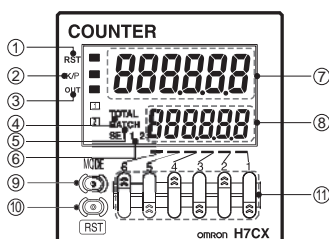

Front view of 6-digit model

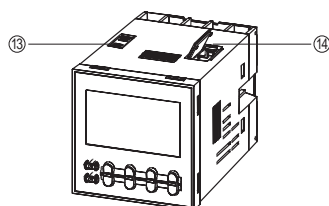

Operation Keys

- ⑨ Mode Key
Used to switch mode and setting items.

- ⑩ Reset Key
The operation of the reset function depends on the configuration selected as shown in the table below.

- ⑪ Up Keys: 1 to 4
(6-digit models: 1 to 6)

- ⑫ Down Keys: 1 to 4

Switches

- ⑬ Key Protect Switch

(Factory setting) OFF ← ON

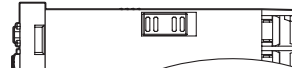

- ⑭ DIP Switch

Reset Operation by Reset Key

Configuration	Reset operation
1-stage/2-stage counter	Resets the present value and outputs.
Total and preset counter	<ul style="list-style-type: none"> • Resets the present value and outputs. • When the total count value is displayed, resets the present value, the total count value, and outputs.
Batch counter	<ul style="list-style-type: none"> • Resets the present value and OUT2. • When the batch count value is displayed, resets the present value, the batch count value, and outputs.
Dual counter	Resets the CP1 present value, CP2 present value, dual count value, and outputs.
Tachometer	Maintains the measured value and outputs (hold function).

Dimensions

Note: All units are in millimeters unless otherwise indicated.

Counter (without Flush Mounting Adapter)

Screw-terminal Models with External Power Supplies (Flush Mounting)

- H7CX-A
- H7CX-AS
- H7CX-A4
- H7CX-A4S
- H7CX-AW
- H7CX-AWS
- H7CX-A4W
- H7CX-AWD1
- H7CX-AWSD1
- H7CX-AU
- H7CX-AUD1
- H7CX-AUSD1

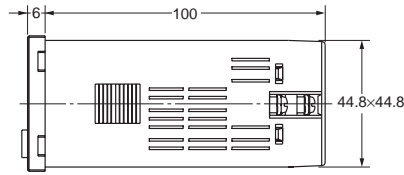
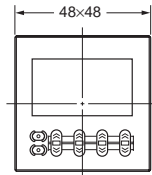
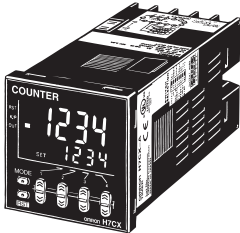

Note: M3.5 terminal screw (effective length: 6 mm)

Screw-terminal Models without External Power Supplies (Flush Mounting)

- H7CX-AD
- H7CX-ASD
- H7CX-A4D
- H7CX-A4SD
- H7CX-AWSD
- H7CX-AWSD

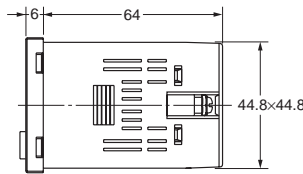
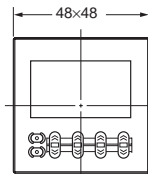

Note: M3.5 terminal screw (effective length: 6 mm)

11-pin Socket Models (Flush Mounting/Surface Mounting)

- H7CX-A11
- H7CX-A11S
- H7CX-A11D1
- H7CX-A11SD1
- H7CX-A114
- H7CX-A114S
- H7CX-A114D1

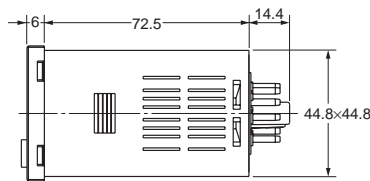
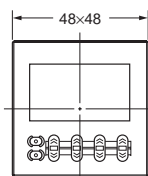

■ Dimensions with Flush Mounting Adapter

Screw-terminal Models with External Power Supplies (Provided with Adapter and Waterproof Packing)

- H7CX-A
- H7CX-AS
- H7CX-A4
- H7CX-A4S
- H7CX-AW
- H7CX-AWS
- H7CX-A4W
- H7CX-AWD1
- H7CX-AWSD1
- H7CX-AU
- H7CX-AUD1
- H7CX-AUSD1

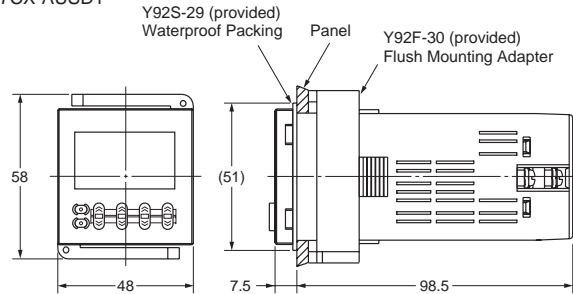
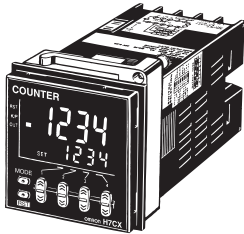

Panel Cutouts

Panel cutouts are as shown below.
(according to DIN43700).

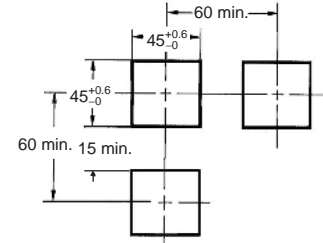

- Note:**
1. The mounting panel thickness should be 1 to 5 mm.
 2. To allow easier operability, it is recommended that Adapters are mounted so that the gap between sides with hooks is at least 15 mm (i.e., so that the panel cutout interval is at least 60 mm).
 3. It is possible to mount counters side by side, but only in the direction without the hooks. If they are mounted side-by-side, water-resistant specifications cannot be ensured.

Screw-terminal Models without External Power Supplies (Provided with Adapter and Waterproof Packing)

- H7CX-AD
- H7CX-ASD
- H7CX-A4D
- H7CX-A4SD
- H7CX-AWSD
- H7CX-A4WSD

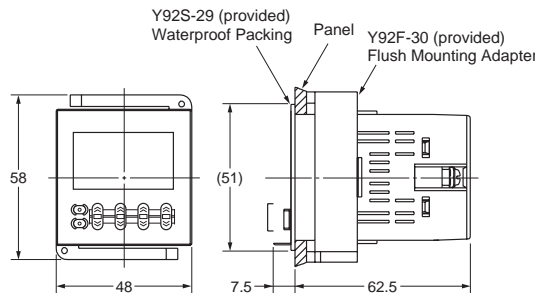

11-pin Socket Models (Adapter and Waterproof Packing Ordered Separately)

- H7CX-A11
- H7CX-A11S
- H7CX-A11D1
- H7CX-A11SD1
- H7CX-A114
- H7CX-A114S
- H7CX-A114D1

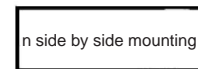
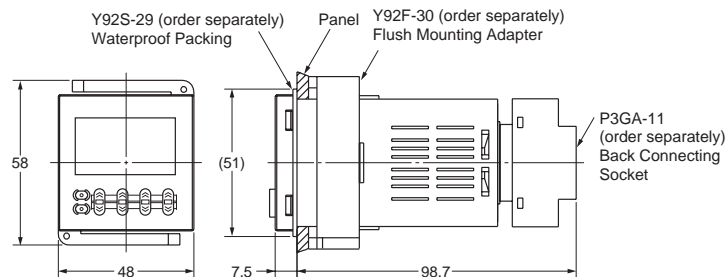
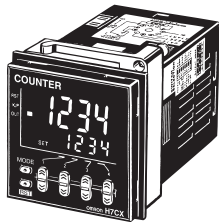

$$A = (48n - 2.5)_{-0}^{+1}$$

With Y92A-48F1 attached.
 $A = \{48n - 2.5 + (n-1) \times 4\}_{-0}^{+1}$

With Y92A-48 attached.
 $A = (51n - 5.5)_{-0}^{+1}$

■ Dimensions with Front Connecting Socket

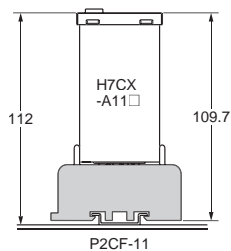

Note: These dimensions vary with the kind of DIN track (reference value).

■ Accessories (Order Separately)

Note: All units are in millimeters unless otherwise indicated.

Track Mounting/Front Connecting Socket P2CF-11

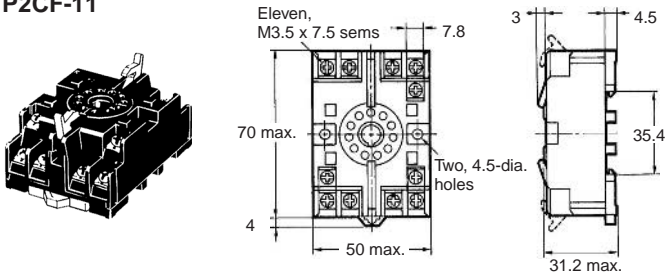

Terminal Arrangement/
Internal Connections
(Top View)

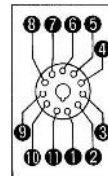

Surface Mounting Holes

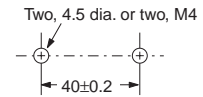

Note: Track mounting is also possible.

P2CF-11-E (Finger-safe Terminal Type) Conforming to VDE0106/P100

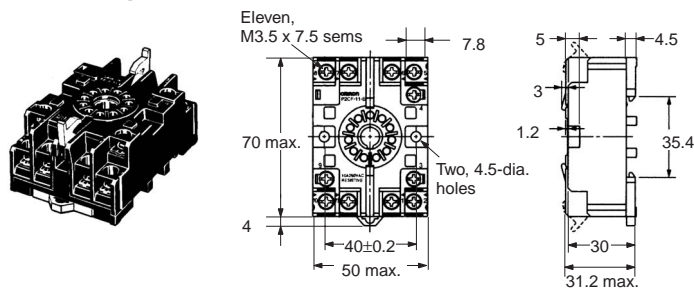

Back Connecting Socket P3GA-11

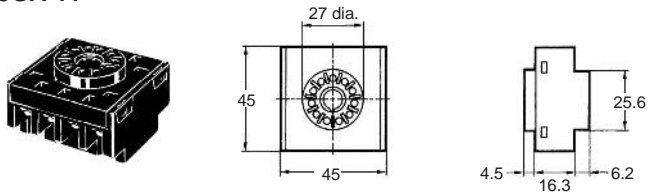

Terminal Arrangement/
Internal Connections
(Bottom View)

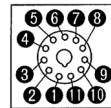

Note: Finger protection can be ensured by using in combination with the Y92A-48G Terminal Cover.

Finger-safe Terminal Cover Conforming to VDE0106/P100

Y92A-48G (Attachment for P3GA-11 Socket)

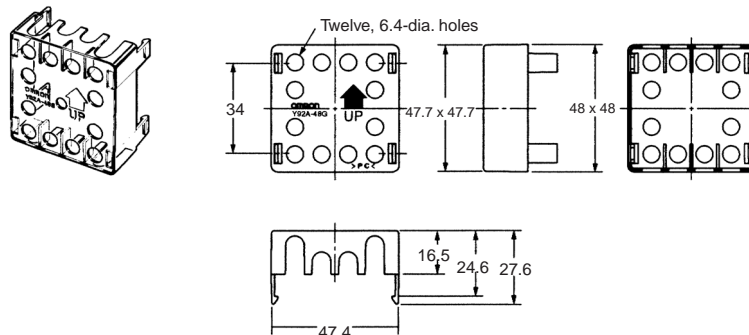

**Hard Cover
Y92A-48**

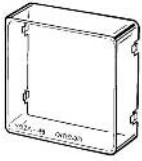

**Soft Cover
Y92A-48F1**

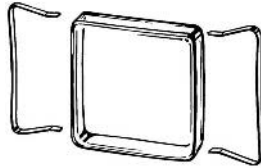

Note: 1. Depending on the operating environment, the condition of resin products may deteriorate, and may shrink or become harder. Therefore, it is recommended that resin products are replaced regularly.

2. The H7CX's panel surface is water-resistive (conforming to IP66) and so even if drops of water penetrate the gaps between the keys, there will be no adverse effect on internal circuits. If, however, there is a possibility of oil being present on the operator's hands, use the Soft Cover. The Soft Cover ensures protection equivalent to IP54F against oil. Do not, however, use the H7CX in locations where it would come in direct contact with oil.

**Flush Mounting Adapter
(provided with screw-terminal models)**

Y92F-30

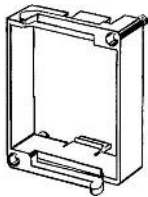

**Waterproof Packing
(provided with screw-terminal models)**

Y92S-29

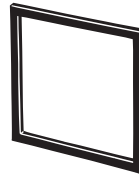

When using the Y92S-29, the degree of protection for the H7CX's panel surface conforms to NEMA4, UL Type 4X, and IP66. (Depending on the operating environment, the condition of the panel may deteriorate, shrink, or become harder. Therefore, regular replacement is recommended.)

**Mounting Track
PFP-100N, PFP-50N**

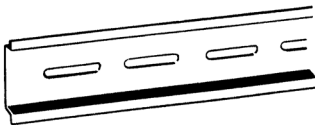

PFP-100N2

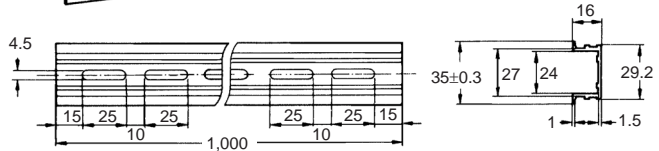
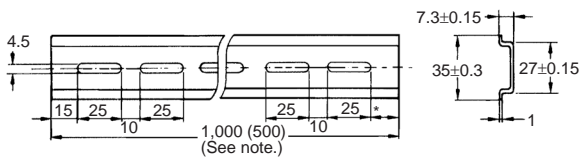
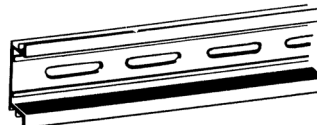

Note: The values shown in parentheses are for the PFP-50N.

**End Plate
PFP-M**

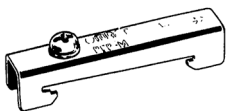

**Spacer
PFP-S**

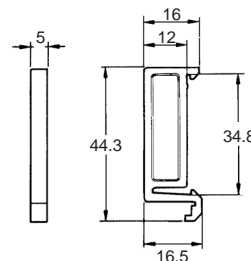
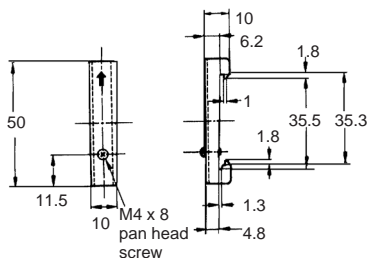
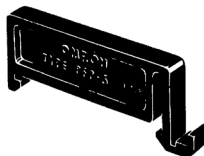

Operating Procedures

Setting Procedure Guide

Setting for Counter Operation

(1-stage/2-stage Counter, Total and Preset Counter, Batch Counter, Dual Counter)

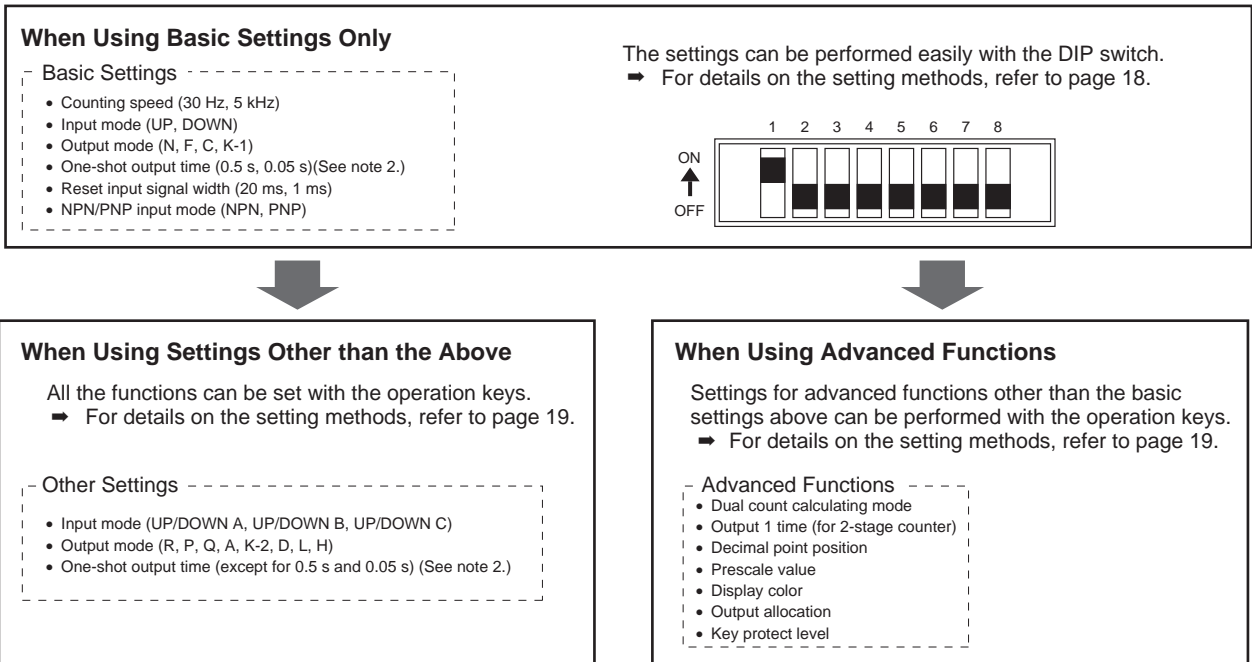

Note: 1. At the time of delivery, the H7CX is set to the 1-stage counter (2-stage counter for H7CX-AW□/-A4W□ models) configuration.
 2. Set to output 2 time when using as a 2-stage counter or batch counter.

Setting for Tachometer Operation

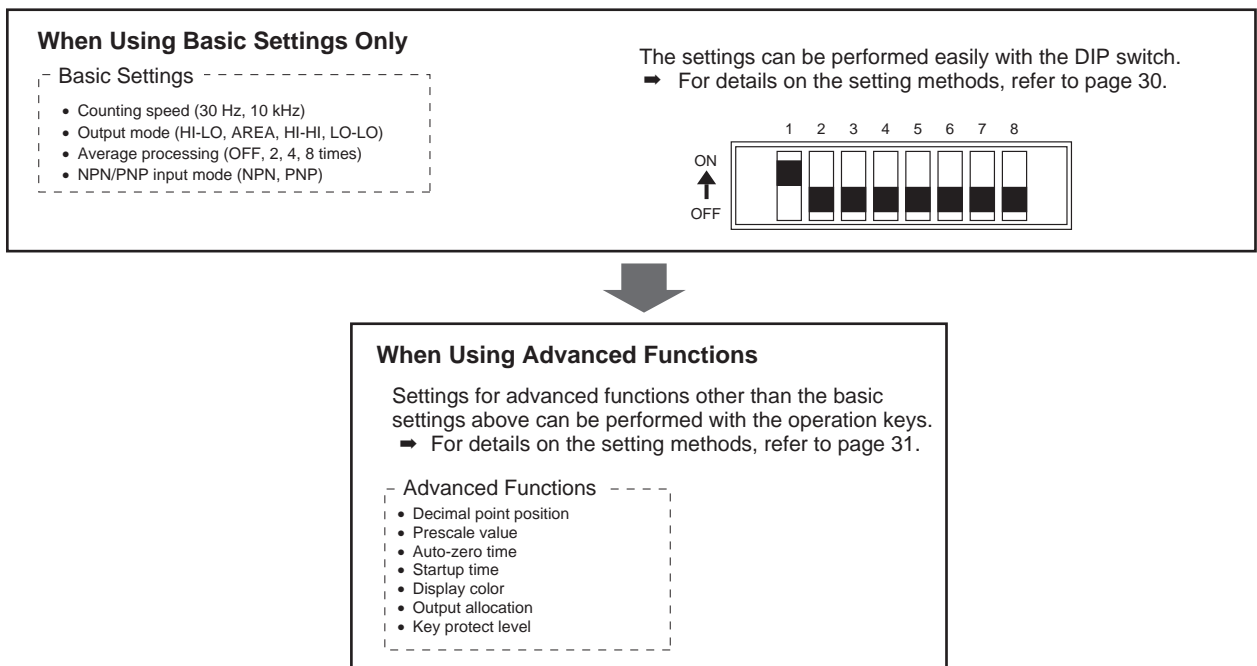

Note: At the time of delivery, the H7CX is set to the 2-stage counter (1-stage counter for H7CX-AU□ models) configuration.

■ Operating Procedures (Counter Function)

Settings for Basic Operations

Settings for basic functions can be performed with just the DIP switch.

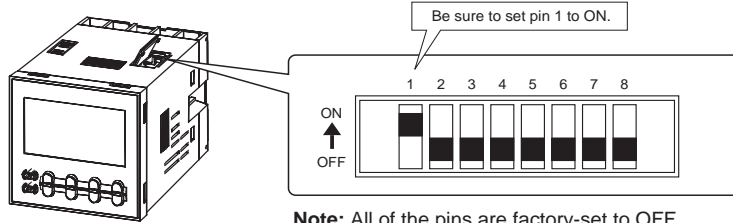

Note: All of the pins are factory-set to OFF.

Item	OFF	ON	
1	DIP switch settings enable/disable	Disabled	Enabled
2	Counting speed	30 Hz	5 kHz
3	Input mode	UP (increment)	DOWN (decrement)
4	Output mode	Refer to the table on the right.	
5			
6	One-shot output time (See note.)	0.5 s	0.05 s
7	Reset input signal width	20 ms	1 ms
8	NPN/PNP input mode	NPN	PNP

Pin 4	Pin 5	Output mode
OFF	OFF	N
ON	OFF	F
OFF	ON	C
ON	ON	K-1

Note: Set to one-shot output 2 time when using as a 2-stage counter or batch counter.

Easy Confirmation of Switch Settings Using Indicators

The ON/OFF status of the DIP switch pins can be confirmed using the front display. For details, refer to page 36.

- Note:
- Be sure to set pin 1 of the DIP switch to ON. If it is set to OFF, the DIP switch settings will not be enabled.
 - Changes to DIP switch settings are enabled when the power is turned ON.
 - When setting input modes, output modes, or output times that cannot be set with the DIP switch, all of the settings have to be made using the operation keys. For details on the setting methods, refer to page 19. When making settings using the operation keys, be sure to set pin 1 of the DIP switch to OFF.

Switching to Total and Preset Counter, Batch Counter, and Dual Counter Operation (See note.)

The H7CX is factory-set to the 1-stage counter (2-stage counter for H7CX-AW□/-A4W□ models) configuration. To change to a different configuration, use the procedure shown on the right. For details, refer to page 36.

Note: This includes changing to the 2-stage counter (or 1-stage counter) configuration.

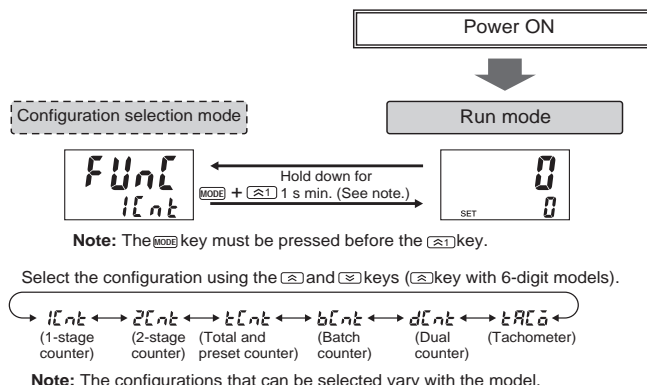

Advanced-Function Settings

After making DIP switch settings for basic operations, advanced functions (see note) can be added using the operation keys. For details, refer to page 19.

Note: Advanced functions consist of the dual count calculating mode, output 1 time (for 2-stage counter), decimal point position, prescale value, display color, output allocation, and key protect level.

Settings for All Functions

Note: At the time of delivery, the H7CX is set to the 1-stage counter (2-stage counter for H7CX-AW□/A4W□ models) configuration. When using as a 2-stage (or 1-stage) counter, total and preset counter, batch counter, or dual counter, switch to the configuration using the procedure given on page 36.

Settings that cannot be performed with the DIP switch are performed with the operation keys.

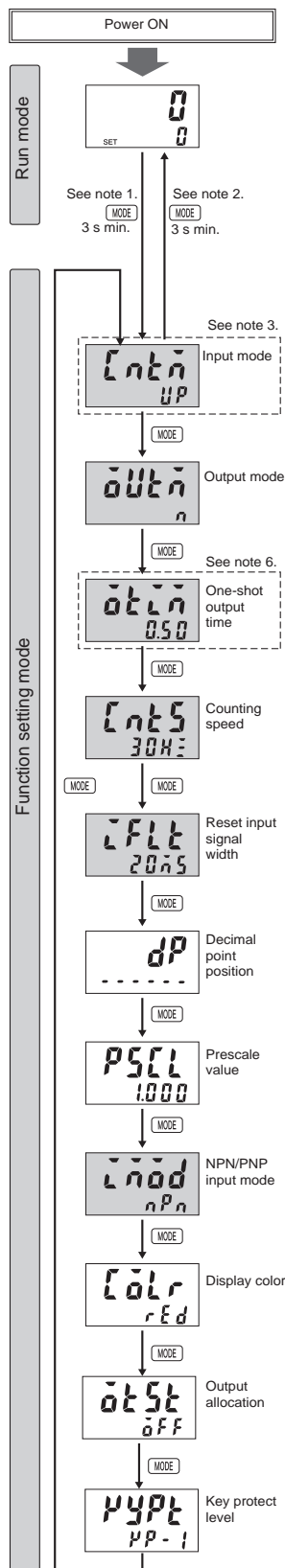

For details on operations and display in run mode, refer to page 22. The display depends on the configuration used.

- Note 1:** If the mode is switched to the function setting mode during operation, operation will continue.
- 2:** Changes made to settings in function setting mode are enabled for the first time when the mode is changed to run mode. Also, when settings are changed, the counter is reset (present value initialized and output turned OFF) on returning to run mode.

The characters displayed in reverse video are the default settings.

When performing settings with operation keys only, set pin1 of the DIP switch to OFF (factory setting). If pin 1 of the DIP switch is set to ON, the setting items indicated by ■ will not be displayed.

Set each setting item using the \leftarrow / \rightarrow keys. (\leftarrow key only for 6-digit models)

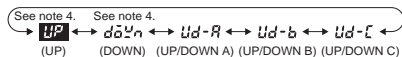

Note 4: Displayed for output modes other than K-2, D, L, and H only.

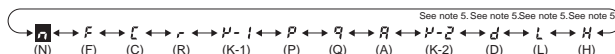

Note 5: Display only when the input mode is UP/DOWN A, B, or C with 6-digit models (with H7CX-AU□/AW□ models only for H).



Note: Displayed only when the output mode is C, R, K-1, P, Q, A, or K-2.

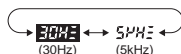

See note 7.

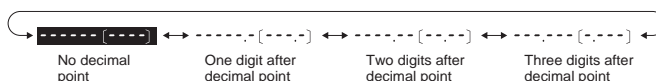

See note 7.

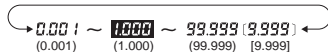

Note 6: When using as a 2-stage counter:

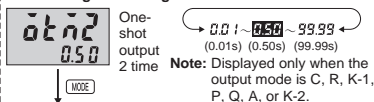

When using as a batch counter:

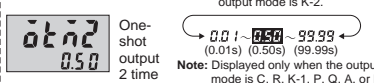

Note 7: The displays for 4-digit models are shown inside parentheses.

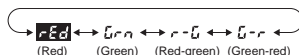
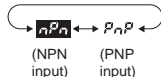

Note: Displayed for terminal-block models (except H7CX-A11□) only.



Note: Displayed for H7CX-AU□ models only.

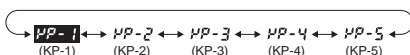

Note 3:

When using as a dual counter:

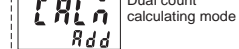

Note: Displayed only when the output mode is K-2, D, L, or H.

Explanation of Functions

Input Mode ($\overline{C}n\overline{L}\overline{n}$) (Setting possible using DIP switch.)

Set increment mode (UP), decrement mode (DOWN), or one of the increment/decrement modes (UP/DOWN A, UP/DOWN B, or UP/DOWN C) as the input mode. Input modes other than UP or DOWN modes cannot be set using the DIP switch and so use the operation keys if other modes are required. (For details on the operation of the input modes, refer to *Input Modes and Present Value* on page 23.)

Dual Count Calculating Mode ($\overline{C}AL\overline{n}$)

When using as a dual counter, select either ADD (addition) or SUB (subtraction) as the calculation method for the dual count value. SUB mode can be used only when K-2, D, L, or H is selected as the output mode with 6-digit models.

ADD: Dual count value = CP1 PV + CP2 PV

SUB: Dual count value = CP1 PV – CP2 PV

Output Mode ($\overline{a}L\overline{n}$) (Setting possible using DIP switch.)

Set the way that control output for the present value is output. The possible settings are N, F, C, R, K-1, P, Q, A, K-2, D, L, and H. Output modes other than N, F, C, or K-1 cannot be set using the DIP switch and so use the operation keys if other modes are required. The output modes that can be set vary with the model. (For details on the operation of the output modes, refer to *Input/Output Mode Settings* on page 24.)

One-shot Output Time ($\overline{a}L\overline{n}2$) (Setting possible using DIP switch.)

Set the one-shot output time (0.01 to 99.99 s) for control output. One-shot output can be used only when C, R, K-1, P, Q, A, or K-2 is selected as the output mode. Output times other than 0.5 s or 0.05 s cannot be set with the DIP switch and so use the operation keys if other settings are required.

One-shot Output 2 Time ($\overline{a}L\overline{n}2$) (Setting possible using DIP switch.)

When using as a 2-stage counter or batch counter, set the one-shot output time (0.01 to 99.99 s) for control output (OUT2). One-shot output can be used only when C, R, K-1, P, Q, A, or K-2 is selected as the output mode. Output times other than 0.5 s or 0.05 s cannot be set with the DIP switch and so use the operation keys if other settings are required.

One-shot Output 1 Time ($\overline{a}L\overline{n}1$)

When using as a 2-stage counter, set the one-shot output time (0.01 to 99.99 s) for control output (OUT1). One-shot output can be used only when D, L, or H is selected as the output mode. If the output time is set to 0.00, $\overline{H}o\overline{L}d$ is displayed, and outputs are held. HOLD cannot be set when the output mode is K-2.

Counting Speed ($\overline{C}n\overline{L}5$) (Setting possible using DIP switch.)

Set the maximum counting speed (30 Hz/5 kHz) for CP1 and CP2 inputs together. If contacts are used for input signals, set the counting speed to 30 Hz. Processing to eliminate chattering is performed for this setting.

Reset Input Signal Width ($\overline{C}FL\overline{L}$) (Setting possible using DIP switch.)

Set the reset input signal width (20 ms/1 ms) for reset/reset 1 and total reset/reset 2 inputs together. If contacts are used for input signals, set the counting speed to 20 ms. Processing to eliminate chattering is performed for this setting.

Decimal Point Position (dP)

Decide the decimal point position for the present value, CP1/CP2 present values, set value (SV1, SV2), total count value, and dual count set value.

Prescale Value ($P5\overline{C}L$)

Pulses input to the counter are converted according to the specified prescale value. (Setting range: 0.001 to 99.999 for 6-digit models and 0.001 to 9.999 for 4-digit models.)

Example: To display the feed distance for systems that output 25 pulses for a feed length of 0.5 m in the form $\square\square.\square\square$ m:

1. Set the decimal point position to 2 decimal places.
2. Set the prescale value to 0.02 (0.5÷25).

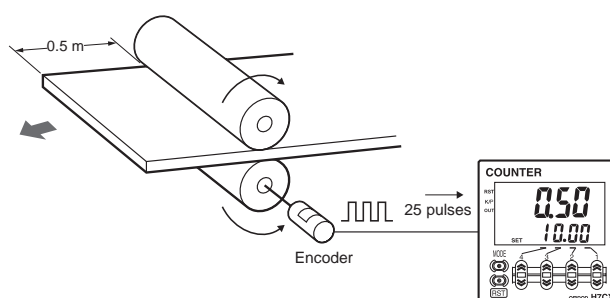

NPN/PNP Input Mode ($\overline{C}n\overline{a}d$)

Select either NPN input (no-voltage input) or PNP input (voltage input) as the input format. The same setting is used for all external inputs. For details on input connections, refer to *Input Connections* on page 11.

Display Color ($\overline{C}a\overline{L}r$)

Set the color used for the present value.

	Output OFF (See note.)	Output ON (See note.)
$\overline{r}Ed$	Red (fixed)	
$\overline{G}rn$	Green (fixed)	
$\overline{r}-\overline{G}$	Red	Green
$\overline{G}-r$	Green	Red

Note: When using as a 2-stage counter, this is the status of output 2.

Output Allocation ($\overline{a}L5\overline{L}$)

When using H7CX-AU□ models as a 2-stage counter, the output can be flexibly allocated to either stage 1 or 2. Transistor output can be allocated to SV1 and contact output for SV2 or vice versa, as in the following table.

H7CX-AU/AUD1

	OUT1	OUT2
$\overline{a}FF$	Transistor (12-13)	Contact (3, 4, 5)
$\overline{a}n$	Contact (3, 4, 5)	Transistor (12-13)

H7CX-AUSD1

	OUT1	OUT2
$\overline{a}FF$	Transistor (12-13)	Transistor with diode (3, 4, 5)
$\overline{a}n$	Transistor with diode (3, 4, 5)	Transistor (12-13)

Key Protect Level (K_YP_L)

Set the key protect level.

When the key-protect switch is set to ON, it is possible to prevent setting errors by prohibiting the use of certain operation keys by specifying the key protect level (KP-1 to KP-5). The key protect indicator is lit while the key-protect switch is set to ON. Confirm the ON/OFF status of the key-protect switch after the H7CX is mounted to the panel.

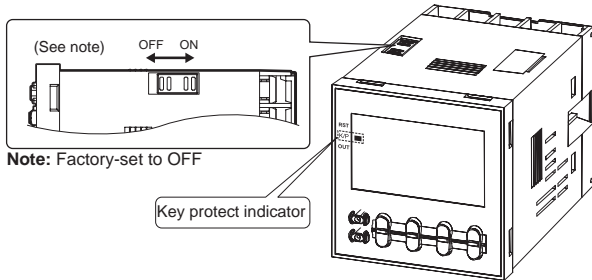

Level	Meaning	Details			
		Changing mode (See note.)	Switching display in run mode	Reset key	Up/down key (Up key for 6-digit models)
KP-1 (default setting)		No	Yes	Yes	Yes
KP-2		No	Yes	No	Yes
KP-3		No	Yes	Yes	No
KP-4		No	Yes	No	No
KP-5		No	No	No	No

Note: Changing mode to configuration selection mode (MODE + 1 s min.) or function setting mode (MODE 3 s min.).

Operation in Run Mode

Set values for each digit as required using the \uparrow and \downarrow keys. (\uparrow key only for 6-digit models.)



1-stage Counter

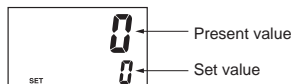

Present Value

Shows the present count value.

Set Value (Set Value 1, Set Value 2)

Set the set value. When the present value reaches the set value, signals are output according to the specified output mode.

2-stage Counter

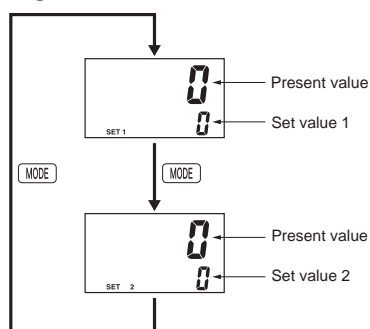

Total and Preset Counter

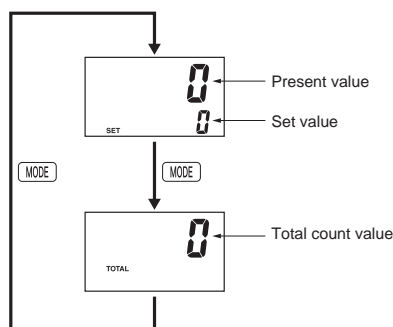

Present Value/Set Value

Same as 1-stage counter.

Total Count Value

Shows the present total count value.

Batch Counter

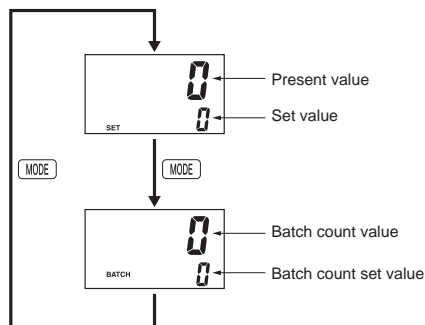

Present Value/Set Value

Same as 1-stage counter.

Batch Count Value

Shows the number of times the count has been completed for the present value.

Batch Count Set Value

Set the batch count set value. When the batch count value reaches the batch count set value, batch output (OUT1) turns ON.

Dual Counter

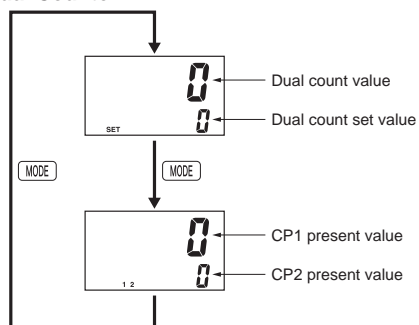

Dual Count Value

Shows the sum of the CP1 present value and CP2 present value when the dual count calculating mode is ADD and shows the value obtained by subtracting the CP2 present value from the CP1 present value when the dual count calculating mode is SUB.

Dual Count Set Value

Set the dual count set value. When the dual count value reaches the dual count set value, signals are output according to the specified output mode.

CP1/CP2 Present Value

Show the present count values for CP1 and CP2 present values respectively.

Input Modes and Present Value

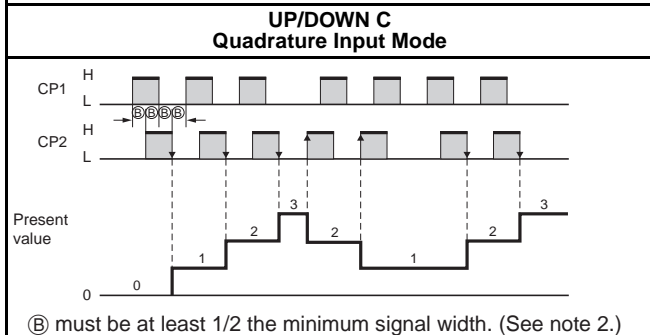
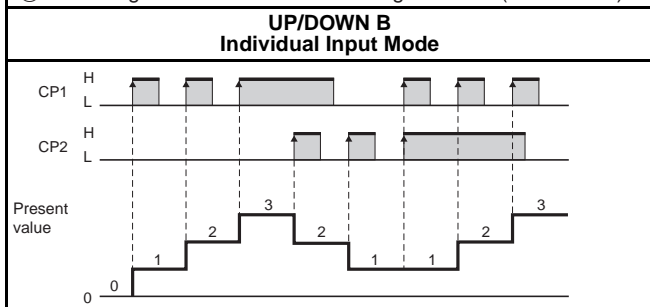
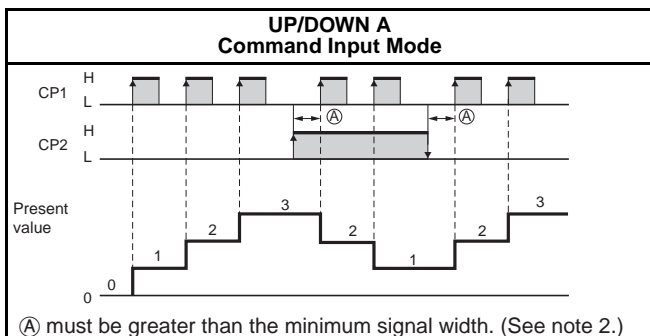
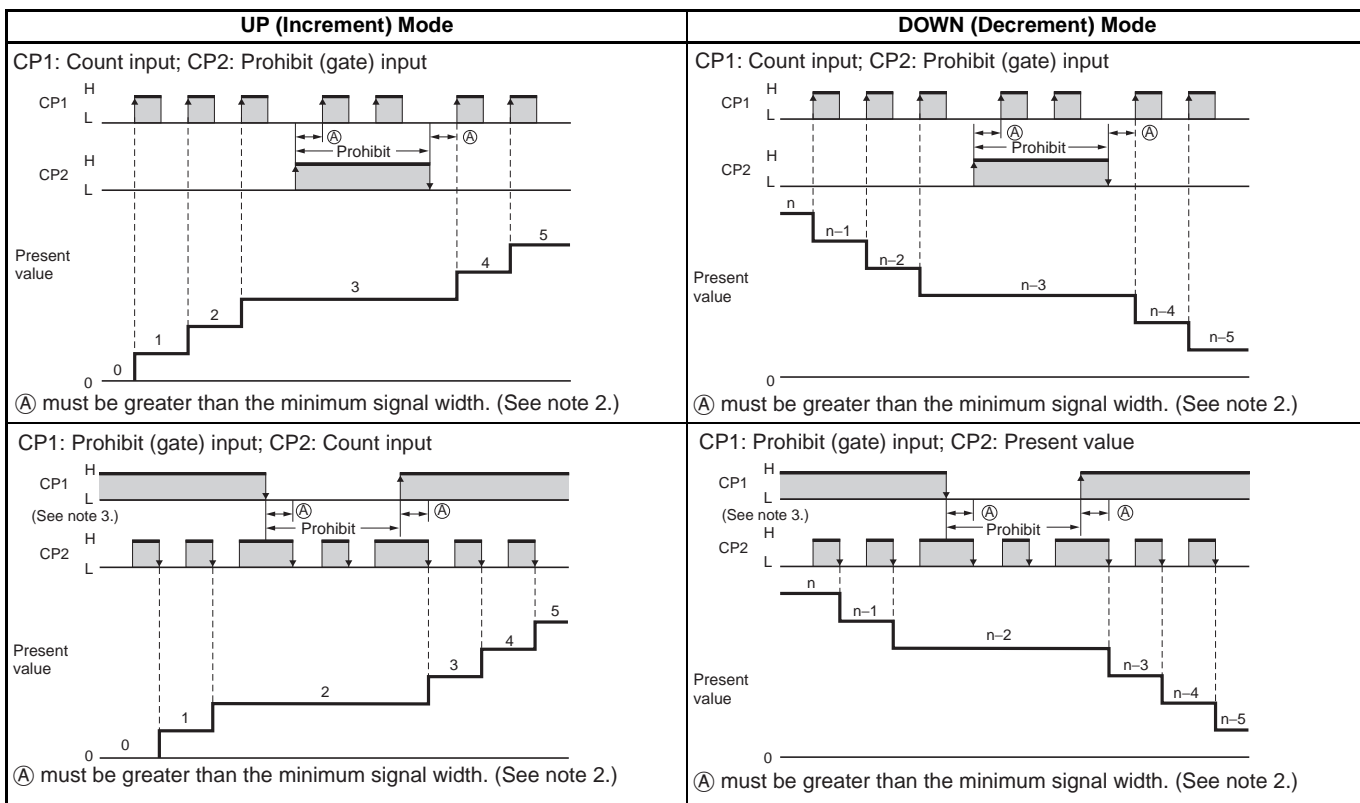

- Note: 1.** If the configuration selection is set to dual counter, CP1 and CP2 input will operate in the same way as the count input (CP1) of UP (increment) mode.
- 2.** Ⓐ must be greater than the minimum signal width and Ⓑ must be at least 1/2 the minimum signal width. If they are less, a count error of ±1 may occur.
 Minimum signal width: 16.7 ms (when maximum counting speed = 30 Hz)
 100 μs (when maximum counting speed = 5 kHz)
- 3.** Counting starts when the CP1 is turned ON after turning ON the power.
- 4.** The meaning of the H and L symbols in the tables is explained below.

Input method Symbol	No-voltage input (NPN input)	Voltage input (PNP input)
H	Short-circuit	4.5 to 30 VDC
L	Open	0 to 2 VDC

Input/Output Mode Settings

Operation for 1-stage models is the same as that for OUT2.

When using a 2-stage model as a 1-stage counter, total and preset counter, or dual counter, OUT1 and OUT2 turn ON and OFF simultaneously.

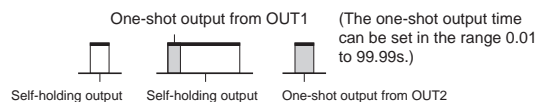

Output mode setting	Input mode			Operation after count completion
	UP	DOWN	UP/DOWN A, B, C	
N				The outputs and present value display are held until reset/reset 1 is input.
F				The present value display continues to increase/decrease. The outputs are held until reset/reset 1 is input.
C				As soon as the count reaches SV, the present value display returns to the reset start status. The present value display does not show the present value upon count-up. The outputs repeat one-shot operation. OUT1 self-holding output turns OFF after the OUT2 one-shot output time. The OUT1 one-shot output time is independent of OUT2.
R				The present value display returns to the reset start status after the one-shot output time. The outputs repeat one-shot operation. OUT1 self-holding output turns OFF after the OUT2 one-shot output time. The OUT1 one-shot output time is independent of OUT2.

- Note:**
1. The full scale (FS) for H7CX 4-digit models is 9999.
 2. When the present value reaches 999999, it returns to 0.
 3. Counting cannot be performed during reset/reset 1 input.
 4. If reset/reset 1 is input while one-shot output is ON, one-shot output turns OFF.
 5. If there is power failure while output is ON, output will turn ON again when the power supply has recovered. For one-shot output, output will turn ON again for the duration of the output time setting once the power supply has recovered.
 6. Do not use the counter function in applications where the count may be completed (again) while one-shot output is ON.

Output mode setting	K-1	Input mode			Operation after count completion
		UP	DOWN	UP/DOWN A, B, C	
Output mode setting	K-1				The present value display continues to increase/decrease. OUT1 self-holding output turns OFF after the OUT2 one-shot output time. The OUT1 one-shot output time is independent of OUT2.
	P				The present value display does not change during the one-shot output time period, but the actual count returns to the reset start status. The outputs return to the one-shot start state and repeat one-shot operation. OUT1 self-holding output turns OFF after the OUT2 one-shot output time. The OUT1 one-shot output time is independent of OUT2.
	Q				The present value continues to increase/decrease for the one-shot output time, but returns to the reset start status after the one-shot output time has elapsed. The outputs repeat one-shot operation. OUT1 self-holding output turns OFF after the OUT2 one-shot output time. The OUT1 one-shot output time is independent of OUT2.
	A				The present value display and OUT1 self-holding output is held until reset/reset 1 is input. OUT1 and OUT2 are independent.

- Note:**
1. The full scale (FS) for H7CX 4-digit models is 9999.
 2. When the present value reaches 999999, it returns to 0.
 3. Counting cannot be performed during reset/reset 1 input.
 4. If reset/reset 1 is input while one-shot output is ON, one-shot output turns OFF.
 5. If there is power failure while output is ON, output will turn ON again when the power supply has recovered. For one-shot output, output will turn ON again for the duration of the output time setting once the power supply has recovered.
 6. Do not use the counter function in applications where the count may be completed (again) while one-shot output is ON.

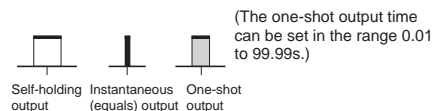

		Input mode UP/DOWN A, B, C	Operation after count completion
Output mode setting	K-2		The display continues to increase/decrease until the overflow or underflow value is reached. One-shot output only.
	D		The display continues to increase/decrease until the overflow or underflow value is reached. The outputs are ON while the count is equal.
	L		The display continues to increase/decrease until the overflow or underflow value is reached. OUT1 is held while the present value is less than or equal to set value 1. OUT2 is held while the present value is greater than or equal to set value 2.
	H		The display continues to increase/decrease until the overflow or underflow value is reached. OUT1 is held while the present value is greater than or equal to set value 1. OUT2 is held while the present value is greater than or equal to set value 2. Note: H mode is available only when using a 6-digit model as a 2-stage counter.

- Note:**
- Counting cannot be performed during reset/reset 1 input.
 - If reset/reset 1 is input while one-shot output is ON, one-shot output turns OFF.
 - If there is power failure while output is ON, output will turn ON again when the power supply has recovered. For one-shot output, output will turn ON again for the duration of the output time setting once the power supply has recovered.
 - Do not use the counter function in applications where the count may be completed (again) while one-shot output is ON.

Total and Preset Counter Operation

The H7CX has a total counter, separate from the 1-stage preset counter, for counting the total accumulated value.

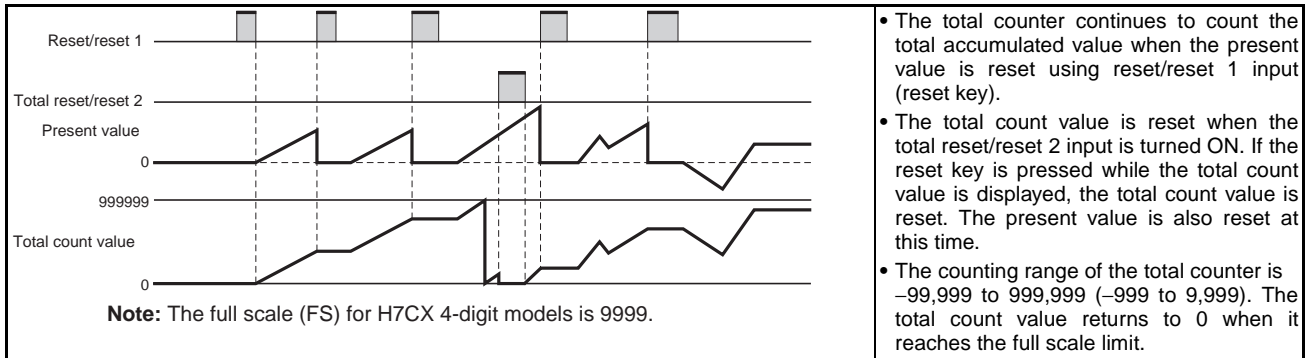

Batch Counter Operation

The H7CX has a batch counter, separate from the 1-stage preset counter, for counting the number of times the count has been completed.

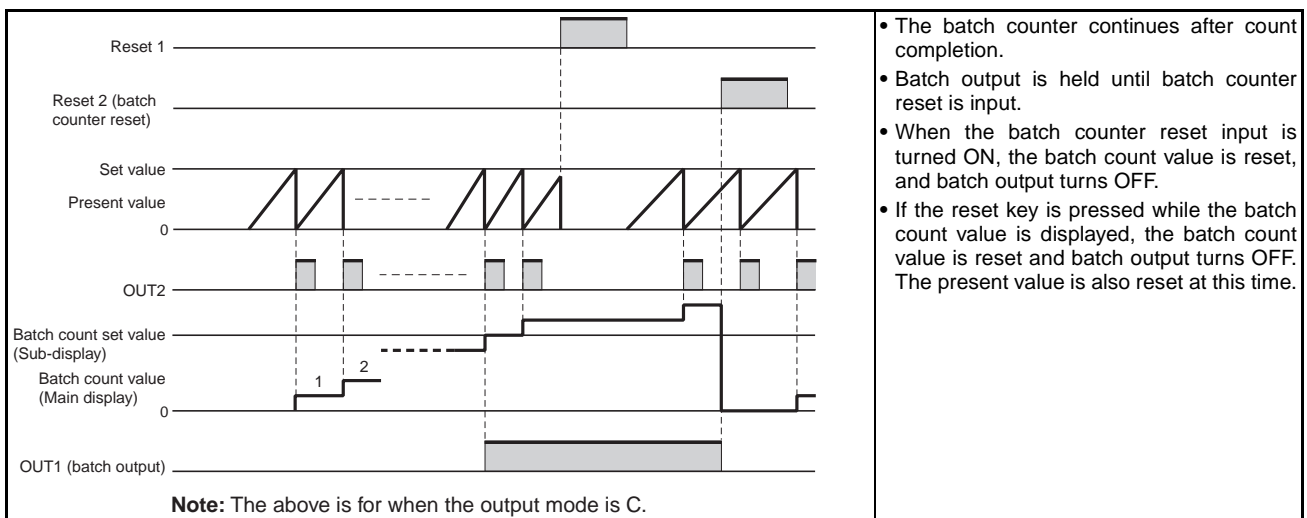

- Note:**
1. The batch count value is held at 0 during batch counter reset input.
 2. If the batch count set value is 0, batch count will be performed but there will be no batch output.
 3. The batch count value returns to 0 when it reaches 999,999 (9,999 for 4-digit models).
 4. Once batch input has been turned ON, it will return to the ON state after power interruptions.
 5. If the batch count set value is changed from a value that is greater than the batch count value to one that is less, batch output will turn ON.
 6. After batch output turns ON, the ON state will be held even if the batch count set value is changed to a value greater than the batch count value.

Dual Counter Operation

Using the dual counter allows the count from 2 inputs to be added or subtracted and the result displayed. It is possible to specify a set value for which output turns ON when the set value matches the added or subtracted result. OUT1 and OUT2 turn ON and OFF simultaneously.

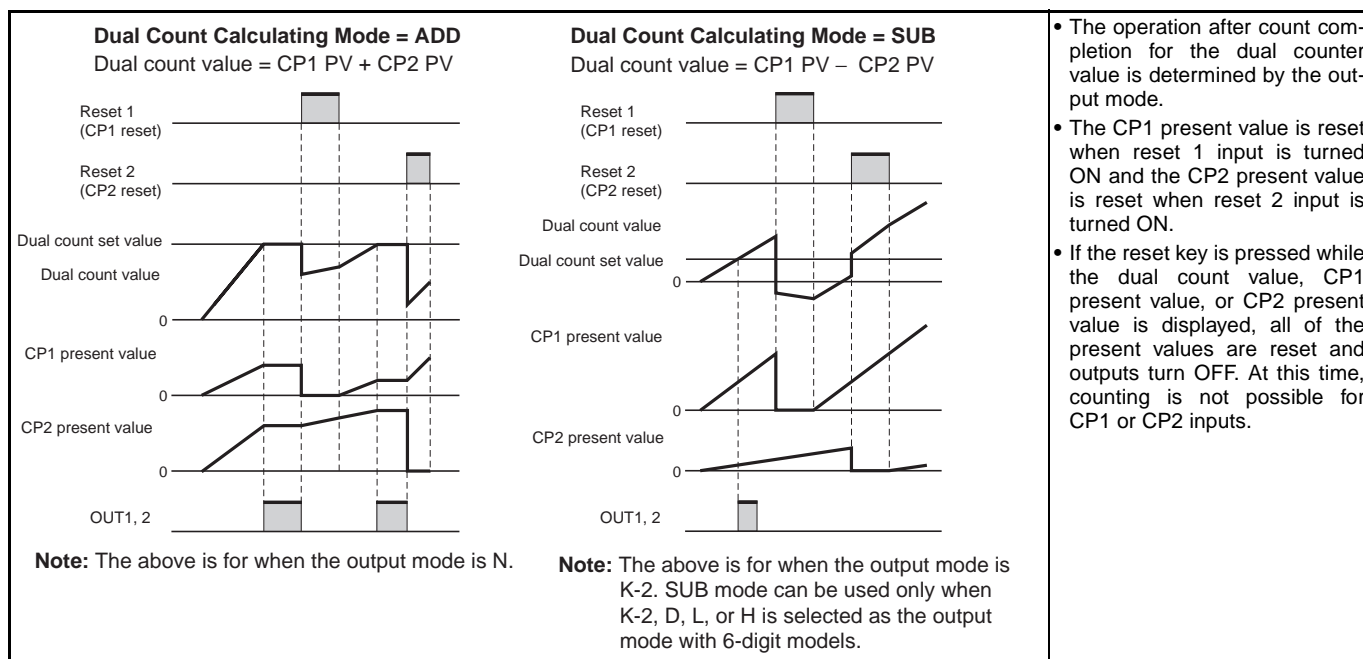

- Note:**
1. Counting is not possible for CP1 during reset 1 input. CP2 will not be affected. The dual count value will be calculated based on a CP1 present value of 0.
 2. Counting is not possible for CP2 during reset 2 input. CP1 will not be affected. The dual count value will be calculated based on a CP2 present value of 0.
 3. The counting range for the dual count value is -99,999 to 999,999 (0 to 9,999 for 4-digit models). The counting ranges for the CP1 present value and CP2 present value are 0 to 999,999 (0 to 9,999 for 4-digit models). If a present value exceeds 999,999 (9,999 for 4-digit models), FFFFFFFF (FFFF for 4-digit models) will be displayed to indicate an overflow, and all counting will stop.

Reset Function List

Function	1-stage/2-stage counter	Total and preset counter		Batch counter		Dual counter	
		Present value/set value (1, 2)	Present value/set value	Total count value	Present value/set value	Batch count value/batch count set value	Dual count value/dual count set value
Reset/reset 1	Present value and output reset.	Present value and output reset.		Present value and output reset.		Only the CP1 present value is reset.	
Total reset/reset 2	No effect.	Only the total count value is reset.		Batch count value and batch output reset.		Only the CP2 present value is reset.	
Reset key	Present value and output reset.	Present value and output reset.	Present value, total count value, and output reset.	Present value and output reset.	Present value, batch count value, output and batch output reset.	CP1 present value, CP2 present value, dual count value, and output reset.	

Self-diagnostic Function

The following displays will appear if an error occurs.

Main display	Sub-display	Error	Output status	Correction method	Set value after reset
----- (----) (See notes 1 and 2.)	No change	Present value underflow (See note 3.)	No change	Either press the reset key or turn ON reset input.	No change
FFFFFF (FFFF) (See notes 1 and 2.)	No change	Present value overflow (See note 4.)	No change	Either press the reset key or turn ON reset input.	No change
E1	Not lit	CPU	OFF	Either press the reset key or reset the power supply.	No change
E2	Not lit	Memory error (RAM)	OFF	Reset the power supply.	No change
E2	5U \bar{n}	Memory error (EEP) (See note 5.)	OFF	Reset to the factory settings using the reset key.	0

- Note:**
- The display for 4-digit models is given in parentheses.
 - Display flashes (1-second cycles).
 - Occurs when the present value or the total count value goes below -99,999 (-999 with 4-digit models).
 - Occurs when the present value reaches 999,999 (9,999 with 4-digit models) under the following conditions:
 - The output mode is K-2, D, L, or H.
 - The H7CX is set for dual counter operation.
 - Includes the case where the EEPROM has reached its overwrite lifetime.

■ Operating Procedures (Tachometer Function)

Switching from Counter to Tachometer

The H7CX is factory-set to the 2-stage counter (1-stage counter for H7CX-AU□ models) configuration. To switch to the tachometer configuration, use the procedure shown on the right. For details, refer to page 36.

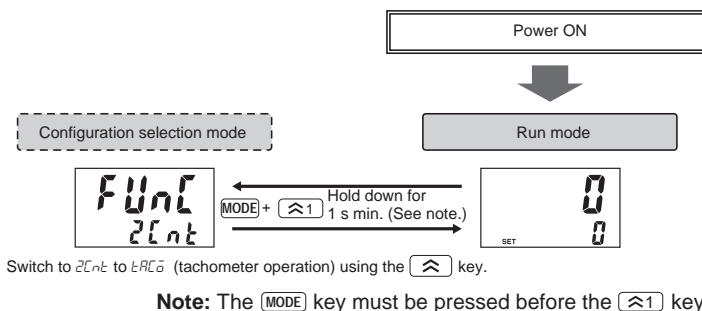

Settings for Basic Operations

Settings for basic functions can be performed with just the DIP switch.

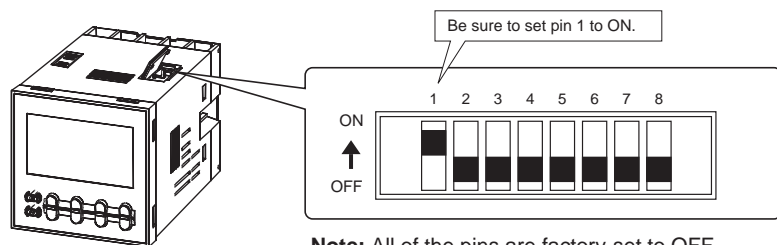

Note: All of the pins are factory-set to OFF.

Item	OFF	ON
1	DIP switch settings enable/disable	Disabled Enabled
2	Counting speed	30 Hz 10 kHz
3	Tachometer output mode	Refer to the table on the right.
4	Average processing	Refer to the table on the right.
7	Not used	---
8	NPN/PNP input mode	NPN PNP

Pin 3	Pin 4	Tachometer output mode
OFF	OFF	Upper and lower limit
ON	OFF	Area
OFF	ON	Upper limit
ON	ON	Lower limit

Pin 5	Pin 6	Average processing
OFF	OFF	OFF (no average processing)
ON	OFF	2 times
OFF	ON	4 times
ON	ON	8 times

Easy Confirmation of Switch Settings Using Indicators

The ON/OFF status of the DIP switch pins can be confirmed using the front display. For details, refer to page 36.

- Note:
1. Be sure to set pin 1 of the DIP switch to ON. If it is set to OFF, the DIP switch settings will not be enabled.
 2. Changes to DIP switch settings are enabled when the power is turned ON.

Advanced-Function Settings

After making DIP switch settings for basic operations, advanced-functions (see note) can be added using the operation keys. For details, refer to page 31.

Note: Advanced functions consist of decimal point position, prescale value, auto-zero time, startup time, display color, output allocation, and key protect level.

Settings for Advanced Functions

Note: When using as a tachometer, switch to the tachometer configuration using the procedure given on page 36.

Settings that cannot be performed with the DIP switch are performed with the operation keys.

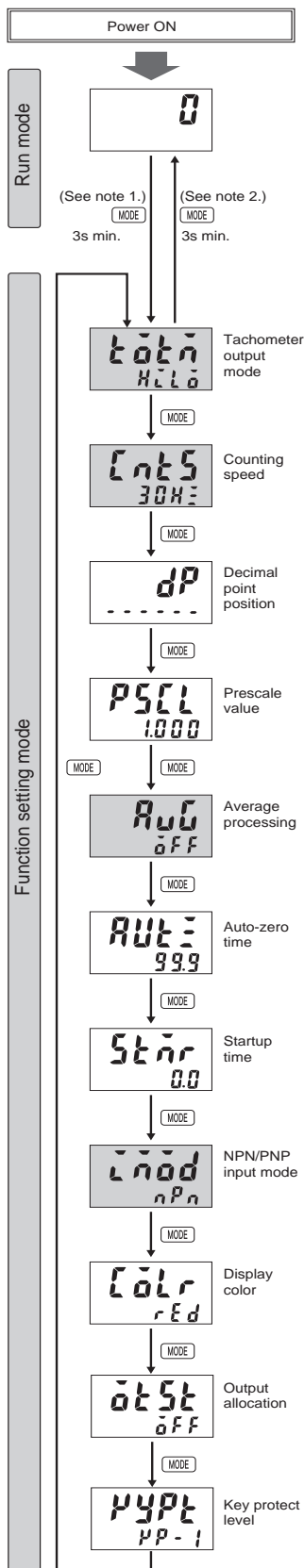

Note: 1. If the mode is switched to the function setting mode during operation, operation will continue.
 2. Changes made to settings in function setting mode are enabled for the first time when the mode is changed to run mode. Also, when settings are changed, the counter is re-set (measured values initialized and output turned OFF) on returning to run mode.

For details on operations in run mode, refer to page 34.

The characters displayed in reverse video are the initial values.
 When performing settings with operation keys only, set pin1 of the DIP switch to OFF (factory setting). If pin 1 of the DIP switch is set to ON, the setting items indicated by will not be displayed.

Set each setting item using the \leftarrow keys.

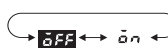
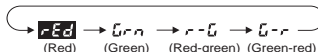
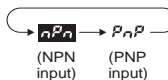
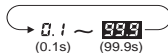
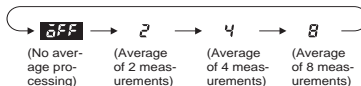
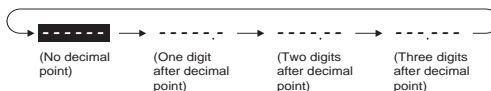
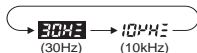
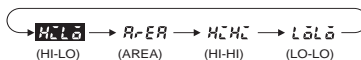

Note: Displayed for H7CX-AU□ models

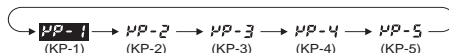

Explanation of Functions

Tachometer Output Mode ($\overline{L} \overline{O} \overline{L} \overline{O}$) (Setting possible using DIP switch.)

Set the output method for control output based on the OUT1/OUT2 set value. Upper and lower limit (HI-LO), area (AREA), upper limit (HI-HI), and lower limit (LO-LO) can be set. (For details on the operation of the output modes, refer to *Output Mode Settings* on page 35.)

Counting Speed ($\overline{L} \overline{N} \overline{L} \overline{S}$) (Setting possible using DIP switch.)

Set the maximum counting speed (30 Hz/10 kHz) for CP1 input. If contacts are used for input signals, set the counting speed to 30 Hz. Processing to eliminate chattering is performed for this setting.

Decimal Point Position (dP)

Decide the decimal point position for the measurement value, OUT1 set value, and OUT2 set value.

Prescale Value ($P5CL$)

It is possible to display the rate of rotation or the speed of a device or machine to which the H7CX is mounted by converting input pulses to a desired unit. If this prescaling function is not used, the input frequency (Hz) will be displayed.

The relationship between display and input is determined by the following equation. Set the prescale value according to the unit to be displayed.

$$\text{Displayed value} = f \times a$$

f: Input pulse frequency (number of pulses in 1 second)
a: Prescale value

1. Displaying Rotation Rate

Display unit	Prescale value (a)
rpm	$1/N \times 60$
rps	$1/N$

N: Number of pulses per revolution

Example: In order to display the rate of rotation for a machine that outputs 5 pulses per revolution in the form $\square\square.\square$ rpm:

- Set the decimal point position to 1 decimal place.
- Using the formula, set the prescale value to $1/N \times 60 = 60/5 = 12$.

2. Displaying Speed

Display unit	Prescale value (a)
m/min	$\pi d \times 1/N \times 60$
m/s	$\pi d \times 1/N$

N: Number of pulses per revolution

d: Diameter of rotating body (m)

πd : Circumference (m)

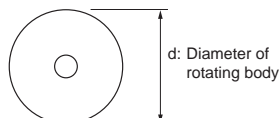

Average Processing (AVG) (Setting possible using DIP switch.)

Flickering display and output chattering can be prevented using average processing (simple averaging). Average processing can be set to one of four levels: no average processing, 2 times (i.e., the average of 2 measurement values), 4 times, or 8 times. The measurement cycle will be equal to the sampling cycle (200 ms) multiplied by the average processing setting (i.e., the number of times). Average processing enables fluctuating input signals to be displayed stably. Set the optimum number of times for the application.

Auto-zero Time ($AVTZ$)

It is possible to set the H7CX so that if there is no pulse for a certain time the display is force-set to 0. This time is called the auto-zero time.

Note: Set the auto-zero time to a time slightly longer than the estimated interval between input pulses and within the setting range (0.1 to 99.9 s). It will not be possible to make accurate measurements if the auto-zero time is set to a time shorter than the input pulse cycle. Setting a time that is too long may also result in problems, such as a time-lag between rotation stopping and the alarm turning ON.

Startup Time ($SETR$)

In order to prevent undesired output resulting from unstable input immediately after the power supply is turned ON, it is possible to prohibit measurement for a set time (0.0 to 99.9 s), the startup time. It can also be used to stop measurement and disable output until the rotating body reaches the normal rate of rotation, after the power supply to the H7CX and rotating body are turned ON at the same time.

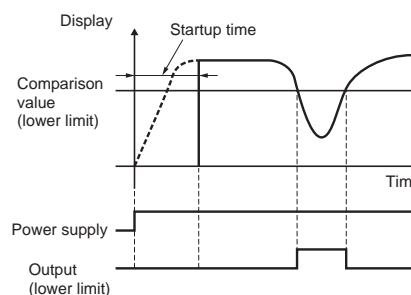

NPN/PNP Input Mode ($\overline{L} \overline{N} \overline{O} \overline{O}$)

Select either NPN input (no-voltage input) or PNP input (voltage input) as the input format. The same setting is used for all external inputs. For details on input connections, refer to *Input Connections* on page 11.

Display Color ($\overline{L} \overline{O} \overline{L} \overline{r}$)

Set the color used for the measurement value.

Setting	Control output OFF	Control output ON
$r \overline{E} d$	Red (fixed)	
$\overline{G} r r n$	Green (fixed)	
$r - \overline{G}$ (See note 1.)	Measured value displayed in red when both control outputs 1 and 2 are OFF.	Measured value displayed in green when either control output 1 or control output 2 is ON.
$\overline{G} - r$ (See note 2.)	Measured value displayed in green when both control outputs 1 and 2 are OFF.	Measured value displayed in red when either control output 1 or control output 2 is ON.

Note: 1. If the tachometer output mode is set to AREA, however, the measured value is displayed in red when control output 1 is OFF and in green when control output 1 is ON.

2. If the tachometer output mode is set to AREA, however, the measured value is displayed in green when control output 1 is OFF and in red when control output 1 is ON.

Output Allocation (出力)

When using H7CX-AU□ models as 2-stage counter, each output can be flexibly allocated to either stage 1 or 2. Transistor output placed for SV1 and contact output for SV2 or vice versa, as in the following table.

H7CX-AU/AUD1

	OUT1	OUT2
\bar{OFF}	Transistor (12-13)	Contact (3, 4, 5)
\bar{ON}	Contact (3, 4, 5)	Transistor (12-13)

H7CX-AUSD1

	OUT1	OUT2
\bar{OFF}	Transistor (12-13)	Transistor with diode (3, 4, 5)
\bar{ON}	Transistor with diode (3, 4, 5)	Transistor (12-13)

Key Protect Level (キープロテクト)

Set the key protect level.

When the key-protect switch is set to ON, it is possible to prevent setting errors by prohibiting the use of certain operation keys by specifying the key protect level (KP-1 to KP-5). The key protect indicator is lit while the key-protect switch is set to ON. Confirm the ON/OFF status of the key-protect switch after the H7CX is mounted to the panel.

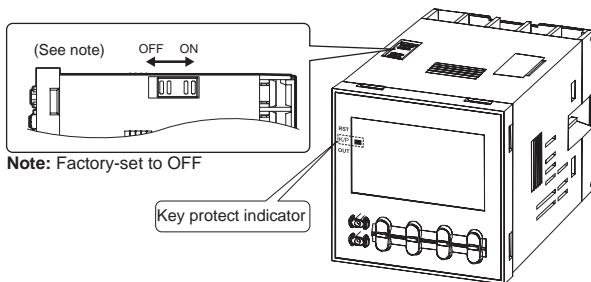

Level	Meaning	Details			
		Changing mode (See note.)	Switching display during operation	Reset key	Up/down key (Up key for 6-digit models)
KP-1 (default setting)		No	Yes	Yes	Yes
KP-2		No	Yes	No	Yes
KP-3		No	Yes	Yes	No
KP-4		No	Yes	No	No
KP-5		No	No	No	No

Note: Changing mode to configuration selection mode (MODE + RS1 1 s min.) or function setting mode (MODE 3 s min.).

Operation in Run Mode

Set values for each digit as required using the  key.

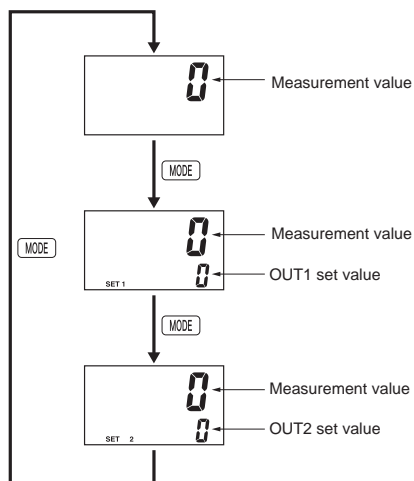
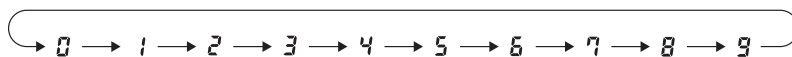

Measurement Value
Displays the currently measured value.

OUT1/OUT2 Set Value
Set OUT1 set value and OUT2 set value. The measurement value is compared to OUT1 set value and OUT2 set value and output is made according to the selected output mode.

Self-diagnostic Function

The following displays will appear if an error occurs.

Main display	Sub-display	Error	Output status	Correction method	Set value after reset
FFFFFF (See note 3.)	No change	Measurement value overflow (See note 2.)	No change	Measurement value ≤ 999999	No change
E1	Not lit	CPU	OFF	Either press the reset key or reset the power supply.	No change
E2	Not lit	Memory error (RAM)	OFF	Reset the power supply.	No change
E2	5U \bar{n}	Memory error (EEP) (See note 1.)	OFF	Reset to the factory settings using the reset key.	0

- Note:**
1. Includes the case where the EEPROM has reached its overwrite lifetime.
 2. Occurs when the measurement value reaches 999,999.
 3. Display flashes (1-second cycles).

Output Mode Settings

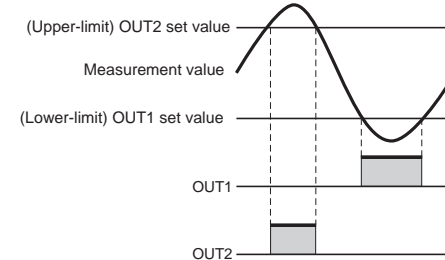
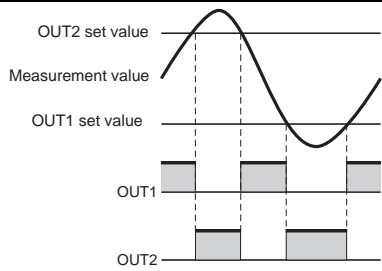
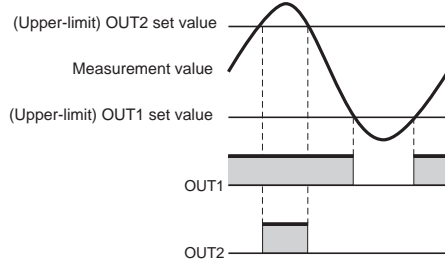
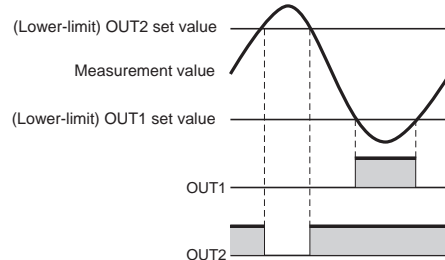
<p>Output mode setting</p>	<p>Upper and lower limit (HI-LO)</p>	 <p>(Upper-limit) OUT2 set value</p> <p>Measurement value</p> <p>(Lower-limit) OUT1 set value</p> <p>OUT1</p> <p>OUT2</p> <p>ON condition for OUT1: measurement value \leq OUT1 set value ON condition for OUT2: measurement value \geq OUT2 set value</p>									
	<p>Area (AREA)</p>	 <table border="1" data-bbox="367 884 1484 1064"> <thead> <tr> <th>Condition</th> <th>OUT1 set value \leq OUT2 set value</th> <th>OUT1 set value $>$ OUT2 set value</th> </tr> </thead> <tbody> <tr> <td>ON condition for OUT1</td> <td>OUT1 set value \leq measurement value \leq OUT2 set value</td> <td>OUT2 set value \leq measurement value \leq OUT1 set value</td> </tr> <tr> <td>ON condition for OUT2</td> <td>measurement value $<$ OUT1 set value or measurement value $>$ OUT2 set value</td> <td>measurement value $<$ OUT2 set value or measurement value $>$ OUT1 set value</td> </tr> </tbody> </table>	Condition	OUT1 set value \leq OUT2 set value	OUT1 set value $>$ OUT2 set value	ON condition for OUT1	OUT1 set value \leq measurement value \leq OUT2 set value	OUT2 set value \leq measurement value \leq OUT1 set value	ON condition for OUT2	measurement value $<$ OUT1 set value or measurement value $>$ OUT2 set value	measurement value $<$ OUT2 set value or measurement value $>$ OUT1 set value
Condition	OUT1 set value \leq OUT2 set value	OUT1 set value $>$ OUT2 set value									
ON condition for OUT1	OUT1 set value \leq measurement value \leq OUT2 set value	OUT2 set value \leq measurement value \leq OUT1 set value									
ON condition for OUT2	measurement value $<$ OUT1 set value or measurement value $>$ OUT2 set value	measurement value $<$ OUT2 set value or measurement value $>$ OUT1 set value									
	<p>Upper limit (HI-HI)</p>	 <p>(Upper-limit) OUT2 set value</p> <p>Measurement value</p> <p>(Upper-limit) OUT1 set value</p> <p>OUT1</p> <p>OUT2</p> <p>ON condition for OUT1: Measurement value \geq OUT1 set value ON condition for OUT2: Measurement value \geq OUT2 set value</p>									
	<p>Lower limit (LO-LO)</p>	 <p>(Lower-limit) OUT2 set value</p> <p>Measurement value</p> <p>(Lower-limit) OUT1 set value</p> <p>OUT1</p> <p>OUT2</p> <p>ON condition for OUT1: Measurement value \leq OUT1 set value ON condition for OUT2: Measurement value \leq OUT2 set value</p>									

■ Operation in Configuration Selection Mode

Select which H7CX configuration is used (i.e., 1-stage counter, 2-stage counter, total and preset counter, batch counter, dual counter, or tachometer) in configuration selection mode. The H7CX is also equipped with a DIP switch monitor function, a convenient function that enables the settings of the DIP switch pins to be confirmed using the front display.

- Counting stopped
- Counting possible

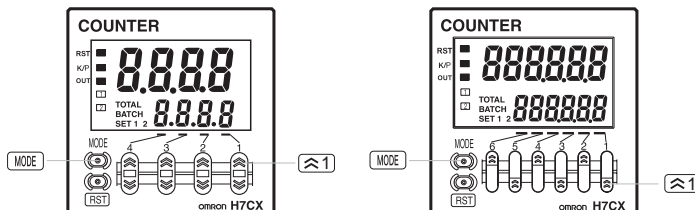
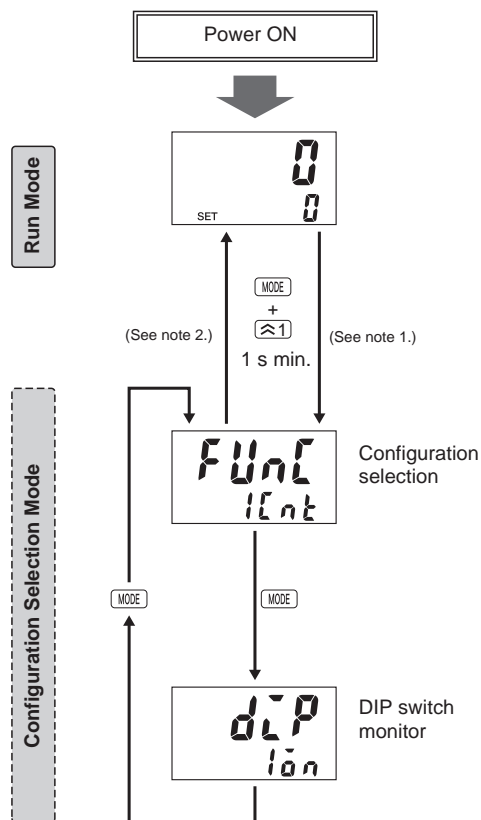

To change the mode to configuration selection mode, press the ≈ 1 Key for 1 s min. with the MODE key held down. The mode will not change if the ≈ 1 key is pressed first.

Select the configuration using the \approx and \approx keys. (\approx key only for 6-digit models)
The H7CX is factory-set to the 1-stage counter configuration (2-stage counter configuration with H7CX-AW□/-A4W□ models).

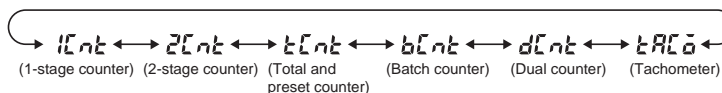

The configuration that can be selected depend on the model.

The status of the DIP switch pins (1 to 8) can be confirmed using the \approx and \approx keys.

Note: This display is possible only if DIP switch pin 1 (DIP switch settings) is set to ON (i.e., enabled).

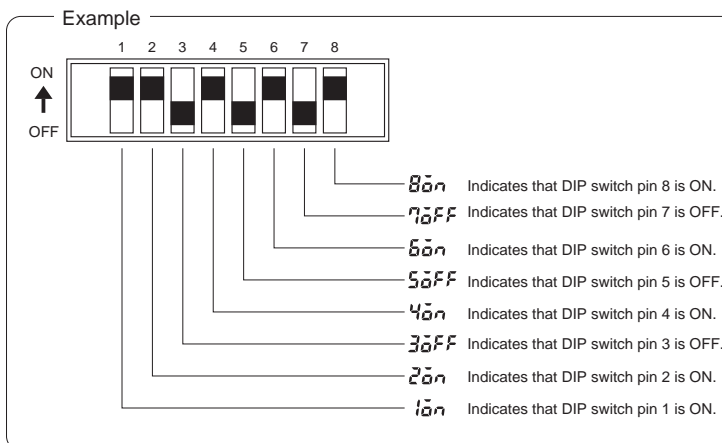

- Note:**
1. When the mode is changed to configuration selection mode, the present value is reset, outputs turns OFF, and counting (measuring) stops.
 2. Setting changes made in configuration selection mode are enabled when the mode is changed to run mode. If the configuration is changed, the set value (or set value 1 and set value 2), OUT1 set value or OUT2 set value are initialized.

Additional Information

Key Operation Flowchart

Counter Operation

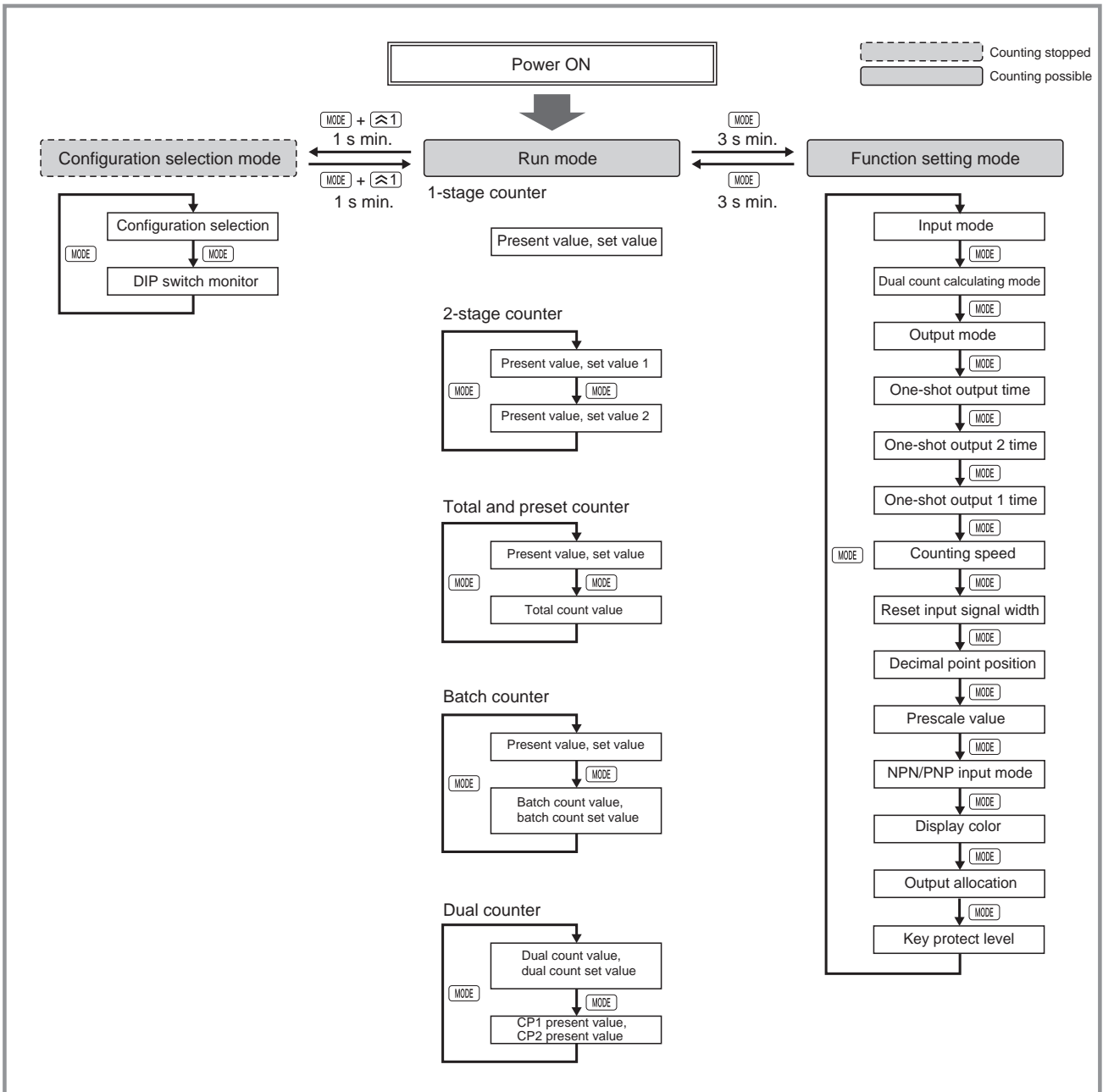

- Note:** 1. Perform settings using the and keys (key only with 6-digit models).
 2. The above flowcharts outline the procedures for all models. For more details on each model, refer to page 19.

Tachometer Operation

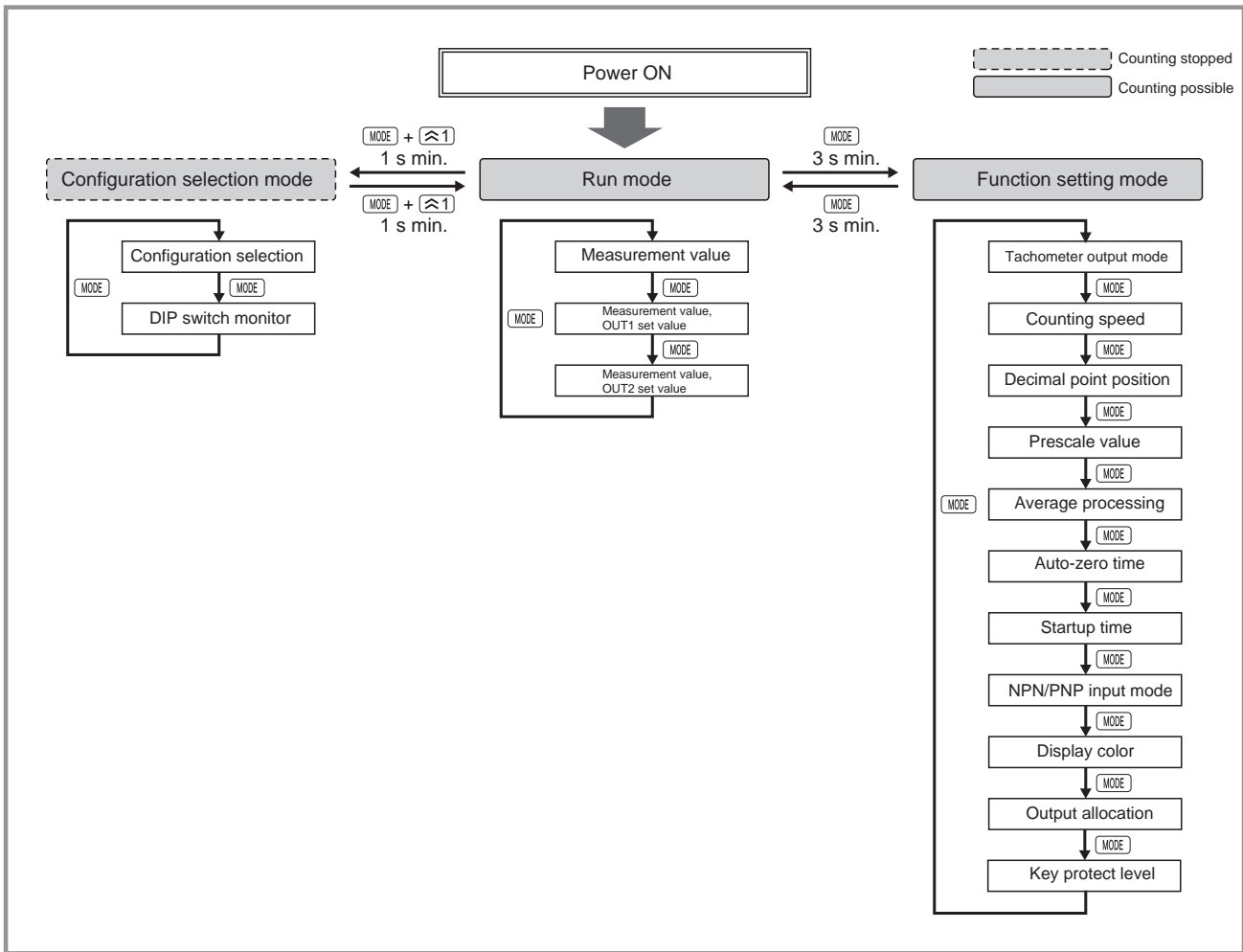

- Note:**
1. All setting changes are performed using the $\hat{\approx}$ key.
 2. For details, refer to page 31.

■ Lists of Settings

Fill in your set values in the set value column of the following tables and utilize the tables for quick reference.

Configuration Selection Mode

Parameter name	Parameter	Setting range	Default value	Unit	Set value
Configuration selection	$FUnE$	$1E_{nt}/2E_{nt}/tE_{nt}/bE_{nt}/dE_{nt}/tAE_{\bar{0}}$ (See note 1.)	$1E_{nt}$ (See note 2.)	---	
DIP switch monitor	dCP	$\bar{0}n/\bar{0}FF$	$\bar{0}FF$	---	---

- Note:** 1. The setting range varies with the model.
 2. The default value for H7CX-AW□/A4W□ models is $2E_{nt}$.

Settings for Counter Operation

Run Mode

• 1-stage Counter

Parameter name	Parameter	Setting range	Default value	Unit	Set value
Present value, set value	Present value	---	-99999 to 999999 (-999 to 9999)	$\bar{0}$	--
	Set value	---	$\bar{0}$ to 999999 ($\bar{0}$ to 9999) (For conditions other than those described in note 1.) -99999 to 999999 (-999 to 9999) (See note 1.)	$\bar{0}$	---

• 2-stage Counter

Parameter name	Parameter	Setting range	Default value	Unit	Set value
Present value, set value 1	Present value	---	-99999 to 999999 (-999 to 9999)	$\bar{0}$	---
	Set value 1	---	$\bar{0}$ to 999999 ($\bar{0}$ to 9999) (For conditions other than those described in note 1.) -99999 to 999999 (-999 to 9999) (See note 1.)	$\bar{0}$	---
Present value, set value 2	Present value	---	-99999 to 999999 (-999 to 9999)	$\bar{0}$	---
	Set value 2	---	$\bar{0}$ to 999999 ($\bar{0}$ to 9999) (For conditions other than those described in note 1.) -99999 to 999999 (-999 to 9999) (See note 1.)	$\bar{0}$	---

• Total and Preset Counter

Parameter name	Parameter	Setting range	Default value	Unit	Set value
Present value, set value	Present value	---	-99999 to 999999 (-999 to 9999)	$\bar{0}$	---
	Set value	---	$\bar{0}$ to 999999 ($\bar{0}$ to 9999) (For conditions other than those described in note 1.) -99999 to 999999 (-999 to 9999) (See note 1.)	$\bar{0}$	---
Total count value	---	-99999 to 999999 (-999 to 9999)	$\bar{0}$	---	---

• Batch Counter

Parameter name	Parameter	Setting range	Default value	Unit	Set value
Present value, set value	Present value	---	-99999 to 999999 (-999 to 9999)	$\bar{0}$	---
	Set value	---	$\bar{0}$ to 999999 ($\bar{0}$ to 9999) (For conditions other than those described in note 1.) -99999 to 999999 (-999 to 9999) (See note 1.)	$\bar{0}$	---
Batch count value, batch count set value	Batch count value	---	$\bar{0}$ to 999999 ($\bar{0}$ to 9999)	$\bar{0}$	---
	Batch count set value	---	$\bar{0}$ to 999999 ($\bar{0}$ to 9999)	$\bar{0}$	---

• Dual Counter

Parameter name		Parameter	Setting range	Default value	Unit	Set value
Dual count value, dual count set value	Dual count value	---	-99999 to 999999 (-999 to 9999)	0	---	---
	Dual count set value	---	0 to 999999 (0 to 9999) (For conditions other than those described in note 2.) -99999 to 999999 (-999 to 9999) (See note 2.)	0	---	---
CP1 present value, CP2 present value	CP1 present value	---	0 to 999999 (0 to 9999)	0	---	---
	CP2 present value	---	0 to 999999 (0 to 9999)	0	---	---

- Note:** 1. The input mode is increment/decrement mode and the output mode is K-2, D, L, or H.
2. The dual count calculating mode is subtraction mode and the output mode is K-2, D, L, or H.

Function Setting Mode

Parameter name	Parameter	Setting range	Default value	Unit	Set value
Input mode	$\bar{C}n\bar{E}\bar{n}$	$\bar{U}P/\bar{d}\bar{d}\bar{U}n/\bar{U}d-\bar{R}/\bar{U}d-\bar{b}/\bar{U}d-\bar{C}$ (See note 1.)	$\bar{U}P$	---	---
Dual count calculating mode	$\bar{C}R\bar{L}n$	$\bar{R}dd/\bar{S}ub$ (See note 1.)	$\bar{R}dd$	---	---
Output mode	$\bar{d}\bar{U}\bar{E}\bar{n}$	$n/\bar{F}/\bar{C}/\bar{r}/\bar{H}-\bar{U}/\bar{P}/\bar{B}/\bar{R}/\bar{H}-\bar{2}/\bar{d}/\bar{L}/\bar{H}$ (See note 2.)	n	---	---
One-shot output time	$\bar{d}\bar{E}\bar{n}\bar{1}$	0.0 1 to 99.99	0.50	s	---
One-shot output 2 time	$\bar{d}\bar{E}\bar{n}\bar{2}$	0.0 1 to 99.99	0.50	s	---
One-shot output 1 time	$\bar{d}\bar{E}\bar{n}\bar{1}$	$\bar{H}\bar{d}\bar{L}\bar{d}/\bar{0}.\bar{0}\bar{1}$ to 99.99 (See note 3.)	$\bar{H}\bar{d}\bar{L}\bar{d}$	s	---
Counting speed	$\bar{C}n\bar{E}\bar{S}$	$\bar{3}\bar{0}\bar{H}\bar{E}/\bar{S}\bar{P}\bar{H}\bar{E}$	$\bar{3}\bar{0}\bar{H}\bar{E}$	---	---
Reset input signal width	$\bar{L}\bar{F}\bar{L}\bar{E}$	$\bar{2}\bar{0}\bar{n}\bar{5}/\bar{i}\bar{n}\bar{5}$	$\bar{2}\bar{0}\bar{n}\bar{5}$	---	---
Decimal point position	$\bar{d}\bar{P}$	-----/-----/-/-----/-/----- (-----/-/-----/-/-----)	----- (-----)	---	---
Prescale value	$\bar{P}\bar{S}\bar{C}\bar{L}$	0.00 1 to 99.999 (0.00 1 to 9.999)	1.000	---	---
NPN/PNP input mode	$\bar{L}\bar{n}\bar{d}$	$n\bar{P}n/\bar{P}n\bar{P}$	$n\bar{P}n$	---	---
Display color	$\bar{C}\bar{d}\bar{L}\bar{r}$	$r\bar{E}d/\bar{G}r\bar{n}/r-\bar{G}/\bar{G}-r$	$r\bar{E}d$	---	---
Output allocation	$\bar{d}\bar{E}\bar{S}\bar{E}$	$\bar{d}\bar{F}\bar{F}/\bar{G}n$	$\bar{d}\bar{F}\bar{F}$	---	---
Key protect level	$\bar{K}\bar{Y}\bar{P}\bar{L}$	$\bar{K}\bar{P}-\bar{1}/\bar{K}\bar{P}-\bar{2}/\bar{K}\bar{P}-\bar{3}/\bar{K}\bar{P}-\bar{4}/\bar{K}\bar{P}-\bar{5}$	$\bar{K}\bar{P}-\bar{1}$	---	---

- Note:** 1. The setting range varies with the output mode.
2. The setting range varies with the model and the input mode.
3. HOLD cannot be set when the output mode is K-2.

Settings for Tachometer Operation

Run Mode

Parameter name		Parameter	Setting range	Default value	Unit	Set value
Measurement value		---	0 to 999999	0	---	---
Measurement value, OUT1 set value	Measurement value	---	0 to 999999	0	---	---
	OUT1 set value	---	0 to 999999	0	---	---
Measurement value, OUT2 set value	Measurement value	---	0 to 999999	0	---	---
	OUT2 set value	---	0 to 999999	0	---	---

Function Setting Mode

Parameter name	Parameter	Setting range	Default value	Unit	Set value
Tachometer output mode	$\overline{t\bar{o}t\bar{n}}$	$H\bar{o}Ld/Rr-ER/MC/MC/L\bar{o}L\bar{o}$	$H\bar{C}L\bar{o}$	---	
Counting speed	$\overline{c\bar{n}t\bar{s}}$	$30Hz/10MHz$	$30Hz$	---	
Decimal point position	\overline{dP}	-----/-----/-----/-----	-----	---	
Prescale value	$\overline{P\bar{s}C\bar{L}}$	0.001 to 99.999	1.000	---	
Average processing	$\overline{R\bar{u}G}$	$\bar{o}FF/2/4/8$	$\bar{o}FF$	---	
Auto-zero time	$\overline{R\bar{u}t\bar{z}}$	0.1 to 99.9	99.9	---	
Startup time	$\overline{St\bar{n}r}$	0.0 to 99.9	0.0	s	
NPN/PNP input mode	$\overline{I\bar{n}o\bar{d}}$	nPn/PnP	nPn	s	
Display color	$\overline{C\bar{o}Lr}$	$rEd/Grr/r-G/G-r$	rEd	---	
Output allocation	$\overline{o\bar{t}S\bar{t}}$	$\bar{o}FF/\bar{o}n$	$\bar{o}FF$	---	
Key protect level	$\overline{K\bar{y}P\bar{L}}$	$MP-1/MP-2/MP-3/MP-4/MP-5$	$MP-1$	---	

Tachometer H7CX-R

DIN 48 × 48 mm Socket-type Tachometer with a Bright, Easy-to-view, Backlit Negative Transmissive LCD

- Socket design allows either flush or surface mounting.
- Operation in any of the four following modes is possible with the same Unit: Upper and lower limit, upper limit, lower limit, and area.
- Equipped with auto-zero time, average processing, and startup time functions.



Contents

Model Number Structure	43
Ordering Information	43
Specifications	44
Connections	46
Nomenclature	48
Dimensions.....	49
Operating Procedures	50
Additional Information.....	57

Model Number Structure

Model Number Legend

Note: Some configurations are not available.

H7CX-R11□
1 2

1. Terminal structure

11: 11-pin socket

2. Supply voltage

None: 100 to 240 VAC, 50/60 Hz

D1: 24 VDC, 50/60 Hz, 12 to 24 VDC

Ordering Information

List of Models

Sensor power supply	Output type	Supply voltage	Tachometer
			11-pin socket
12 VDC	Contact output	100 to 240 VAC	H7CX-R11
		24 VAC/12 to 24 VDC	H7CX-R11D1

Accessories (Order Separately)

Name		Models
Flush Mounting Adapter		Y92F-30
Waterproof Packing		Y92S-29
Track Mounting/Front Connecting Socket	11-pin	P2CF-11
	11-pin, finger-safe type	P2CF-11-E
Back Connecting Socket	11-pin	P3GA-11
	11-pin, finger-safe type	P3GA-11 with Y92A-48G (See note.)
Hard Cover		Y92A-48
Soft Cover		Y92A-48F1
Mounting Track	50 cm (l) × 7.3 mm (t)	PFP-50N
	1 m (l) × 7.3 mm (t)	PFP-100N
	1 m (l) × 16 mm (t)	PFP-100N2
End Plate		PFP-M
Spacer		PFP-S

Note: Y92A-48G is a finger-safe terminal cover attached to the P3GA-11 Socket.

Specifications

■ Ratings

Classification	Tachometer
Rated supply voltage (See note 1.)	100 to 240 VAC (50/60 Hz) 24 VAC (50/60 Hz)/12 to 24 VDC
Operating voltage range	85% to 110% of rated supply voltage (90% to 110% at 12 VDC)
Power consumption	Approx. 9.4 VA at 264 VAC Approx. 7.1 VA at 26.4 VAC Approx. 4.7 W at 12 VDC
Mounting method	Flush mounting, surface mounting, or DIN track mounting
External connections	11-pin socket
Display (See note 2.)	7-segment, negative transmissive LCD; Present value: 9-mm-high characters, red Comparison value: 6-mm-high characters, green
Digits	6 digits(0 to 999999)
Input signals	Count, hold
Input method	No-voltage input/voltage input (switchable) No-voltage input ON impedance: 1 kΩ max. (Leakage current: 5 to 20 mA at 0 Ω) ON residual voltage: 3 V max. OFF impedance: 100 kΩ min. Voltage input High (logic) level: 4.5 to 30 VDC Low (logic) level: 0 to 2 VDC (Input resistance: approx. 4.7 kΩ)
Hold input	Minimum input signal width: 20 ms
Pulse measurement method	Periodic measurement (Sampling period: 200 ms)
Max. counting speed	30 Hz or 10 kHz (selectable)
Measuring range	30 Hz: 0.001 Hz to 30.00 Hz 10 kHz: 0.001 Hz to 10 kHz
Measuring accuracy	±0.1% FS ±1 digit max. (at 23 ±5°C)
Output modes	HI-LO, AREA, HI, LO
Auto-zero time	0.1 to 999.9 s
Startup time	0.0 to 99.9 s
Average processing	OFF/2/4/8 times
Control output	Contact output: 3 A at 250 VAC/30 VDC, resistive load (cosφ=1) Minimum applied load: 10 mA at 5 VDC (failure level: P, reference value) NEMA B300 Pilot Duty, 1/4 HP 3-A resistive load at 120 VAC, 1/3 HP 3-A resistive load at 240 VAC
Output type	SPDT
External power supply	12 VDC (±10%), 100 mA Refer to <i>Safety Precautions</i> (page 60) for details.
Key protection	Yes
Prescaling function	0.001 to 99.999
Decimal point adjustment	Rightmost 3 digits
Sensor waiting time	250 ms max. (Control output is turned OFF and no input is accepted during sensor waiting time.)
Memory backup	EEPROM (overwrites: 100,000 times min.) that can store data for 10 years min.
Ambient temperature	Operating: -10 to 55°C (-10 to 50°C if tachometers are mounted side by side) (with no icing or condensation) Storage: -25 to 65°C (with no icing or condensation)
Ambient humidity	25% to 85%
Case color	Black (N1.5)

- Note:** 1. Permissible ripple: 20% (p-p) max.
2. The display is lit only when the power is ON.

Characteristics

Item	H7CX-R
Insulation resistance	100 MΩ min. (at 500 VDC) between current-carrying terminal and exposed non-current-carrying metal parts, and between non-continuous contacts
Dielectric strength	2,000 VAC, 50/60 Hz for 1 min between current-carrying metal parts and non-current-carrying metal parts 2,000 VAC (for 100 to 240 VAC), 50/60 Hz for 1 min between power supply and input circuit (1,000 VAC for 24 VAC/12 to 24 VDC) 2,000 VAC 50/60 Hz for 1 min between control output, power supply, and input circuit 1,000 VAC, 50/60 Hz for 1 min between non-continuous contacts
Impulse withstand voltage	3 kV (between power terminals) for 100 to 240 VAC, 1 kV for 24 VAC/12 to 24 VDC 4.5 kV (between current-carrying terminal and exposed non-current-carrying metal parts) for 100 to 240 VAC, 1.5 kV for 24 VAC/12 to 24 VDC
Noise immunity	±1.5 kV (between power terminals) ±600 V (between input terminals) Square-wave noise by noise simulator (pulse width: 100 ns/1 μs, 1-ns rise)
Static immunity	Destruction: 15 kV Malfunction: 8 kV
Vibration resistance	Destruction: 10 to 55 Hz with 0.75-mm single amplitude, each in three directions four cycles (8 min per cycle) Malfunction: 10 to 55 Hz with 0.35-mm single amplitude, each in three directions four cycles (8 min per cycle)
Shock resistance	Destruction: 294 m/s ² each in three directions Malfunction: 98 m/s ² each in three directions
Life expectancy	Mechanical: 10,000,000 operations min. Electrical: 100,000 operations min. (3 A at 250 VAC, resistive load) See <i>Life-test Curve (Reference Values)</i> on page 45.
Approved safety standards (See notes 1 and 2.)	UL508/Listing, UL 50 Type 4X for indoor use (enclosure rating) CSA C22.2 No. 14, conforms to EN61010-1 (Pollution degree 2/overvoltage category II)
EMC	(EMI) EN61326 Emission Enclosure: EN55011 Group 1 class A Emission AC mains: EN55011 Group 1 class A (EMS) EN61326 Immunity ESD: EN61000-4-2: 4 kV contact discharge (level 2); 8 kV air discharge (level 3) Immunity RF-interference: EN61000-4-3: 10 V/m (Amplitude-modulated, 80 MHz to 1 GHz) (level 3); 10 V/m (Pulse-modulated, 900 MHz ±5 MHz) (level 3) Immunity Conducted Disturbance: EN61000-4-6: 10 V (0.15 to 80 MHz) (level 3) Immunity Burst: EN61000-4-4: 2 kV power-line (level 3); 1 kV I/O signal-line (level 4) Immunity Surge: EN61000-4-5: 1 kV line to lines (power and output lines) (level 2); 2 kV line to ground (power and output lines) (level 3) Immunity Voltage Dip/Interruption: EN61000-4-11: 0.5 cycle, 100% (rated voltage)
Degree of protection	Panel surface: IP66, NEMA 4 (indoors), and UL Type 4X (indoors) (See note 2.)
Weight	Approx. 140 g

Note: 1. To meet UL listing requirements with the H7CX-R11□ models, an OMRON P2CF-11-□ or P3GA-11 Socket must be mounted on the H7CX. Otherwise, H7CX-R11□ models are considered to meet UL508 recognition requirements.
2. The Y92S-29 Waterproof Packing and Y92F-30 Flush Mounting Adapter are necessary to ensure IP66, NEMA4, and UL Type 4X waterproofing between the H7CX and installation panel.

Life-test Curve (Reference Values)

Resistive Load

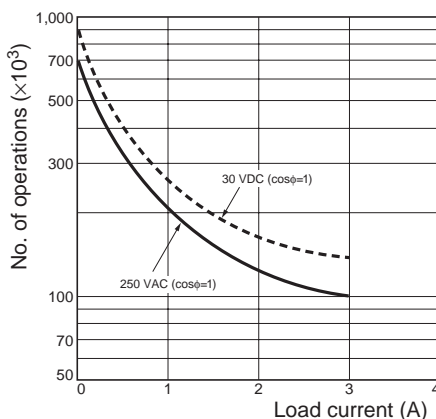

Inductive Load

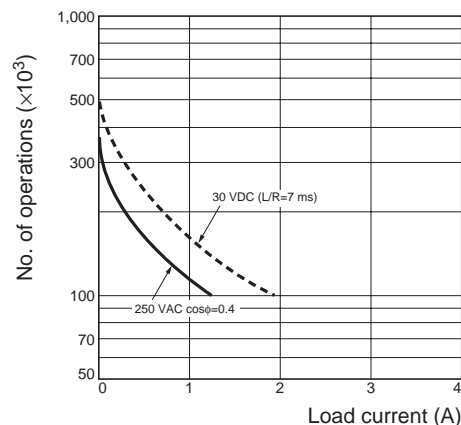

Reference: A current of 0.15 A max. can be switched at 125 VDC (cosφ=1) and current of 0.1 A max. can be switched if L/R=7 ms. In both cases, a life of 100,000 operations can be expected. The minimum applicable load is 10 mA at 5 VDC (failure level: P).

Inrush Current (Reference Values)

Model	Voltage	Applied voltage	Inrush current (peak value)	Time
H7CX-R11	100 to 240 VAC	264 VAC	5.8 A	0.7 ms
H7CX-R11D1	24 VAC/12 to 24 VDC	26.4 VAC	10.4 A	1.2 ms

Connections

■ Block Diagram

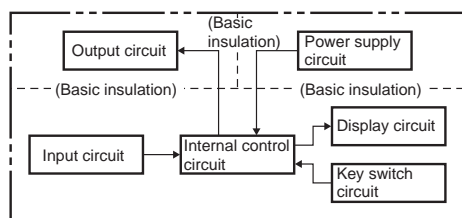

■ I/O Functions

Inputs	Count	Reads counting signals.
	Hold	Holds the measurement value and outputs. The hold indicator is lit during hold.
Outputs	OUT	Outputs signals according to the specified output mode when a comparison value is reached.

Note: Refer to page 55 for details on the hold function.

■ Terminal Arrangement

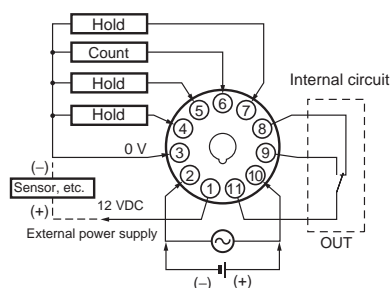

Note: 1. Terminals 4, 5, and 7 are all for the hold function. The function is the same whichever terminal is connected. Terminals 4, 5, and 7 are not connected internally and so do not use them for bridge wiring.

2. Recommended wire: AWG 18 to 24 (Cross-sectional area: 0.205 to 0.823 mm²), solid or twisted, copper or aluminum

■ Input Circuits

Count and Hold Inputs

No-voltage Inputs (NPN Inputs)

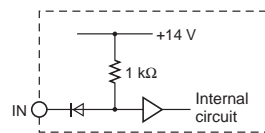

Voltage Inputs (PNP Inputs)

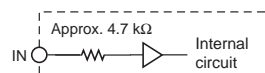

Input Connections

The inputs of the H7CX-R can be used as either no-voltage (short-circuit or open) inputs or voltage inputs. They are set for use as voltage inputs at the time of delivery.

No-voltage Inputs (NPN Inputs)

Open Collector

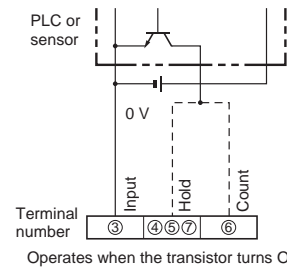

Voltage Output

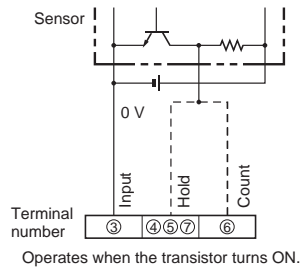

Contact Input

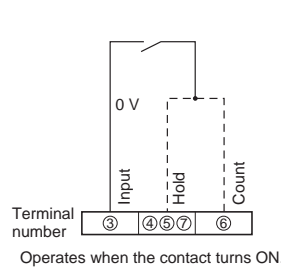

DC Two-wire Sensor

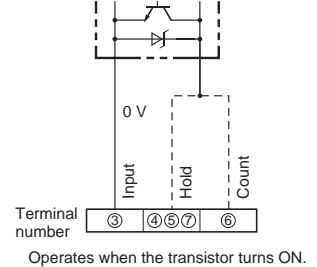

No-voltage Input Signal Levels

No-contact input	Short-circuit level (Transistor ON) Residual voltage: 3 V max. Impedance when ON: 1 k Ω max. (The leakage current is 5 to 20 mA when the impedance is 0 Ω)
	Open level (Transistor OFF) Impedance when OFF: 100 k Ω min.
Contact input	Use contact which can adequately switch 5 mA at 10 V.

Note: The DC voltage must be 30 VDC max.

Applicable Two-wire Sensor

Leakage current: 1.5 mA max.
Switching capacity: 5 mA min.
Residual voltage: 3.0 VDC max.
Operating voltage: 10 VDC

Voltage Inputs (PNP Inputs)

No-contact Input (NPN Transistor)

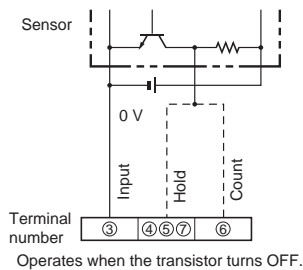

No-contact Input (PNP Transistor)

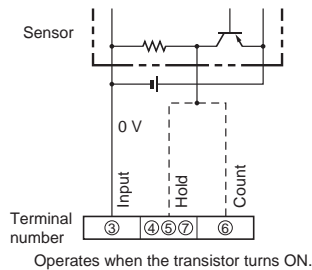

Contact Input

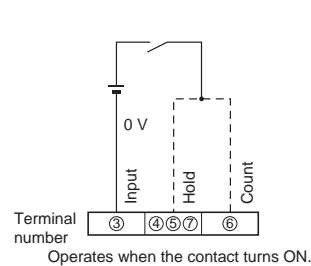

Voltage Input Signal Levels

High level (Input ON): 4.5 to 30 VDC
Low level (Input OFF): 0 to 2 VDC
Input resistance: Approx. 4.7 k Ω

Note: The DC voltage must be 30 VDC max.

Nomenclature

Indicators

- ① Hold Indicator (Orange)
Lit when the hold input or hold key is ON.

- ② Key Protection Indicator (Orange)
Lit when the key protect switch is ON.

- ③ Control Output Indicator (Orange)
Lit when output is ON.

- ④ Comparison Value 1, 2 Stage Indicator

- ⑤ Present Value (Main Display)
Character height: 9 mm (Red)

- ⑥ Comparison Value (Sub-display)
Character height: 6 mm (Green)

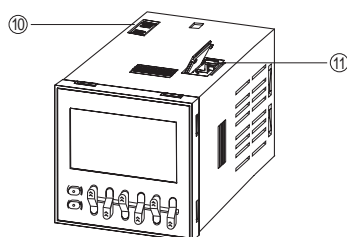
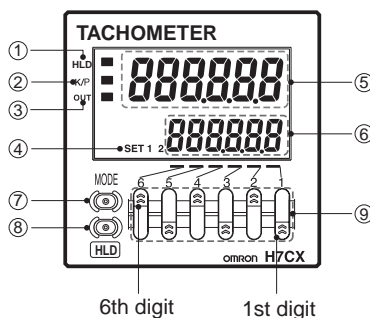

Operation Keys

- ⑦ Mode Key
Used to switch mode and setting items.

- ⑧ Hold Key
Used to sustain the measurement value and output.

- ⑨ Up Keys: 1 to 6

Switches

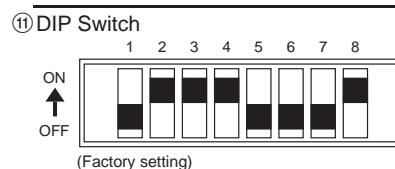
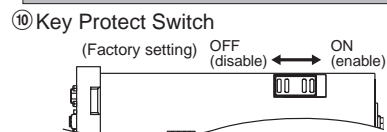

Dimensions

Note: All units are in millimeters unless otherwise indicated.

Tachometer (without Flush Mounting Adapter)

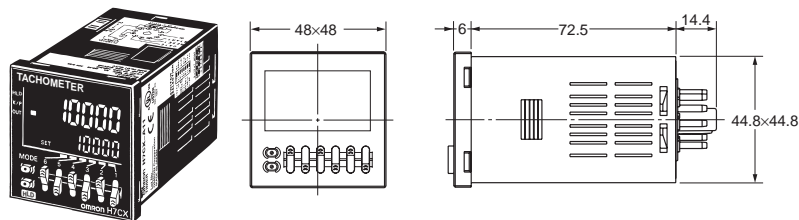

Panel Cutouts

Panel cutouts are as shown below.
(according to DIN43700).

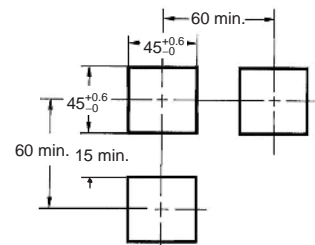

Dimensions with Flush Mounting Adapter

(Adapter and Waterproof Packing Ordered Separately)

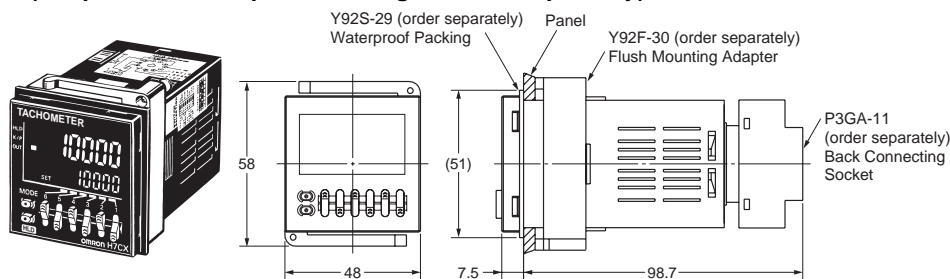

- Note:**
1. The mounting panel thickness should be 1 to 5 mm.
 2. To allow easier operability, it is recommended that Adapters are mounted so that the gap between sides with hooks is at least 15 mm (i.e., so that the panel cutout interval is at least 60 mm).
 3. It is possible to mount counters side by side, but only in the direction without the hooks. If they are mounted side-by-side, water-resistant specifications cannot be ensured.

Dimensions with Front Connecting Socket

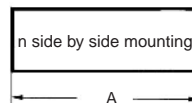
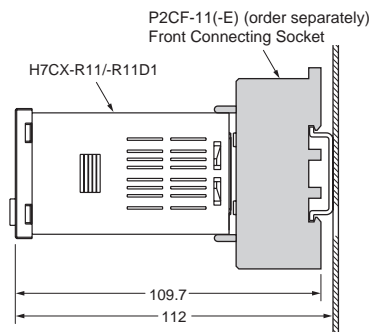

$$A = (48n - 2.5)^{+1}_0$$

With Y92A-48F1 attached,
 $A = (48n - 2.5 + (n-1) \times 4)^{+1}_0$

With Y92A-48 attached,
 $A = (51n - 5.5)^{+1}_0$

Note: These dimensions vary with the kind of DIN track (reference value).

Accessories (Order Separately)

Note: Refer to page 15 for details.

Operating Procedures

■ Settings for Basic Operations

Settings for basic functions are performed with the DIP switch.

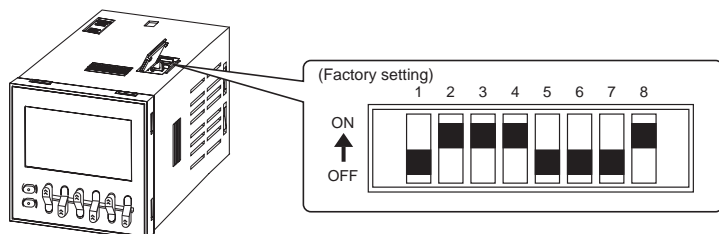

	Item	OFF	ON
1	Not used		
2	Counting speed	30 Hz	10 kHz
3	Output mode	Refer to the table on the right.	
4			
5	Average processing	Refer to the table on the right.	
6			
7	Not used		
8	NPN/PNP input mode	NPN	PNP

Pin 3	Pin 4	Output mode
OFF	OFF	Upper and lower limit
ON	OFF	Area
OFF	ON	Upper limit
ON	ON	Lower limit

Pin 5	Pin 6	Average processing
OFF	OFF	OFF (no average processing)
ON	OFF	2 times
OFF	ON	4 times
ON	ON	8 times

Easy Confirmation of Switch Settings Using Indicators

The ON/OFF status of the DIP switch pins can be confirmed using the front display. For details, refer to page 56.

- Note:**
1. The characters displayed in reverse video are the default settings.
 2. Changes in DIP switch settings are enabled when the power is turned ON.

Settings for Advanced Functions

Settings that cannot be performed with the DIP switch are performed with the operation keys.

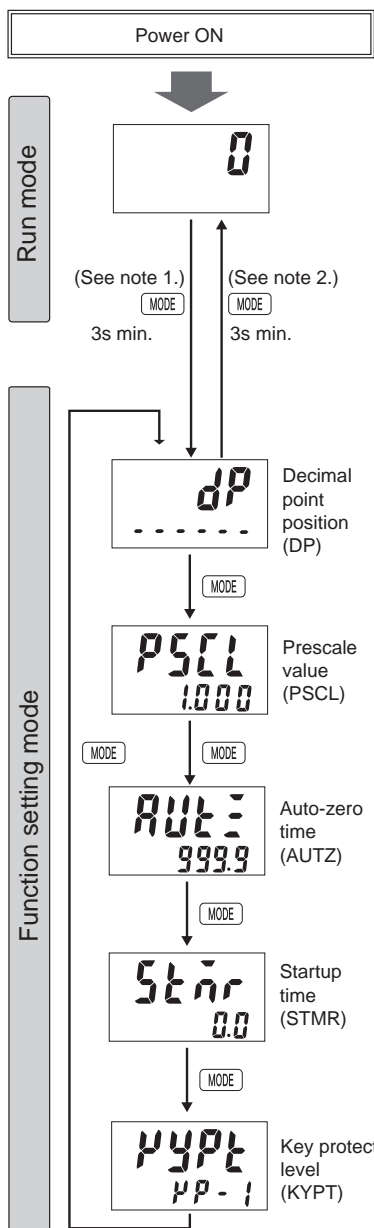

- Note:**
1. If the mode is switched to the function setting mode during operation, operation will continue.
 2. Changes made to settings in function setting mode are enabled for the first time when the mode is changed to run mode. Also, when settings are changed, the counter is re-set (measured values initialized and output turned OFF) on returning to run mode.

For details on operations in run mode, refer to page 54.

The characters displayed in reverse video are the initial values.

Set the decimal point position using the \leftarrow key.

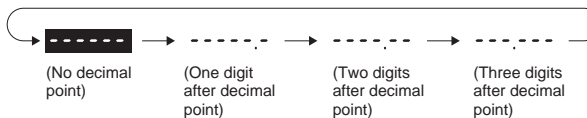

Set the value of each corresponding digit with the \leftarrow key.



Set the value of each corresponding digit with the \leftarrow key.

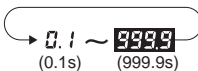

Set the value of each corresponding digit with the \leftarrow key.

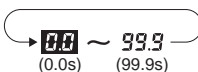

Set the key protect level with the \leftarrow key.

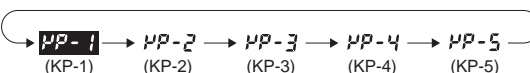

■ Explanation of Functions

Basic Functions

(setting is performed with DIP switch)

Counting Speed

Set the maximum counting speed (30 Hz/10 kHz) for input. If contacts are used for input signals, set the counting speed to 30 Hz. Processing to eliminate chattering is performed for this setting.

Output Mode

Set the output method for control output based on the comparison value. Upper and lower limit (HI-LO), area (AREA), upper limit (HI), and lower limit (LO) can be set. (For details on the operation of the output modes, refer to *Output Mode Settings* on page 55.)

Average Processing

Flickering display and output chattering can be prevented using average processing (simple averaging). Average processing can be set to one of four levels: no average processing, 2 times (i.e., the average of 2 measurement values), 4 times, or 8 times. The measurement cycle will be equal to the sampling cycle (200 ms) multiplied by the average processing setting (i.e., the number of times). Average processing enables fluctuating input signals to be displayed stably. Set the optimum number of times for the application.

NPN/PNP Input Mode

Select either NPN input (no-voltage input) or PNP input (voltage input) as the input format. When using a two-wire sensor, select NPN input. The same setting is used for all external inputs. For details on input connections, refer to *Input Connections* on page 47.

Advanced Functions

(setting is performed with operation keys)

Decimal Point Position (dP)

Decide the decimal point position for the measurement value and comparison value.

Prescale Value ($P5CL$)

It is possible to display the rate of rotation or the speed of a device or machine to which the H7CX-R is mounted by converting input pulses to a desired unit. If this prescaling function is not used, the input frequency (Hz) will be displayed.

The relationship between display and input is determined by the following equation. Set the prescale value according to the unit to be displayed.

$$\text{Displayed value} = f \times a$$

f: Input pulse frequency (number of pulses in 1 second)
a: Prescale value

1. Displaying Rotation Rate

Display unit	Prescale value (a)
rpm	$1/N \times 60$
rps	$1/N$

N: Number of pulses per revolution

Example: In order to display the rate of rotation for a machine that outputs 5 pulses per revolution in the form □□.□ rpm:

1. Set the decimal point position to 1 decimal place.
2. Using the formula, set the prescale value to $1/N \times 60 = 60/5 = 12$.

2. Displaying Speed

Display unit	Prescale value (a)
m/min	$\pi d \times 1/N \times 60$
m/s	$\pi d \times 1/N$

N: Number of pulses per revolution

d: Diameter of rotating body (m)

πd : Circumference (m)

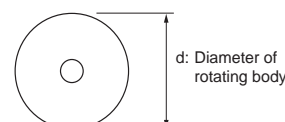

Note: If the prescale value setting is incorrect, a counting error will occur. Check that the settings are correct before using this function.

Auto-zero Time ($Auto-Z$)

It is possible to set the H7CX-R so that if there is no pulse for a certain time the display is force-set to 0. This time is called the auto-zero time.

Note: Set the auto-zero time to a time slightly longer than the estimated interval between input pulses and within the setting range (0.1 to 999.9 s). It will not be possible to make accurate measurements if the auto-zero time is set to a time shorter than the input pulse cycle. Setting a time that is too long may also result in problems, such as a time-lag between rotation stopping and the alarm turning ON.

Startup Time ($Start$)

In order to prevent undesired output resulting from unstable input immediately after the power supply is turned ON, it is possible to prohibit measurement for a set time (0.0 to 99.9 s), the startup time. It can also be used to stop measurement and disable output until the rotating body reaches the normal rate of rotation, after the power supply to the H7CX-R and rotating body are turned ON at the same time.

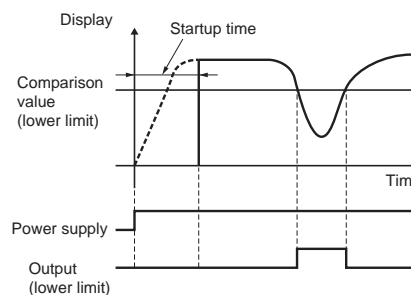

Key Protect Level (KYP_L)

Set the key protect level.

When the key-protect switch is set to ON, it is possible to prevent setting errors by prohibiting the use of certain operation keys by specifying the key protect level (KP-1 to KP-5). The key protect level is set in the function setting mode. The key protect indicator is lit while the key-protect switch is set to ON. Confirm the ON/OFF status of the key-protect switch after the H7CX is mounted to the panel.

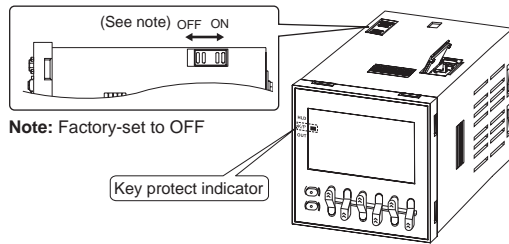

Level	Meaning	Details			
		Changing mode (See note.)	Switching display during operation	Hold key	Up key
KP-1 (default setting)		No	Yes	Yes	Yes
KP-2		No	Yes	No	Yes
KP-3		No	Yes	Yes	No
KP-4		No	Yes	No	No
KP-5		No	No	No	No

Note: Changing mode to DIP switch monitor mode or function setting mode.

■ Operation in Run Mode

Set the values for each digit as required using the  key.



Output Mode: HI or LO

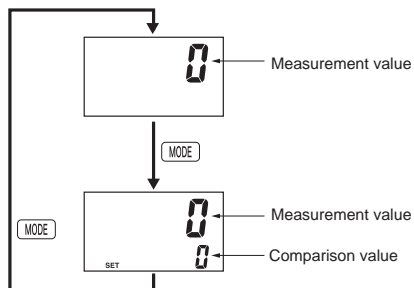

Measurement Value
Displays the currently measured value.

Comparison Value
Set comparison value. The measurement value is compared to comparison value and output is made according to the selected output mode.

Output Mode: HI-LO or AREA

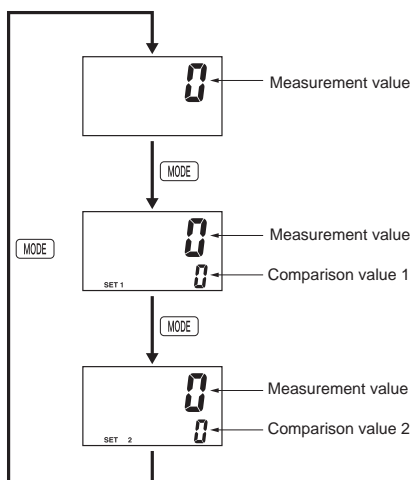

Measurement Value
Displays the currently measured value.

Comparison Value 1/Comparison Value 2
Set comparison value 1 and comparison value 2. The measurement value is compared to comparison value 1 and comparison value 2 and output is made according to the selected output mode.

Output Mode Settings

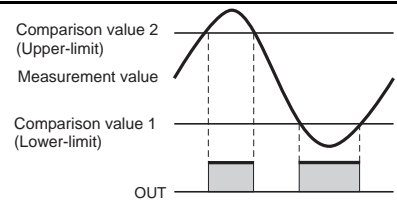
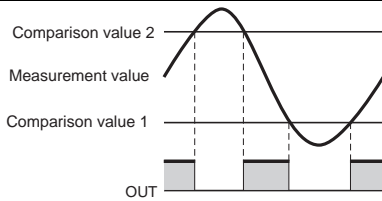
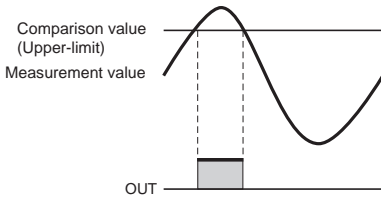
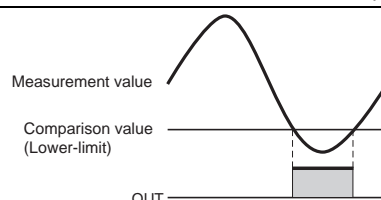
<p>Output mode setting</p>	<p>Upper and lower limit (HI-LO)</p>	 <p>Comparison value 2 (Upper-limit) Measurement value Comparison value 1 (Lower-limit) OUT</p> <p>ON condition: measurement value \leq comparison value 1 or measurement value \geq comparison value 2 Note: When comparison value 1 \geq comparison value 2, the output is always ON regardless of the comparison value.</p>						
	<p>Area (AREA)</p>	 <table border="1" data-bbox="367 784 1484 873"> <thead> <tr> <th>Condition</th> <th>Comparison value 1 \leq Comparison value 2</th> <th>Comparison value 1 $>$ Comparison value 2</th> </tr> </thead> <tbody> <tr> <td>ON condition</td> <td>Comparison value 1 \leq measurement value \leq Comparison value 2</td> <td>Comparison value 2 \leq measurement value \leq Comparison value 1</td> </tr> </tbody> </table>	Condition	Comparison value 1 \leq Comparison value 2	Comparison value 1 $>$ Comparison value 2	ON condition	Comparison value 1 \leq measurement value \leq Comparison value 2	Comparison value 2 \leq measurement value \leq Comparison value 1
Condition	Comparison value 1 \leq Comparison value 2	Comparison value 1 $>$ Comparison value 2						
ON condition	Comparison value 1 \leq measurement value \leq Comparison value 2	Comparison value 2 \leq measurement value \leq Comparison value 1						
	<p>Upper limit (HI)</p>	 <p>Comparison value (Upper-limit) Measurement value OUT</p> <p>ON condition: Measurement value \geq Comparison value</p>						
	<p>Lower limit (LO)</p>	 <p>Measurement value Comparison value (Lower-limit) OUT</p> <p>ON condition: Measurement value \leq Comparison value</p>						

Hold Function

The measurement value (display value) and output are sustained while the hold input is ON.

Example

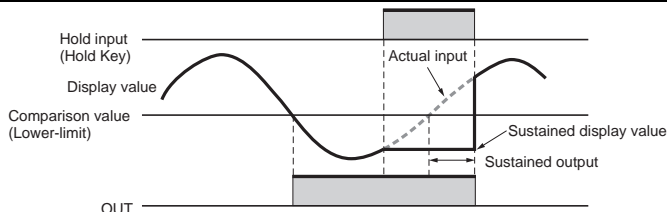
Output mode setting	Operation
<p>Lower limit (LO)</p>	 <p>Hold input (Hold Key) Display value Comparison value (Lower-limit) Actual input Sustained display value Sustained output OUT</p>

Self-diagnostic Function

The following displays will appear if an error occurs.

Main display	Sub-display	Error	Output status	Correction method	Set value after reset
FFFFFF (See note 3.)	No change	Measurement value overflow (See note 2.)	No change	Measurement value ≤ 999999	No change
E1	Not lit	CPU	OFF	Either press the hold key or reset the power supply.	No change
E2	Not lit	Memory error (RAM)	OFF	Reset the power supply.	No change
E2	5U7	Memory error (EEP) (See note 1.)	OFF	Reset to the factory settings using the hold key.	0

- Note:**
1. Includes the case where the EEPROM has reached its overwrite lifetime.
 2. Occurs when the measurement value reaches 999,999.
 3. Display flashes (1-second cycles).

Operation in DIP Switch Monitor Mode

The H7CX-R is also equipped with a DIP switch monitor function, a convenient function that enables the settings of the DIP switch pins to be confirmed using the front display.

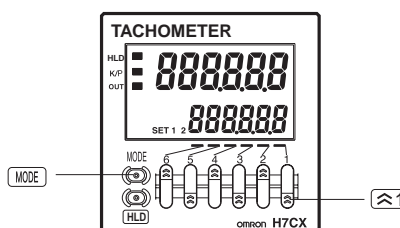
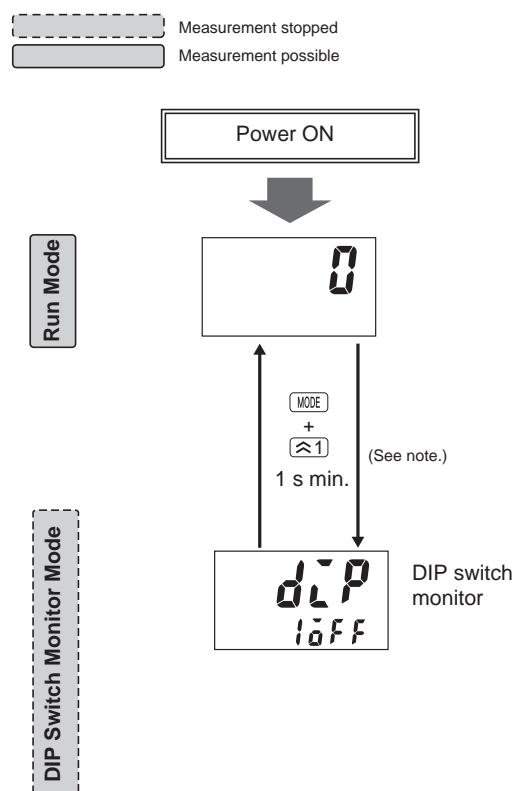

To change the mode to DIP switch monitor mode, press the **MODE** Key for 1 s min. with the **F1** key held down. The mode will not change if the **F1** key is pressed first.

The status of the DIP switch pins (1 to 8) can be confirmed using the **F1** keys.

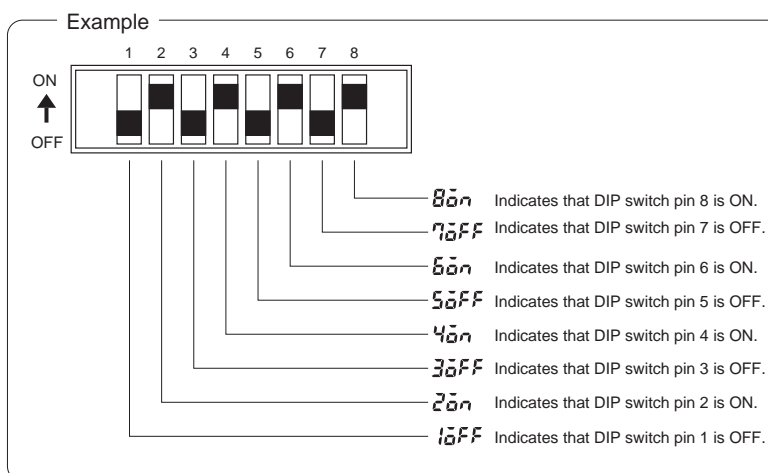

Note: When the mode is changed to DIP switch monitor, the measurement value is reset, outputs turns OFF, and measuring stops.

Additional Information

Key Operation Flowchart

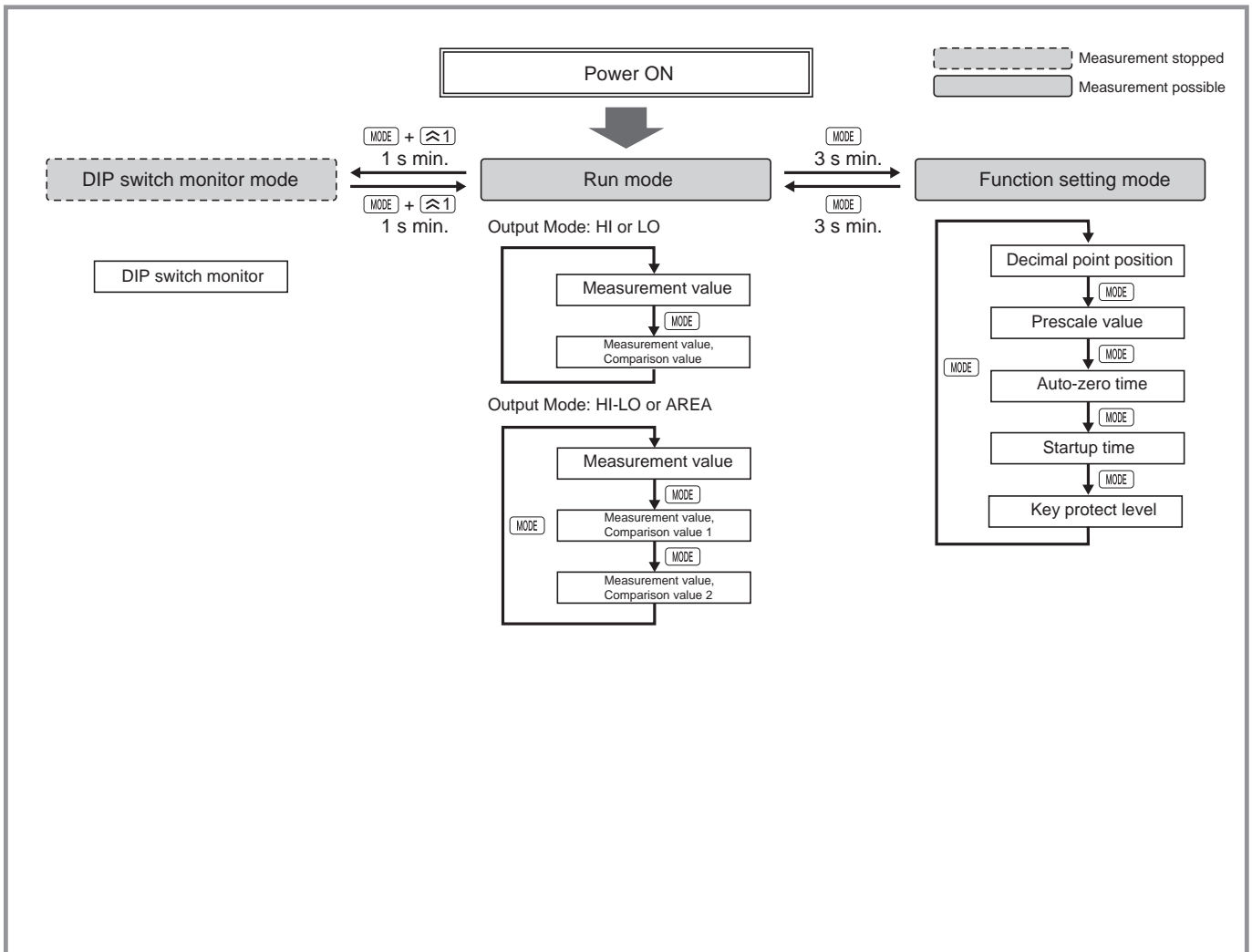

Note: All setting changes are performed using the [MODE] key.

■ Lists of Settings

Run Mode

Parameter name	Parameter	Setting range	Default value	Unit	Set value
Measurement value	---	0 to 999999	0	---	---
Measurement value, Comparison value	Measurement value	0 to 999999	0	---	---
	Comparison value	0 to 999999	0	---	---
Measurement value, Comparison value 1	Measurement value	0 to 999999	0	---	---
	Comparison value 1	0 to 999999	0	---	---
Measurement value, Comparison value 2	Measurement value	0 to 999999	0	---	---
	Comparison value 2	0 to 999999	0	---	---

Function Setting Mode

Parameter name	Parameter	Setting range	Default value	Unit	Set value
Decimal point position	dP	-----/------/------/------	-----	---	---
Prescale value	PSCL	0.001 to 99.999	1.000	---	---
Auto-zero time	RUEE	0.1 to 999.9	999.9	s	---
Startup time	SEnr	0.0 to 99.9	0.0	s	---
Key protect level	KYPL	1P- 1 1P-2 1P-3 1P-4 1P-5	1P- 1	---	---

Safety Precautions (Common)

Note: The following precautions are common for all H7CX models.

⚠ CAUTION

Loose screws may occasionally result in fire or malfunction. Tighten the terminal screws securely. The recommended tightening torque is 0.5 N·m.

There may occasionally be a risk of explosion. Do not use the product where flammable or combustion gases are present.

If the output relay is used beyond its life expectancy, its contacts may occasionally become fused or there may occasionally be a risk of fire. The life expectancy of the output relay varies considerably according to its usage.

Use the output relay within its rated load and electrical life expectancy.

This may occasionally cause electric shock, fire or malfunction. Never disassemble, repair or modify the product.

This may occasionally cause electric shock, fire or malfunction. Do not allow metal fragments or lead wire scraps to fall inside this product.

■ Precautions for Safe Use

Operating and Storage Conditions

- Do not use in locations affected by excessive vibration or shock, or in locations subject to exposure to water or oil.
- Do not use the product in locations subject to dust, corrosive gases, or direct sunlight.
- Separate the input signal devices, input signal cables, and the product from the source of noise or high-tension cables producing noise.
- Separate the product from the source of static electricity when using the product in an environment where a large amount of static electricity is produced (e.g., forming compounds, powders, or fluid materials being transported by pipe).
- Organic solvents (such as paint thinner), as well as very acidic or basic solutions might damage the outer casing of the H7CX.
- Use the product within the ratings specified for temperature and humidity.
- Do not use the product in locations where condensation may occur due to high humidity or where temperature changes are severe.
- Store at the specified temperature. If the H7CX has been stored at a temperature of less than -10°C , allow the H7CX to stand at room temperature for at least 3 hours before use.

Usage Precautions

- Make sure that the voltage applied is within the specified range, otherwise the internal elements of the counter may be damaged.
- The load current must be within the rated current.
- Ensure that the power is turned OFF before changing DIP switch settings. Changing DIP switch settings with the power turned ON may result in electric shock due to contact with terminals subject to high voltages.
- Pay attention to terminal polarity to ensure correct wiring.
- Make sure that the fluctuation of the supply voltage is within the permissible range.
- Apply the power supply voltage through a relay or switch in such a way that the voltage reaches the rated value within 2 s. If the voltage is applied gradually, the power may not be reset or unstable output operations may result.
- Set each set value to match the item being counted (or measured). Not matching the content of the set values with the counted (or measured) items may cause unexpected operations resulting in injury or damage to the equipment.

- Leaving the H7CX with outputs ON at a high temperature for a long time may hasten the degradation of internal parts (such as electrolytic capacitors). Therefore, use the product in combination with relays and avoid leaving the product as long as more than 1 month with the output turned ON.

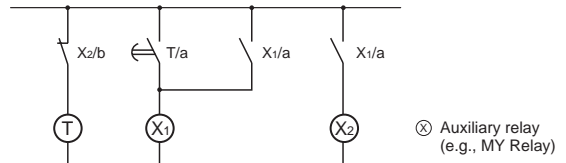

- When the product is operated with no-voltage input (NPN input), approximately 14 V is output from the input terminals, so connect a diode if the external power supply is less than 14 V.

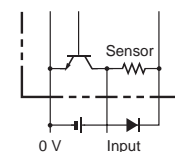

- Install a switch or circuit-breaker that allows the operator to immediately turn OFF the power, and make sure it is labeled clearly.
- The H7CX's panel surface is water-resistive (conforming to NEMA 4, UL Type 4X, and IP66). In order to prevent the internal circuit from water penetration through the space between the H7CX and operating panel, attach a waterproof packing between the H7CX and installation panel and secure the waterproof packing with the Y92F-30 Flush-mounting Adapter.

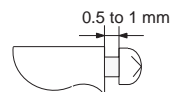

It is recommended that the space between the screw head and the adapter should be 0.5 to 1 mm.

- Tighten the two mounting screws on the Adapter. Tighten them alternately, a little at a time, so as to keep them at an equal tightness. If the panel screws are tightened unequally, water may ingress inside the panel.

■ Precautions for Correct Use

External Power Supply

The capacity of the external power supply is 100 mA at 12 V. When using a 24 VAC/12 to 24 VDC power supply, reduce the load with the power supply voltage, as shown in the following diagram (DC power supplies only).

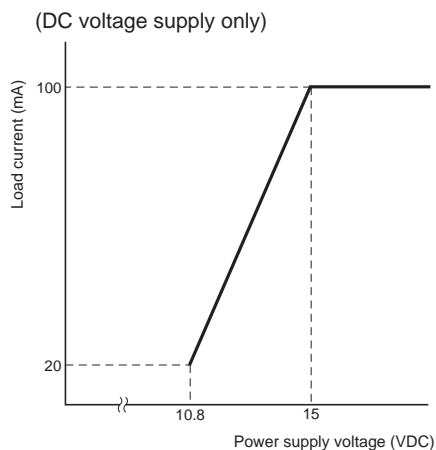

Power Supplies

- Turn the power ON and OFF using a relay with a rated capacity of 10 A minimum to prevent contact deterioration due to inrush current caused by turning the power ON and OFF.
- Be sure that the capacity of the power supply is large enough, otherwise the H7CX may not start due to inrush current (reference value: approx. 10 A, 1.5 ms at 26.4 VAC) that may flow for an instant when the H7CX is turned ON.

Power Failure Backup

All data is stored in the EEPROM when there is a power failure. The EEPROM can be overwritten more than 100,000 times. EEPROM is overwritten when the power is turned OFF or when settings are changed.

■ Conformance to EN/IEC Standards

- Specifications call for basic insulation between the power supply and input terminals, between the power supply and output terminals, and between the input and output terminals. (The H7CX-A□D is not insulated between the power supply and input terminals.)
- Input and output terminals are connected to devices without exposed charged parts.
- Input and output terminals are connected to devices with basic insulation that is suitable for the maximum operating voltage.

Safety Precautions (H7CX-A)

■ Precautions for Safe Use

Changing the Set Values

When changing the set value during operation, because the H7CX uses a constant read-in system, output will turn ON if the set value is equal to the present value.

■ Precautions for Correct Use

Power Supplies

When turning the power ON and OFF, input signal reception is possible, unstable, or impossible as shown in the diagram below.

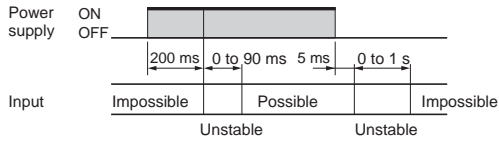

Transistor Output

The transistor output of the H7CX is isolated from the internal circuitry by a photocoupler, so the transistor output can be used as both NPN and PNP output.

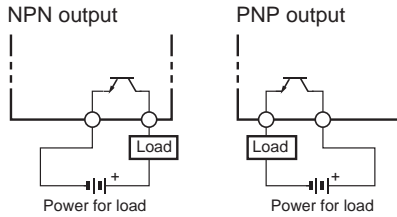

The diode connected to the collector of the output transistor is used to absorb inverted voltage that is generated when an inductive load is connected to the H7CX.

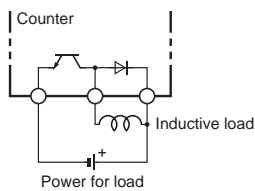

Operation with a Set Value and Present Value of 0

If the set value and present value are both 0, output will turn ON. Output will turn OFF during reset.

Using the Prescaling Function

Observe the following points when setting a prescale value.

- Set the set value to a value less than (Maximum countable value – Prescale value).

Example: If the prescale value is 1.25 and the counting range is 0.000 to 999.999, set the set value to a value less than 998.749 (= 999.999 – 1.25).

- If the set value is set to a value greater than this, output will not turn ON.

Note: Output will turn ON, however, if a present value overflow occurs (FFFFFF or FFFF).

- Setting the prescale value incorrectly may result in incorrect counting operation. Be sure to set the prescale value correctly.

Response Delay Time When Resetting (Transistor Output)

The following table shows the delay from when the reset signal is input until the output is turned OFF.

(Reference values)

Minimum reset signal width	Output delay time
1 ms	0.8 to 1.2 ms
20 ms	15 to 25 ms

Output Delay Time

The following table shows the delay from when the present value passes the set value until the output is produced.

Actual measurements in N and K-2 modes. (Reference values)

Control output type	Maximum counting speed	Output delay time
Contact output	30 Hz	16.5 to 24.0 ms
	5 kHz	3.7 to 5.6 ms
Transistor output	30 Hz	12.0 to 20.0 ms
	5 kHz	0.2 to 0.55 ms

Note: The above times may vary slightly depending on the mode or operating conditions.

Maximum Counting Speed for Batch Counter

The maximum counting speed for batch counter operation is 5 kHz. The batch counter counts the number of times the count reaches the set value.

Safety Precautions (H7CX-R)

■ Precautions for Safe Use

Changing the Measurement Value

The H7CX-R uses a constant read-in system, so the output status is affected when the comparison values are changed during operation such that the present measurement value falls within the range of the upper- and lower-limit comparison values.

Turning ON the Power using the Factory Settings

When the power is turned ON using the factory settings, the output will turn ON after 999.9 s if no pulses are received as count input.

■ Precautions for Correct Use

Comparison Value Settings

In upper and lower limit output mode, if the comparison value setting is such that comparison value 1 \geq comparison value 2, the output will always be ON.

Using the Prescaling Function

Setting the prescale value incorrectly may result in incorrect counting operation. Be sure to set the prescale value correctly.

Warranty and Application Considerations

Warranty and Limitations of Liability

WARRANTY

OMRON's exclusive warranty is that the products are free from defects in materials and workmanship for a period of one year (or other period if specified) from date of sale by OMRON.

OMRON MAKES NO WARRANTY OR REPRESENTATION, EXPRESS OR IMPLIED, REGARDING NON-INFRINGEMENT, MERCHANTABILITY, OR FITNESS FOR PARTICULAR PURPOSE OF THE PRODUCTS. ANY BUYER OR USER ACKNOWLEDGES THAT THE BUYER OR USER ALONE HAS DETERMINED THAT THE PRODUCTS WILL SUITABLY MEET THE REQUIREMENTS OF THEIR INTENDED USE. OMRON DISCLAIMS ALL OTHER WARRANTIES, EXPRESS OR IMPLIED.

LIMITATIONS OF LIABILITY

OMRON SHALL NOT BE RESPONSIBLE FOR SPECIAL, INDIRECT, OR CONSEQUENTIAL DAMAGES, LOSS OF PROFITS, OR COMMERCIAL LOSS IN ANY WAY CONNECTED WITH THE PRODUCTS, WHETHER SUCH CLAIM IS BASED ON CONTRACT, WARRANTY, NEGLIGENCE, OR STRICT LIABILITY.

In no event shall the responsibility of OMRON for any act exceed the individual price of the product on which liability is asserted.

IN NO EVENT SHALL OMRON BE RESPONSIBLE FOR WARRANTY, REPAIR, OR OTHER CLAIMS REGARDING THE PRODUCTS UNLESS OMRON'S ANALYSIS CONFIRMS THAT THE PRODUCTS WERE PROPERLY HANDLED, STORED, INSTALLED, AND MAINTAINED AND NOT SUBJECT TO CONTAMINATION, ABUSE, MISUSE, OR INAPPROPRIATE MODIFICATION OR REPAIR.

Application Considerations

SUITABILITY FOR USE

OMRON shall not be responsible for conformity with any standards, codes, or regulations that apply to the combination of products in the customer's application or use of the products.

Take all necessary steps to determine the suitability of the product for the systems, machines, and equipment with which it will be used.

Know and observe all prohibitions of use applicable to this product.

NEVER USE THE PRODUCTS FOR AN APPLICATION INVOLVING SERIOUS RISK TO LIFE OR PROPERTY WITHOUT ENSURING THAT THE SYSTEM AS A WHOLE HAS BEEN DESIGNED TO ADDRESS THE RISKS, AND THAT THE OMRON PRODUCTS ARE PROPERLY RATED AND INSTALLED FOR THE INTENDED USE WITHIN THE OVERALL EQUIPMENT OR SYSTEM.

Disclaimers

CHANGE IN SPECIFICATIONS

Product specifications and accessories may be changed at any time based on improvements and other reasons. Consult with your OMRON representative at any time to confirm actual specifications of purchased product.

DIMENSIONS AND WEIGHTS

Dimensions and weights are nominal and are not to be used for manufacturing purposes, even when tolerances are shown.

ALL DIMENSIONS SHOWN ARE IN MILLIMETERS.

To convert millimeters into inches, multiply by 0.03937. To convert grams into ounces, multiply by 0.03527.

Cat. No. M070-E1-04

OMRON Corporation

Industrial Automation Company

Industrial Devices and Components Division H.Q.

Industrial Control Components Department

Shiokoji Horikawa, Shimogyo-ku

Kyoto, 600-8530 Japan

Tel: (81)75-344-7119/Fax: (81)75-344-7149

Printed in Japan

0603-3M (1001) (O)