

# Shock Absorber

## Series **RB**

### Features

- ➔ Automatic adjustment to the most appropriate absorption performance
- ➔ High resistance to load deviation
- ➔ Double seal enclosure
- ➔ Compact design



### Specifications

Model	Basic type	RB0805	RB0806	RB1006	RB1007	RB1411	RB1412	RB2015	RB2725
Specifications	With cap	RBC0805	RBC0806	RBC1006	RBC1007	RBC1411	RBC1412	RBC2015	RBC2725
Max. energy absorption (J)		0.98	2.94	3.92	5.88	14.7	19.6	58.8	147
Stroke absorption (mm)		5	6	6	7	11	12	15	25
Collision speed (m/s)		0.05 to 5.0							
Max. operating frequency * (cycle/min)		80	80	70	70	45	45	25	10
Max. allowable thrust (N)		245	245	422	422	814	814	1961	2942
Ambient temperature range (°C)		-10 to 80 (No freezing)							
Spring force (N)	Extended	1.96	1.96	4.22	4.22	6.86	6.86	8.34	8.83
	Retracted	3.83	4.22	6.18	6.86	15.30	15.98	20.50	20.01
Weight (g)	Basic type	15	15	23	23	65	65	150	350
	With cap	16	16	25	25	70	70	165	400

\* It denotes the values at the maximum energy absorption per one cycle.  
Max. operation cycle/min can increase in proportion to energy absorption.

### How to Order

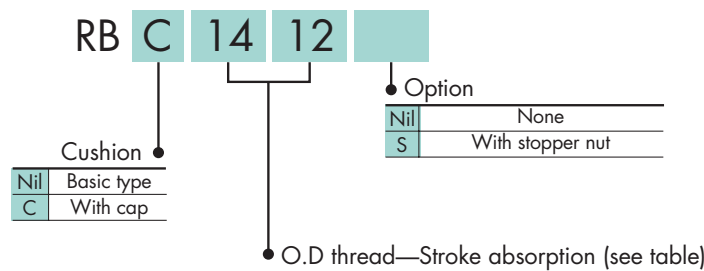

Replacement part no./Cap (Resin part only)

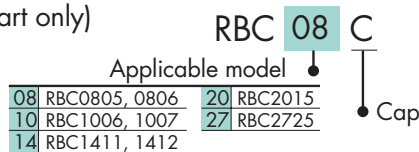

Cap cannot be mounted for basic type. Please place an order with cap type from the beginning.



**Dimensions**

Basic type: RB0805, RB0806, RB1006, RB1007

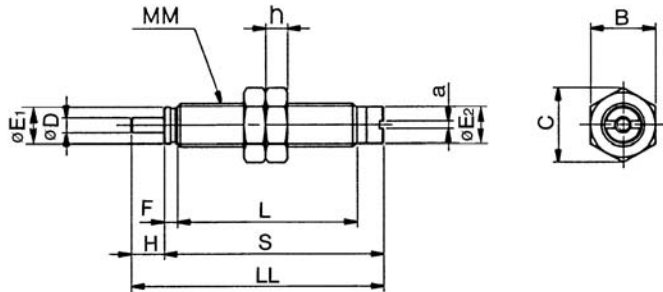
 With cap: RBC0805, RBC0806  
RBC1006, RBC1007

\* Other dimensions are the same as the basic type.

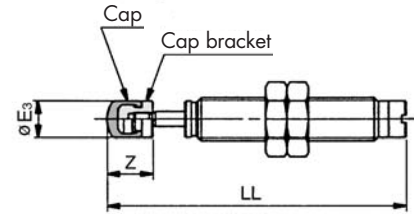

(mm)

Model		Basic type dimensions										With cap*			Hexagon nut		
Basic type	With cap	D	E <sub>1</sub>	E <sub>2</sub>	F	H	a	L	LL	MM	S	E <sub>3</sub>	LL	Z	B	C	h
RB0805	RBC0805	2.8	6.8	6.8	2.4	5	1.4	33.4	45.8	M8 x 1.0	40.8	6.8	54.3	8.5	12	13.9	4
RB0806	RBC0806	2.8	6.8	6.8	2.4	6	1.4	33.4	46.8	M8 x 1.0	40.8	6.8	55.3	8.5	12	13.9	4
RB1006	RBC1006	3	8.8	8.6	2.7	6	1.4	39	52.7	M10 x 1.0	46.7	8.7	62.7	10	14	16.2	4
RB1007	RBC1007	3	8.8	8.6	2.7	7	1.4	39	53.7	M10 x 1.0	46.7	8.7	63.7	10	14	16.2	4

Basic type: RB1411, RB1412, RB2015, RB2725

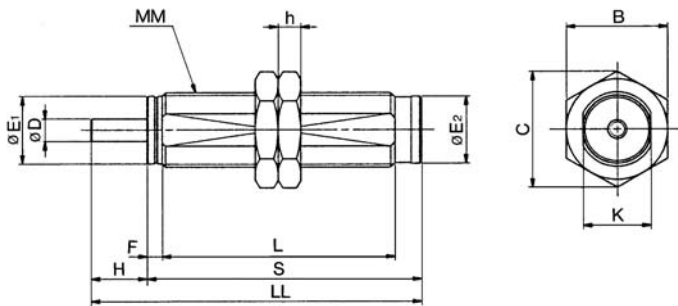
 With cap: RBC1411, RBC1412  
RBC2015, RBC2725

\* Other dimensions are the same as the basic type.

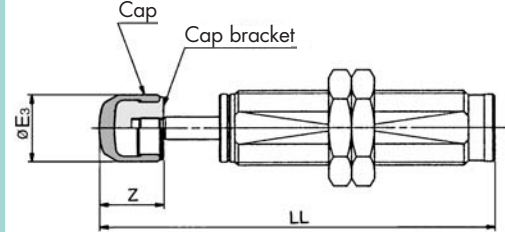

(mm)

Model		Basic type dimensions										With cap*			Hexagon nut		
Basic type	With cap	D	E <sub>1</sub>	E <sub>2</sub>	F	H	K	L	LL	MM	S	E <sub>3</sub>	LL	Z	B	C	h
RB1411	RBC1411	5	12.2	12	3.5	11	12	58.8	78.3	M14 x 1.5	67.3	12	91.8	13.5	19	21.9	6
RB1412	RBC1412	5	12.2	12	3.5	12	12	58.8	79.3	M14 x 1.5	67.3	12	92.8	13.5	19	21.9	6
RB2015	RBC2015	6	18.2	18	4	15	18	62.2	88.2	M20 x 1.5	73.2	18	105.2	17	27	31.2	6
RB2725	RBC2725	8	25.2	25	5	25	25	86	124	M27 x 1.5	99	25	147	23	36	41.6	6

**Hexagon Nut**

(2 pcs. standard equipment)

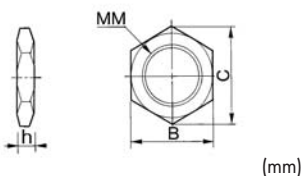

(mm)

Part no.	Dimensions				
	MM	h	B	C	
RB08J	M8 x 1.0	4	12	13.9	
RB10J	M10 x 1.0	4	14	16.2	
RB14J	M14 x 1.5	6	19	21.9	
RB20J	M20 x 1.5	6	27	31.2	
RB27J	M27 x 1.5	6	36	41.6	

**Option**

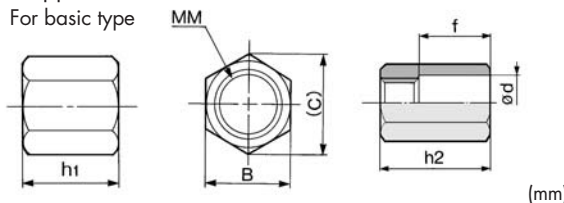
 Stopper nut  
For basic type

(mm)

Part no.	Dimensions								
	Basic type	With cap	B	C	h1	h2	MM	d	f
RB08S	RBC08S	12	13.9	6.5	23	M8 x 1.0	9	15	
RB10S	RBC10S	14	16.2	8	23	M10 x 1.0	11	15	
RB14S	RBC14S	19	21.9	11	31	M14 x 1.5	15	20	
RB20S	RBC20S	27	31.2	16	40	M20 x 1.5	23	25	
RB27S	RBC27S	36	41.6	22	51	M27 x 1.5	32	33	

**Replacement Parts**

Cap

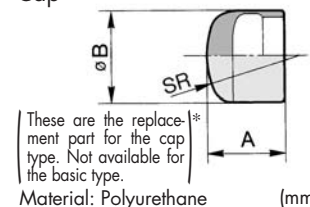

These are the replacement part\* for the cap type. Not available for the basic type.

Material: Polyurethane (mm)

Part no.	Dimensions		
	A	B	SR
RBC08C	6.5	6.8	6
RBC10C	9	8.7	7.5
RBC14C	12.5	12	10
RBC20C	16	18	20
RBC27C	21	25	25