

Multifunction time delay relay

MFT IU14S, IU24S



MFT IU14S

- **7 functions**
- **Zoomvoltage:**
12 ... 240 Vac/dc
- **2 output contacts**

Function

U Multifunction

- E** Delay on
- A** Delay off
- I2** Pulse extension with control contact
- W2** Wiping on trailing edge
- E1** Delay on with control contact
- I1** Pulse limitation timer voltage control
- B2** Cycling timer starting on a pause



MFT IU24S

Time ranges

Adjustable 0,05 s ... 100 h

Output relay

1 or 2 changers potential free 250 Vac / 8 A

Indicators

- Green LED ON: indication of supply voltage
- Green LED flashes: indication of time
- Yellow LED ON/OFF: indication of relay output

Supply voltage

12... 240 Vac/dc -10% +10%

AC 48 ... 63 Hz, 100% duration of operation

Reference data

Selectron® MFT	Article no.
MFT IU14S	41130003
MFT IU24S	41130004
(Order data see chapter 1)	

Multifunction time delay relay

MFT IU14S, IU24S

Technical data	
Input circuit	MFT IU143S, IU24S
	12 ... 240 Vac/dc
	IU14S: 4 VA / 1,5 W IU24S: 6 VA / 2 W
	Residual ripple for dc 10%
	Drop-out voltage >30% of minimum rated supply voltage
Control contact / Voltage controlled	
	Parallel switching of loads possible
	Input not potential free terminals A1 - B1
	Trigger level (sensitivity) automatic adapted to supply voltage
	Max. line length 10 m
	Min. control pulse length DC 50 ms / AC 100 ms
Accuracy	
	Base accuracy ±1% of the scale limit
	Repeatability of the scale limit <0,5% or ±5 ms
	Adjustment accuracy <5% of the scale limit
	Temperature influence ≤0,01% / °C
Reaction times	
	Recovery time 100 ms

Type key

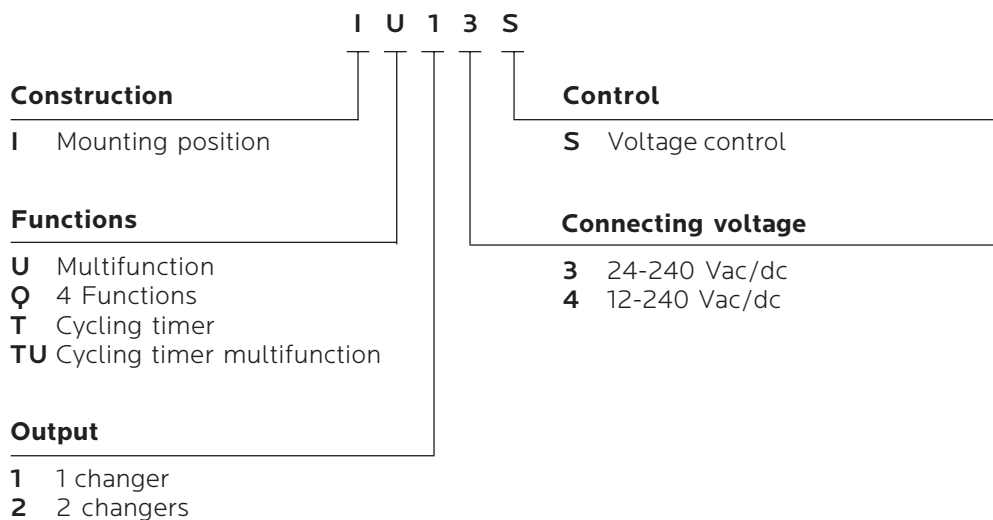

Multifunction time delay relay

MFT IU14S, IU24S

Function descriptions

E - Delay on

When the supply voltage U is applied, the set interval t begins (green LED U/t flashes). After the interval t has expired



(green LED U/t illuminated) the output relay switches into on-position (yellow LED illuminated). This status remains until the supply voltage U is interrupted. If the supply voltage U is interrupted before expiry of the interval t, the interval already expired is erased and is restarted when the supply voltage U is next applied.

A - Delay off

The supply voltage U must be constantly applied to the device (green LED U/t illuminated). When the control contact

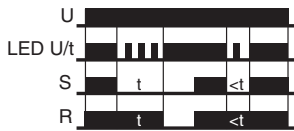

S is closed, the output relay R switches into on-position (yellow LED illuminated). If the control contact S is opened, the set interval t begins (green LED U/t flashes). After the interval t has expired (green LED U/t illuminated) the output relay switches into off-position (yellow LED not illuminated). If the control contact is closed again before the interval t (green LED U/t illuminated) has expired, the interval already expired is erased and is restarted with the next cycle.

I2 - Pulse extension with control contact

The supply voltage U must be constantly applied to the device (green LED U/t illuminated). When the control contact

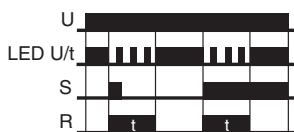

S is closed, the output relay R switches into on-position (yellow LED illuminated) and the set interval t begins (green LED U/t flashes). After the interval t has expired (green LED U/t illuminated) the output relay switches into off-position (yellow LED not illuminated). During the interval, the control contact can be operated any number of times. A further cycle can only be started when the cycle run has been completed.

W2 - Wiping on trailing edge

The supply voltage U must be constantly applied to the device (green LED U/t illuminated). Closing the control

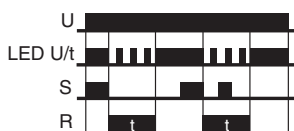

contact S has no influence on the condition of the output relay R. When the control contact is opened, the output relay switches into on-position (yellow LED illuminated) and the set interval t begins (green LED U/t flashes). After the interval t has expired (green LED U/t illuminated), the output relay switches into off-position (yellow LED not illuminated). During the interval, the control contact can be operated any number of times. A further cycle can only be started when a cycle run has been completed.

E1 - Delay on with control contact

The supply voltage U must be constantly applied to the device (green LED U/t illuminated). When the control contact



S is closed, the set interval t begins (green U/tLED flashes). After the interval t has expired (green LED U/t illuminated) the output relay R switches into on-position (yellow LED illuminated). This status remains until the control contact is opened. If the control contact is opened before the interval t has expired, the interval already expired is erased and is restarted with the next cycle.

I1 - Pulse limitation timer voltage control

When supply voltage U is applied, the output relay R switches into on-position (yellow LED illuminated) and the set interval t



begins (green LED U/t flashes). After the interval t has expired (green LED U/t illuminated) the output relay switches into off-position (yellow LED not illuminated). This status remains until the supply voltage is interrupted. If the supply voltage is interrupted before the interval t has expired, the output relay switches into off-position. The interval t already expired is erased and is restarted when the supply voltage is next applied.

B2 - Cycling timer starting on a pause

When the supply voltage U is applied, the set interval t begins (green LED U/t flashes). After the interval t has expired, the



output relay R switches into on-position (yellow LED illuminated) and the set interval t begins again. After the interval t has expired, the output relay switches into off-position (yellow LED not illuminated). The output relay is triggered in the ratio 1:1 until the supply voltage is interrupted.

Multifunctional time delay relay

MFT IU14S, IU24S

Connection

MFT IU14S

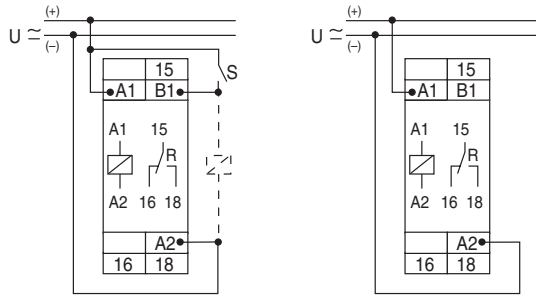

MFT IU24S

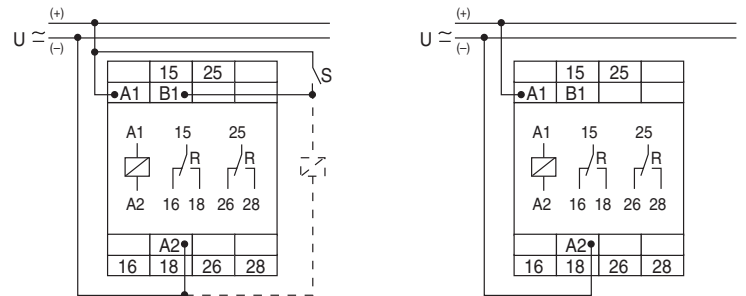

Load limit curves

MFT IU14S

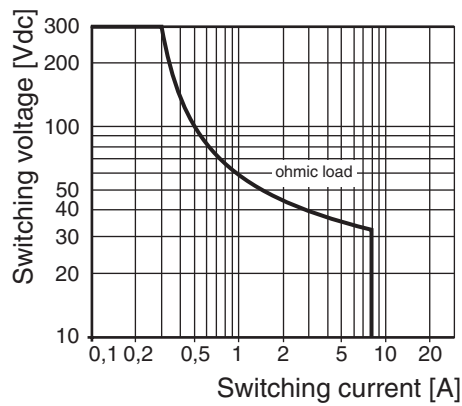

MFT IU24S

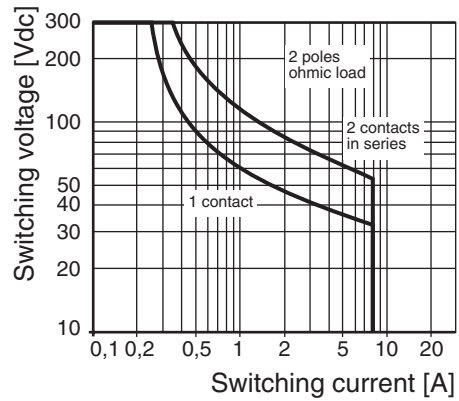

Dimensions

